

All floor and wall coverings should be examined prior to installation for any visible defects. If there are any visible defects, please notify GERFLOR and do not begin installation without its prior approval.

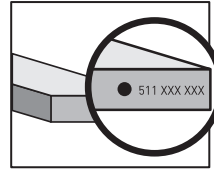

This floor covering must be installed **ONLY** outdoors.

1. INSPECTION AND PREPARATION OF SUBSTRATES

The product may be used on floors meeting the following requirements:

- Plane surface (tolerance threshold of 6 mm under 3 m straight-edge) with a minimum of projections, cracks and bulging elements. Uneven surfaces due to expansion joints, for example, should not exceed 3 mm.
- Surface must not have a slope greater than 1.5%.
- Clean surface before installation: gravel, debris, leaves must be removed. Vegetation must also be treated and adherent dirt cleaned (oils or discharges for example).
- Hard surface that can withstand the stresses of players without tiles becoming embedded in the substrate or without damages because of abrasions of the back of the tiles.

Concretes and asphalt are the most commonly used surfaces.

Concrete paving is often prone to peaks and valleys. To correct a peak, you must grind the area down using a concrete floor grinder or planer. To fill in a valley, you are advised to use a concrete patch binder.

2. PRODUCTS AND ACCESSORIES

2.1 POWERGAME TILE

Powergame tiles join together to form plates.

2.1.1 Tile locking system

The locking system consists of a male peg and a female loop. The peg snaps into the female loop, which holds the tiles together.

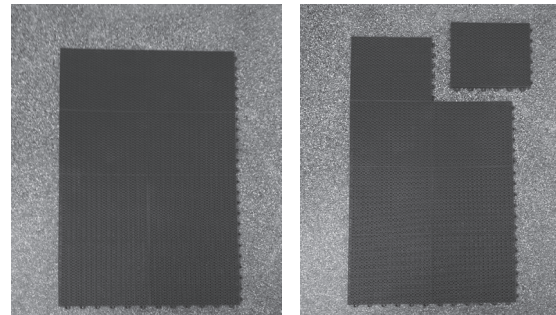
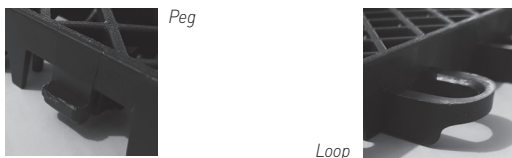

2.1.2 Proper alignment of male pegs and female loops

Properly align the male pegs with the female loops, then apply foot pressure to snap into place.



2.1.3 Correct tile alignment

All tiles should **ALWAYS HAVE THE FEMALE LOOPS GOING IN THE SAME DIRECTION**.

CAUTION: If you inadvertently rotate a tile by 90°, it will snap into place, but you will not be able to complete the installation properly.

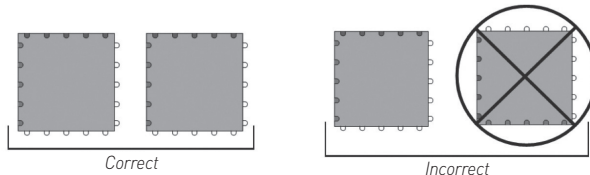

2.1.4 Unclipping of tiles

To easily unclip tiles from a plate, "bend" the tile into 2.

To make it easier, support the back of the tile against your leg protected by work clothing.



To easily unclip tiles placed on the ground, insert a rigid putty knife between the loops and then tilt the spatula to unclip the loop.

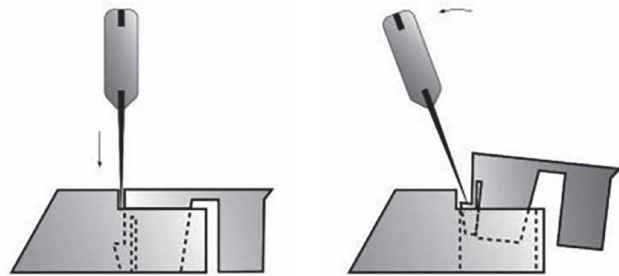

2.2 FINISHING ACCESSORIES

2.2.1 Edge finishing

Depending on the court environment, the expected finish and its exposure, the finishing accessories available on order are:

- Ramps and plastic wedges not attached to the substrate, these accessories are recommended for configurations where the court is not exposed to strong winds.
- "Metal ramp profiles" to be fixed to the substrate; this profile is recommended for configurations where the area of play is exposed to strong winds and to prevent disassembly of the court from its edge. In order to make easier corners, 45° angled mark is performed at the edges of each profile to allow on-site cutting with a circular saw or portable jigsaw.

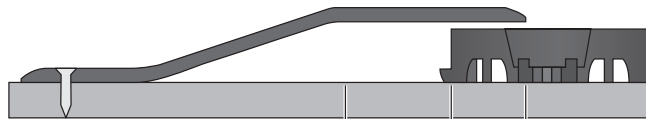
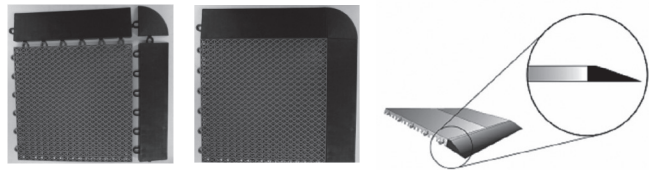

2.2.2 Finishing of post surrounds and anchor points

2.2.2.1 - Post surrounds

An edge clearance around the posts (see § 3.1.2) must be created by cutting the tiles (see § 3.3.1) to allow their expansion during temperature variations.

The finishing of the post surrounds will be done by covering the clearances between the edges of posts and the edges of tiles surrounding the posts (see § 3.3.1).

2.2.2.2 - Anchor points

For courts with removable posts, it is necessary to cut the tiles to the dimensions of the anchor point core by adding the edge clearance (see § 3.1.2).

The tiles being easily removable (see § 2.1.4) we recommend having substitute tiles to completely cover anchor points when these are not used.

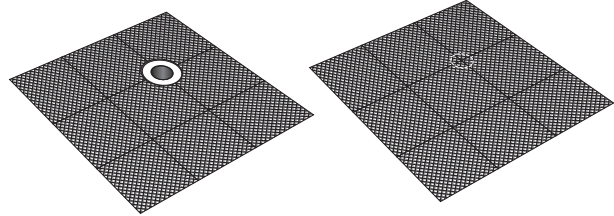

3. INSTALLATION INSTRUCTIONS

■ 3.1.3.1 INSTALLATION PREPARATION

There are many factors to consider before laying the tiles. It is necessary to know the layout of the installation and its equipment in order to envisage the tools to be used and the proper finishing accessories (see § 2.2).

3.1.1 Tools required

The tools below are required for a good installation:

- Utility knife
- Circular saw or portable jigsaw
- Chalk line
- Quintuple decameter
- Plumb bob
- Hammer drill
- Drill adapted to the substrate
- Electric screwdriver
- Rigid putty knife or wood chisel (for disassembly)
- Suitable grinder and cutting disc (case of the use of metal accessories)

3.1.2 Installation analysis

During their life, the tiles will be subjected to different climatic cycles. They could therefore expand or retract depending on temperature variations. Given the size of courts, it is necessary to anticipate its variations to avoid any inconvenience.

To enable the expansion of tiles, a clearance must therefore be provided:

- Around the fixed posts and their points of attachment present on the court,
- Between the ramps and plastic wedges and the edge elements of the court (walls, posts, etc.),
- Under the metal profiles between the edge of the tiles and the edge elements (inclined plane of the ramp profile, walls, posts, etc.).

COURT DIMENSIONS	MINIMUM CLEARANCE BETWEEN TILES OR PLASTIC ACCESSORIES AND FIXED ELEMENTS OF THE COURT	USE OF METAL PROFILES
Length: from 25 to 40 m Width : from 15 to 20 m	7 cm	Allow the tiles to retract, minimum tile coverage must be ensured with metal profiles. See § 3.3.3
Length: from 10 to 25 m Width: from 5 to 15 m	5 cm	

■ 3.2 LAYING OF POWERGAME TILES

3.2.1 Marking the longitudinal axis

Chalk out the longitudinal axis of the court. The chalk line divides the court into two equal halves.

TIP: For basketball courts with fixed baskets, use the plumb bob to mark the centre of the baskets.

TIP: If installing a two-colour basketball court, mark the two free throw lines to determine where the tile colour change takes place.

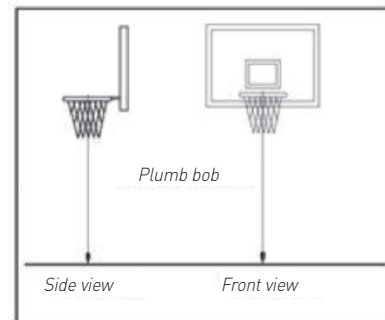
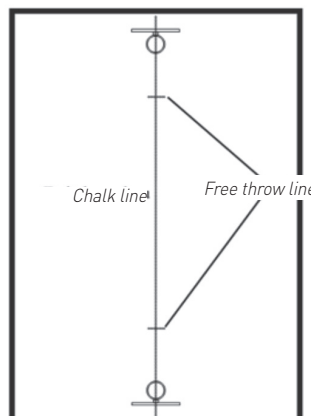

3.2.2 Marking the longitudinal axis

The laying of Powergame must necessarily be done by starting on the longitudinal axis of the court.

- Start laying the row of tiles by placing the male pegs on the chalk line.

TIP: Point the female loops in the directions where the additional tiles will be added.

- Lay the male pegs of the second sheet of tiles on top of the loops of the first sheet laid down.
- Carefully walk on the tiles to lock them into place.
- Continue until the end of the court and work along the longitudinal axis.

TIP: Once the first row of sheets is complete, place full boxes over them to prevent tiles from moving. Full boxes will keep the tiles in place until you have installed three quarters of the court.

- Start the next row of tiles in the same manner as before.

TIP: Depending on the fitters available, after laying the first third of the second row, begin to lay the third row to speed up the installation.

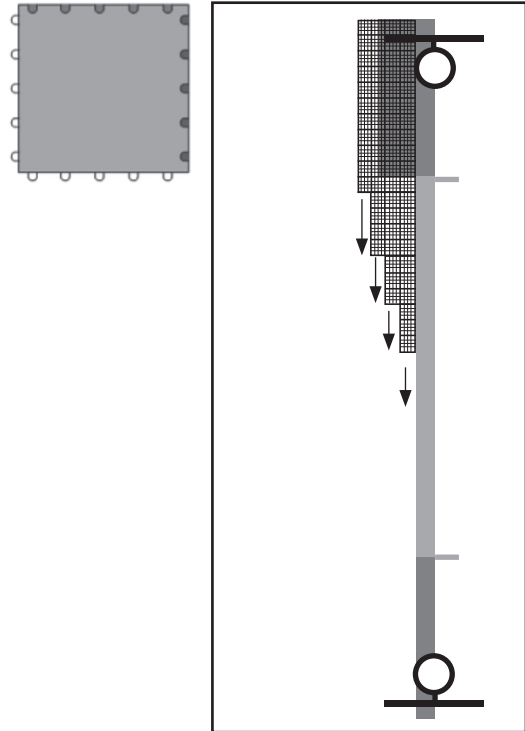

3.2.3 Laying the second half of the court

Laying the second half of the court is done along the width starting from the sideline.

Because of the direction of the tiles, it is necessary to partially lift the first half of the court.

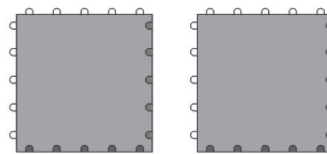
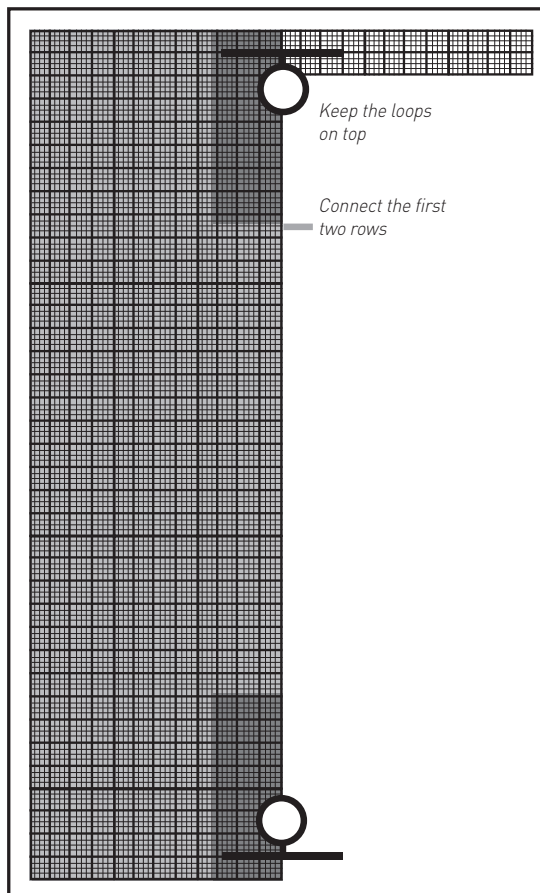

Snapping together

TIPS:

1. Assemble 3 to 5 sheets of Powergame,
2. Gently lift up the first half,
3. Slide the sheet assembly under the raised part,
4. Align the male pegs with the female loops and lock together.

3.2.4 Rolling out

Once the tiles have been laid, the entire surface must be rolled out in both directions using a flooring roller (50 kg). This action makes it possible to have a placement with identical spacing between all the tiles and ensures that the tiles are properly locked together.

3.2.5 Fixing the court

The possible slope of the court and the movement of the players can cause the court to move by sliding on the substrate. To prevent this inconvenience, it is necessary to fix to the substrate on the court from its centre.

For an optimal long-term solution, the fixing must be carried out. In the event of a slope, contact Gerflor's technical departments.

3.2.5.1 - Fixing the central part of the court

The central part of the court must be fixed by a square of 6 tiles by 6 tiles with one attachment point per tile on the edge of the square:

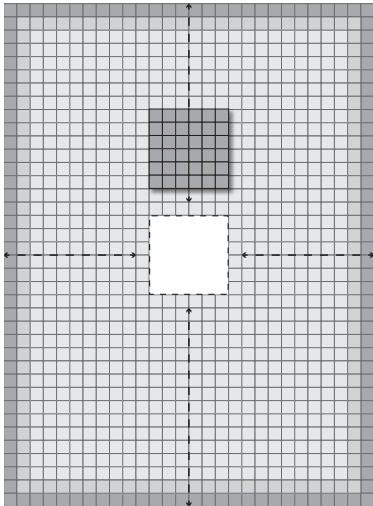

Unclip a square of 6 tiles x 6 tiles.

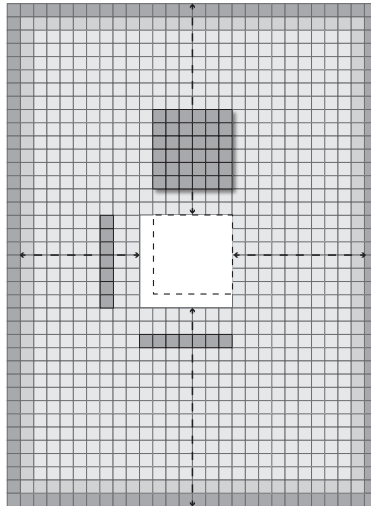

Unclip 2 rows on the side of loops.

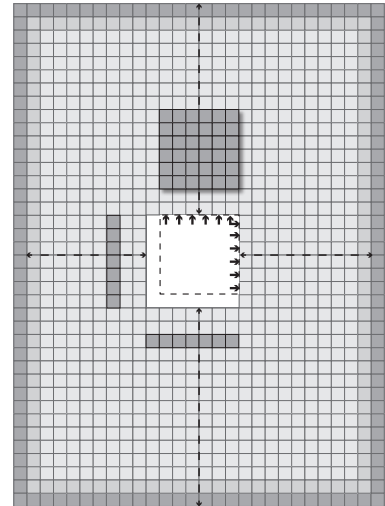

Fix the loops of tiles that have not moved:
1 loop per tile.

Cut the pegs of the tiles corresponding to the loops fixed on the previously unclipped square.

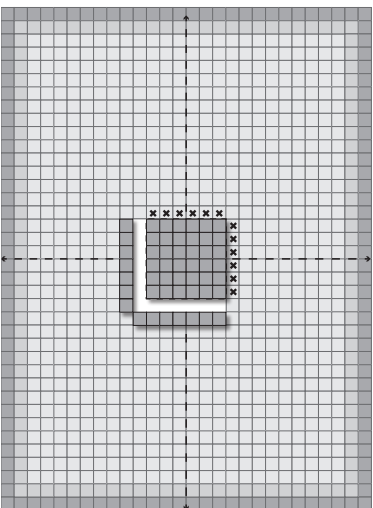

Clip the uncut loops of the tiles of the square
with the corresponding pegs.

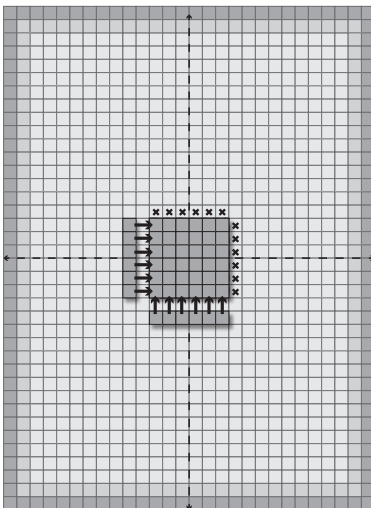

Fix the loops of repositioned tiles:
1 loop per tile.

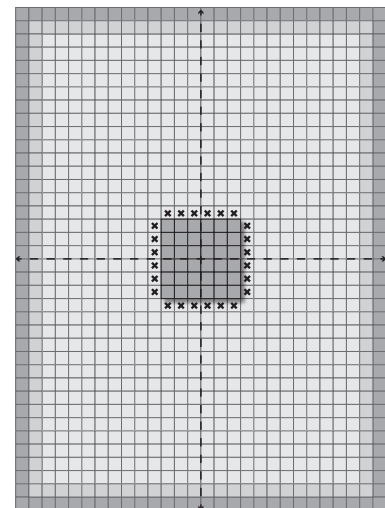

Cut the corresponding pegs on the 2 rows
and reclip these 2 rows.

3.2.5.2 - Cutting of pegs

Pegs must be cut flush with the tile and so as not to interfere with the head of the attachment element that will be used in the corresponding loop. The cut is made using a utility knife.

We recommend fixing the loops with one of the following 2 references:

- Supplier Hilti: Ref. 202342 - Screw HRD - C 8x80 to which a washer of Ext. dia. 24 mm max./Int. dia. 6 mm min. must be added.
- Supplier Hilti: Ref. : 260355 - Screw HPS-1 8/60x90 to which a washer of Ext dia. 24mm max / Int. dia. 6mm min. must be added.

If these references are not available, the attachment element must meet the following requirements:

- Holding depth in the substrate: 80 mm minimum
- Flat screw head and compatible with a washer of ext dia. 24 mm max. / Int. dia. 6 mm,
- Plugging: Opening over the length of the plug,
- Material resistant to external weather conditions.

The loops must be attached as follows:

- Drill the substrate using the drilling machine equipped with a drill adapted to the substrate, respecting the diameter recommended for the pegged screw; use the loop as a guide to ensure proper alignment between the hole and the loop,
- Push the pegged screw into the hole until the end of the plug,
- Finish fixing the loop without crushing it.

3.3 FINISHING THE LAYING

3.3.1 Cutting the tiles

Cutting should always be done on the rib edge to avoid sharp edges.

If no finishing accessory is used, you are advised to trim the loops off the border tiles of completed installations to improve the appearance.

The cuts can be made with a circular saw or a jigsaw.

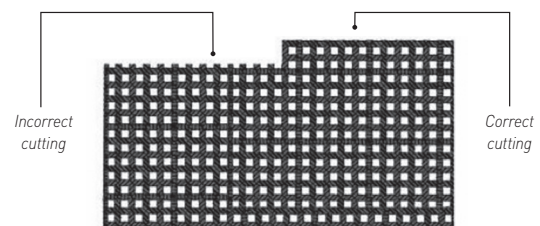
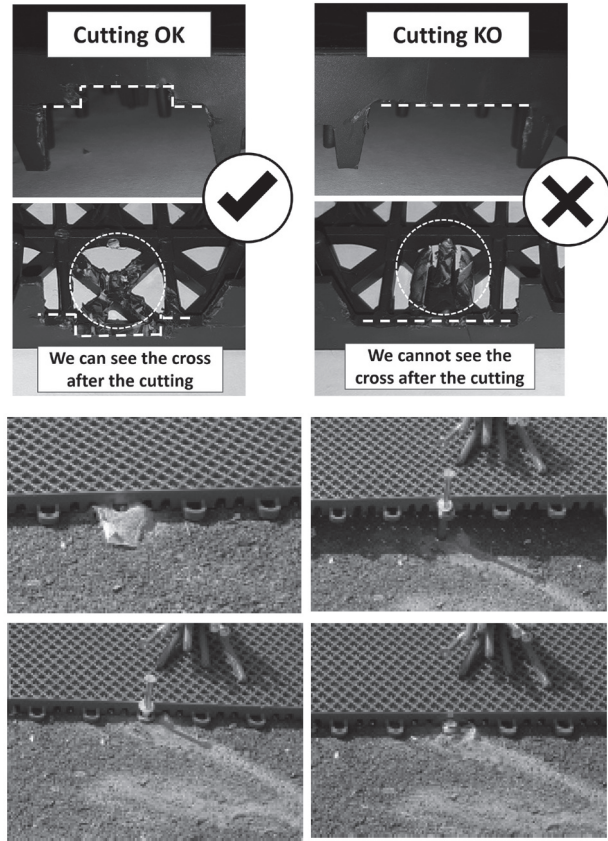

For post surrounds, it is possible to provide a clearance covering between the edge of the tiles and the posts to improve the appearance of the court. In this case, we recommend using either:

Solution n°1

1 square plate cut to be positioned on the post; the cut strip must be riveted to the back of the sheet to close the post surround. Use a grinder and a suitable disc to cut the sheet.

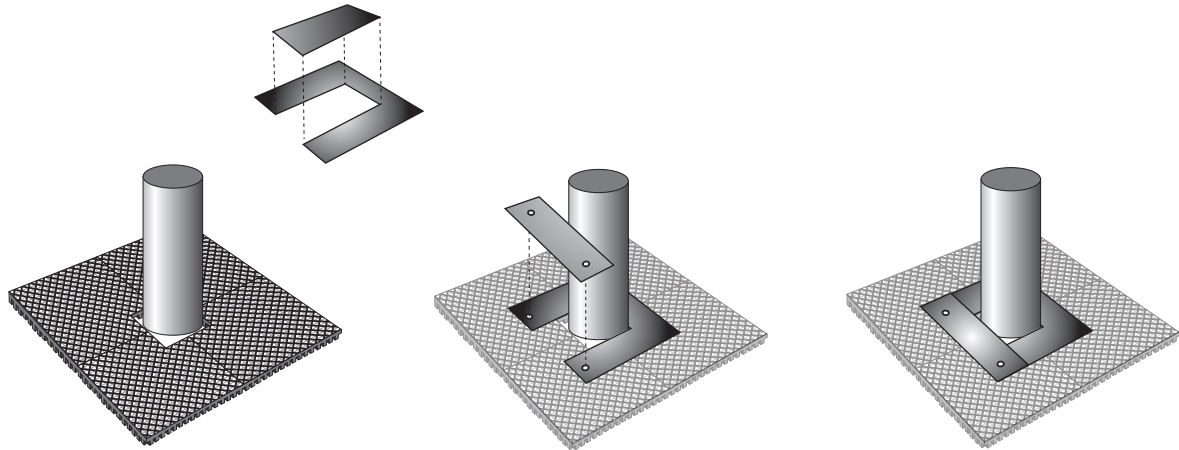

Positioning the sheet cut around the post.

Riveting the cutting on the sheet cut.

Solution n°2

4 rectangular aluminium sheets riveted to one another around the post.

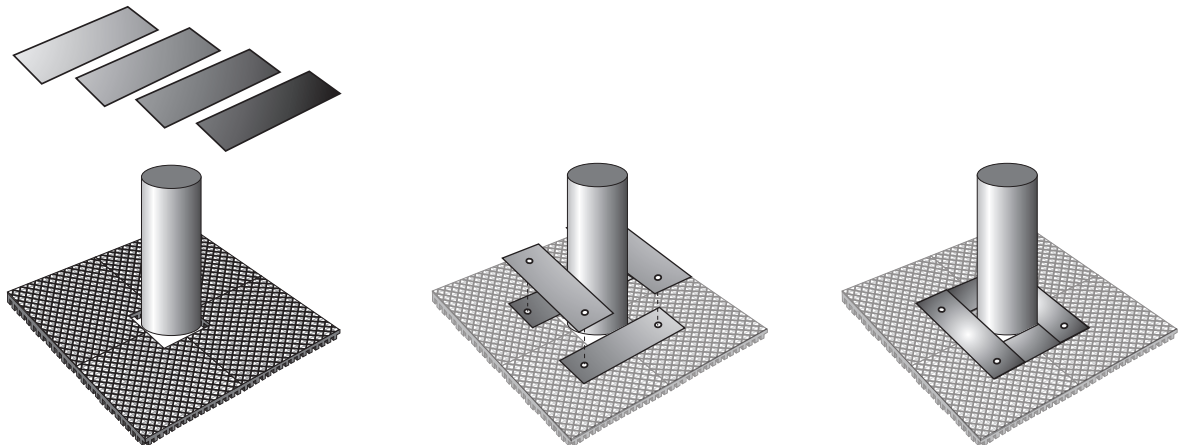

Positioning the sheets around the post.

Riveting the sheets to one another.

Because of the expansion and mobility of tiles, the coverage dimension must be at least twice the clearance left around the posts.

3.3.2 Case of ramps and plastic wedges

Ramps and plastic wedges are clipped and unclipped in the same way as tiles.

3.3.3 Case of metal ramps

To position metal ramps the expansion and retraction of tiles related to temperature variations must be anticipated.

3.3.3.1 - Positioning of ramps

GERFLOR ramps have:

- An oblong hole and a notch on the area covering the tiles to make their positioning easier;
- A series of oblong holes to fix the ramp in the substrate. The edge and centre holes must be fixed. The intermediate holes can be used depending on the state and the constraints of the substrate

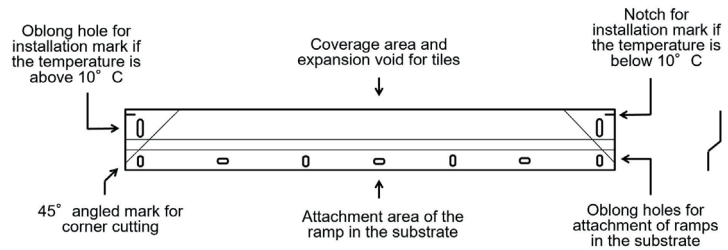

• Case of installations at a temperature below 10°C

The edge of the tile should be aligned with the notch:

- Place the ramps with a larger overlay on the tiles,
- Offset the ramp on the tile to have a visual alignment between the edge of the tile and the notch (fig.1),
- Fix the ramp in the substrate according to this positioning.

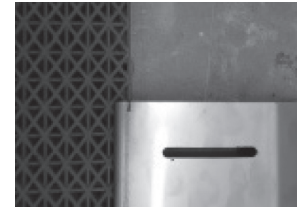

Figure 1

• Case of installations at a temperature above 10°C

The edge of the tile must be aligned with the edge of the oblong hole closest to the tiles. For easier positioning of the ramp, we recommend to:

- Place the ramps with a larger overlay on the tiles,
- Insert a rod in contact with the tile edge in the oblong hole (fig. 2),
- Push the ramp up to the rod to ensure that the overlay is suitable (fig. 3),
- Fix the ramp in the substrate according to this positioning.



Figure 2



Figure 3

If necessary, use a grinder and a disc suitable for cutting metal ramps. These laying rules make it possible to provide for the right spaces for expansion and retraction of tiles.

Should other profiles be used, the values below must be complied with:

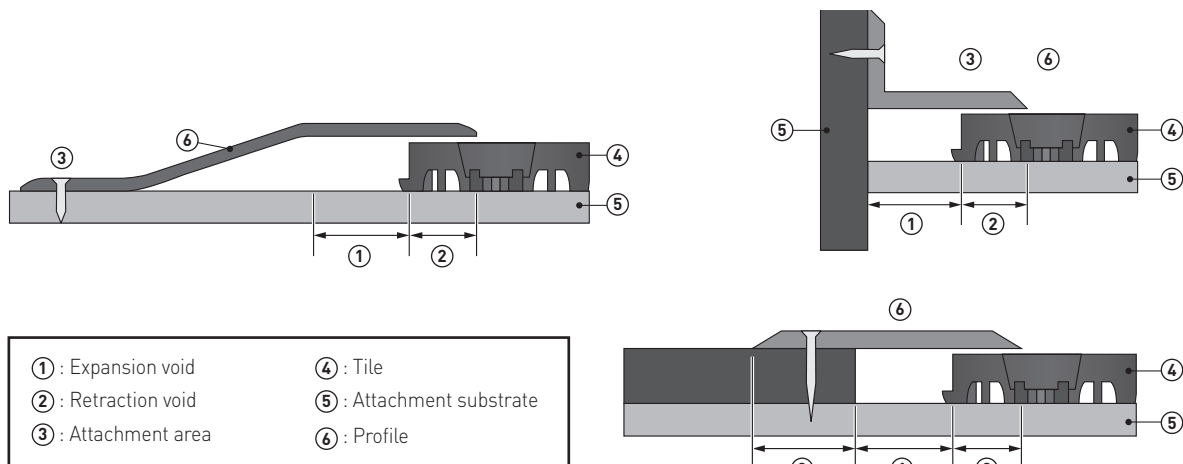

LAYING CONDITIONS	CLEARANCE BETWEEN THE TILES AND SURROUNDING ELEMENTS/TILE COVERING	
Temperature below 10°C	① = 9 cm / ② = 1 cm	① + ② = 10 cm
Temperature above 10°C	① = 7 cm / ② = 3 cm	

3.3.3.2 - Attachment of ramps in the substrate

GERFLOR ramps must be fixed with the oblong holes in contact with the substrate. The edge and centre holes must be fixed. The intermediate holes can be used depending on the state and the constraints of the substrate.

We recommend fixing the GERFLOR ramps with one of the following 2 references:

- Supplier Hilti: Screw HRD – C 8x80 - Ref. 202342
- Supplier Würth: Screw W-UR F8 8x10/80 - Ref. 0912808803

If these references are not available, the attachment element must meet the following requirements:

- Holding depth in the substrate: 80 mm minimum,
- Head diameter of at least 11 mm,
- Plugging: Opening over the length of the plug (not only at its end),
- Material resistant to external weather conditions.

The ramps must be attached as follows:

- Drill the substrate using the drilling machine equipped with a drill adapted to the substrate, respecting the diameter recommended for the pegged screw; use the oblong holes as a guide to ensure proper alignment between the oblong hole and the drilling,
- Push the pegged screw into the hole until the end of the plug,
- Complete the attachment of the ramp by screwing,
- Remove the protective films after the complete laying of the court and before acceptance of the project.

We recommend a space of 2 to 3 mm between each ramp to allow them to expand with temperature variations.

4. INSTALLING GAME LINE PAINT

4.1 NECESSARY EQUIPMENT

Safety elements

- Neoprene rubber or latex gloves,
- NIOSH/MSHA-approved respirator with activated carbon filters.

Equipment and supplies

- Dual roll tape machine (Line-Rite):
- Paint roller (5 cm to 7.6 cm),
- Rubbing alcohol (isopropyl) or acetone.

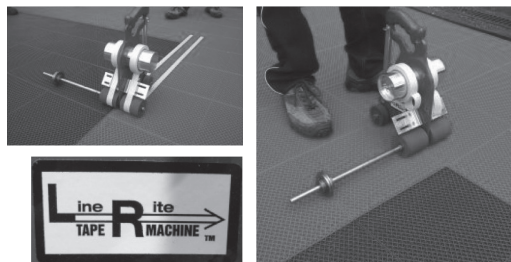

SUPPLIER	PRIMER	PAINT	PACKAGING AND COLOUR
Available by Gerflor CIN https://www.cin.com/	C-THANE PRIMER PL	C-THANE S610 SAT	Primer: 1L. Code: S3420001 Paint ; white: 4L. Code: S3440001
PPG Industries - Porter Paints : https://www.ppgporterpaints.com/	Single component polyurethane primer from supplier	PORTERTHANE 9000 Gloss Urethane	Check with the supplier
DEVOE https://www.devoesuperstore.com/		DEVOE 379 DEVOE 379H	
PPG https://www.ppgpmc.com/		AMERSHIELD PITTHANE ULTRA	
SHERWIN WILLIAM https://www.sherwin-williams.com/		ACROLON 218 HS	

NOTE: Product names may be changed by suppliers without notice. In case of unavailability of these products or impossibility of supply, the paint to be sourced locally must be a two-part high gloss or semi-gloss aliphatic urethane paint which is highly filling and resistant to abrasion and external weathering.

4.2 SAFETY INSTRUCTIONS

1. Use neoprene rubber gloves to protect your hands from direct contact with the primer and paint.
2. The NIOSH/MSHA-approved respirator should cover the mouth and nose tightly. Primer and paint fumes can be dangerous. Change the activated carbon cartridges as soon as fumes are detected inside the mask.

■ 4.3 PAINTING INSTRUCTIONS

4.3.1 Preparation for application

1. Use the tape machine and the recommended tape to frame all lines.
 - a. Press down firmly while applying the tape.
 - b. After all the tape has been applied, remove the tape from the machine and go over all the lines again with the roller to ensure a good seal.

2. Clean the line areas with a cloth that has been dampened with rubbing alcohol or acetone.

4.3.2 Primer

Pre-stir the primer.

- a. Apply the primer to the line areas with a roller or brush as specified until the internal grid.
- b. Allow the primer to dry before applying the paint.

CAUTION: Humidity and temperature affect curing time. Make sure that the primer is dry to the touch before proceeding.

4.3.3 Painting

Mix the two-part polyurethane paint according to the manufacturer's ratio recommendations.

- a. Apply the paint in a thin even coat using the roller or brush as specified until the internal grid between the tape lines.
- b. Avoid squeezing extra paint under the tape or down any seam or void in the tiles.
- c. After the first coat has cured, apply a second coat (as needed). When coating the second level, **care must be taken to ensure that excess paint does not flow to the ground and seal the tiles to the substrate.**

4.3.4 Masking tape removal

Allow the final coat of paint to cure at least 30 minutes before removing the tape. Removing the tape too early may make sections of the paint pull away.

Remove the tape by pulling it straight back over itself, not up at a right angle. Complete drying of the paint: from 2 to 4 days.

■ 4.4 APPLICATION NOTES

Determine the amount of paint needed by calculating the area covered by the game lines and the average consumptions reported by the suppliers.

Application of an excessive quantity of paint (a single thick coat as opposed to several thin coats) can glue the tiles to the substrate, restricting lateral movement and tile interaction caused by thermal expansion and contraction, as well as active play. This can cause buckling and unzipping.

When paint has pooled and locked tiles into place, these must be removed from the substrate and excess paint must be scraped from the concrete.

When tiles are glued together by excess paint, use a putty knife or similar flat instrument to remove the paint without damaging the tiles.

■ 4.5 REPAINTING LINES

Clean the floor covering according to the maintenance instructions (minimum "basic cleaning of tiles", "deep cleaning" if necessary).

For lines with peeling paint:

Peel off the paint by sticking a 5-cm wide adhesive tape. Finish using a chemical paint stripper with a stiff bristle nylon brush. The jagged edges of the flakes could cause early defects in the paint.

For lines where the paint is in relatively good condition, but worn, apply a coat of paint after sanding it. After preparing the surface and removing the old paint, clean the tiles with rubbing alcohol or acetone to remove any residue.

Reproduce the operations in Section 4.3.