

# COMMERCIAL FLOORING SOLUTIONS



---

## 2021 COLLECTION



**Gerflor**<sup>®</sup>  
theflooringgroup

## FORMATS

### With foam backing (Comfort)

 Comfort	 Comfort Textile backing	 Comfort
ROLL	ROLL	STEP

### Without foam backing (Compact)

 Compact	 Compact	 Compact	
ROLL	TILE	INTERLOCKING LOOSELAY TILE	

## PERFORMANCES

<b>17 dB</b> SOUND INSULATION IN dB (EN ISO 717/2)	<b>R10</b> SLIP RESISTANCE WET (DIN 51130)
--	--

<b>10<sup>5</sup></b> ELECTRICAL RESISTANCE IN Ω: 5 X 10 <sup>4</sup> ≤ Rt ≤ 10 <sup>6</sup> (EN 1081/DIN 51953)	<b>10<sup>7</sup></b> ELECTRICAL RESISTANCE IN Ω: 10 <sup>6</sup> ≤ Rt ≤ 10 <sup>9</sup> (EN 1081/DIN 51953)	 VERY HIGH DENSITY FOAM
---	---	---

 <b>100% recyclable</b> 100% RECYCLABLE FLOORING	
---	--

## TREATMENTS



 MICRO STRUCTURED CROSS COAT POLYMERISED LASER TECHNOLOGY	 POLYURETHANE SURFACE TREATMENT UV CURED STAIN SHIELD MATT EFFECT	<b>Protecsol®</b> POLYURETHANE SURFACE TREATMENT UV CURED
--	--	--

<b>PUR+ Matt</b> POLYURETHANE SURFACE TREATMENT MATT SURFACE	<b>PUR+</b> POLYURETHANE SURFACE TREATMENT	<b>PUR</b> POLYURETHANE SURFACE TREATMENT	<b>SparClean®</b> POWDER COATED TREATMENT
---	---	--	---

 NEW EXCLUSIVE LINOLEUM SURFACE PROTECTION	
---	--

## CERTIFICATION



 Bfl-s1	 Bfl-s1	 Bs2d0		 ≤10 <sup>9</sup> Ω	 ≤10 <sup>9</sup> Ω	 DS		
FIRE RESISTANCE	FIRE RESISTANCE	FIRE RESISTANCE	STATIC ELECTRICAL PROPENSITY	ELECTRICAL RESISTANCE	ELECTRICAL RESISTANCE	SLIP RESISTANCE	THERMAL CONDUCTIVITY	WATER RESISTANCE

Scale reduction for Wood designs.

The images of floorcoverings in this catalogue have been reproduced as faithfully as printing technology permits.

Linoleum Uni Walton  
0100 Ocean Blue



# GLOSSARY

## ▶ MIPOLAM HOMOGENEOUS

P.8

### ▶ Evercare™

- Mipolam Symbioz™
- Mipolam Planet & Bioplanet **NEW**
- Mipolam Elegance
- Mipolam Affinity
- Mipolam Accord
- Mipolam Cosmo
- Mipolam Troplan

### ▶ PUR

- Mipolam Classic

## ▶ PREMIUM

P.36

- Poesy
- Neopolis
- Osmoz
- Indiana
- Metallica
- Brazilia
- My Premium
- Dry-Text™ System
- Attraction® Premium

## ▶ TARALAY MULTILAYERED

P.52

### ▶ Taralay Libertex

- Amsterdam
- Cocoon
- Hossegor
- Legend
- Paros
- Pure Oak
- Reflect
- Skandi Oak

### ▶ Taralay Impression

- Corner
- Kubes
- Rice
- Stars
- Cemento
- Mohair
- Nest
- Trame
- Gentlemen
- Wood
- Leather
- Uni Matt

### ▶ Taralay Initial

- NEW**
- Diversion
- Miami
- Spider
- Urban
- Strada
- Wood

### ▶ Timberline

- Wood
- Pixel

### ▶ Tarastep

## ▶ CREATION LVT

P.100

### ▶ Creation 70

- Creation 70
- Creation 70 Clic
- Creation 70 Looselay
- Creation 70 Connect

### ▶ Saga²

### ▶ Creation 55

- Creation 55
- Creation 55 Clic
- Creation 55 Looselay
- Creation 55 Looselay Acoustic

### ▶ Rigid 55 Lock Acoustic

### ▶ Creation 30

- Creation 30
- Creation 30 Clic

### ▶ Rigid 30 Lock

### ▶ TopSilence Design

## ▶ TECHNICAL TILES

P.176

### ▶ GTI MAX

### ▶ GTI EL5

### ▶ Attraction®

- Neopolis
- Brazilia
- Indiana
- Osmoz

## ▶ TECHNICAL SOLUTIONS

P.192

### ▶ EL5 / EL7 solutions

[Dissipative & conductive floors]

- Mipolam EL7
- Mipolam Robust EL7
- Mipolam EL5
- Mipolam Technic EL5
- GTI EL5

### ▶ Safety flooring

- Tarasafe Geo
- Tarasafe Ultra & Ultra Comfort
- Tarasafe Standard
- Tarasafe Plus/Super
- Tarasafe Ultra H2O

### ▶ Shower System

- Elegance SD
- Tarasafe Ultra H2O
- Mural Calypso

### ▶ Wall Covering

- Mural Ultra
- Mural Club
- Mural Calypso

## ▶ DLW LINOLEUM

P.216

### ▶ Compact Linoleum

- Arabesque
- Marmorette
- Colorette
- Uni walton
- Lino Art Urban
- Lino Art Flow
- Lino Art Metallic
- Lino Art Star

### ▶ Acoustic Linoleum

- Marmorette Acoustic
- Marmorette AcousticPlus
- Colorette AcousticPlus

### ▶ Technical Solutions

- High mechanical Traffic Linodur
- Dissipative Linoleum
- Marmorette LCH

## ▶ SPORT FLOORING

P.246

### ▶ TARAFLEX® Synthetic Sport Flooring

### ▶ CONNOR SPORTS® Hardwood Flooring Systems

### ▶ SPORT COURT® Outdoor Surfaces

### ▶ DLW Linoleum Sport Flooring

### ▶ POWERSHOCK Fitness Rubber Solutions

## ▶ FINISHES

P.282

### ▶ Finishes

- Skirting solutions
- Stair solutions
- Profile solutions
- Welding solutions
- Entrance mats solutions

### ▶ Installation solutions

- Shower system
- Accessibility
- Acoustic underlayers
- Specific products
- Adhesives and tapes

### ▶ Sport finishes

- Paint and marking for boundary lines

## ▶ SPECIFICATIONS

P.314

Since 1937, Gerflor **has designed, manufactured and distributed design-led, innovative and eco-responsible** floor coverings and wall protection solutions.

Present in more than **100 countries**, with **4,200 employees, 29 subsidiaries** and **12 production sites**, Gerflor serves many activity sectors including health, education, residential accommodation and sport.

## WORLDWIDE PRESENCE FOR BETTER SERVICE

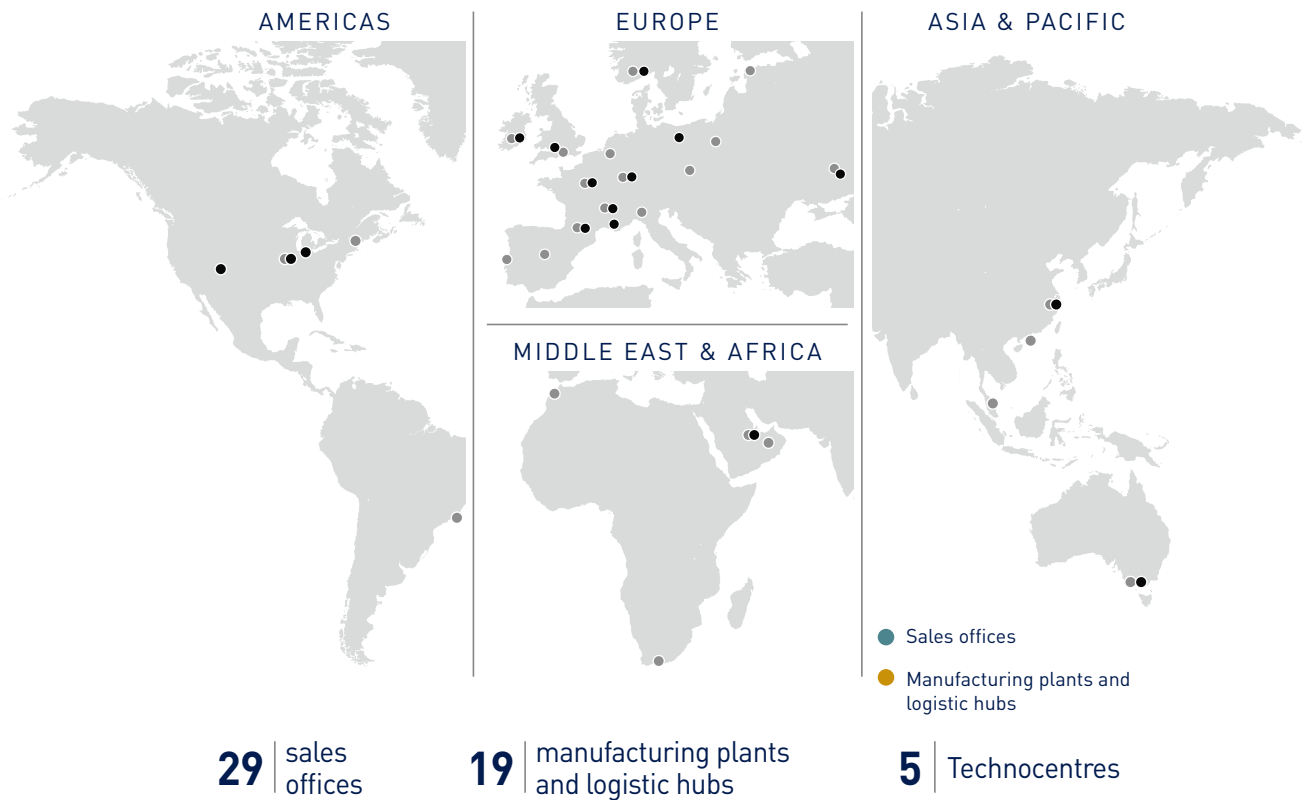

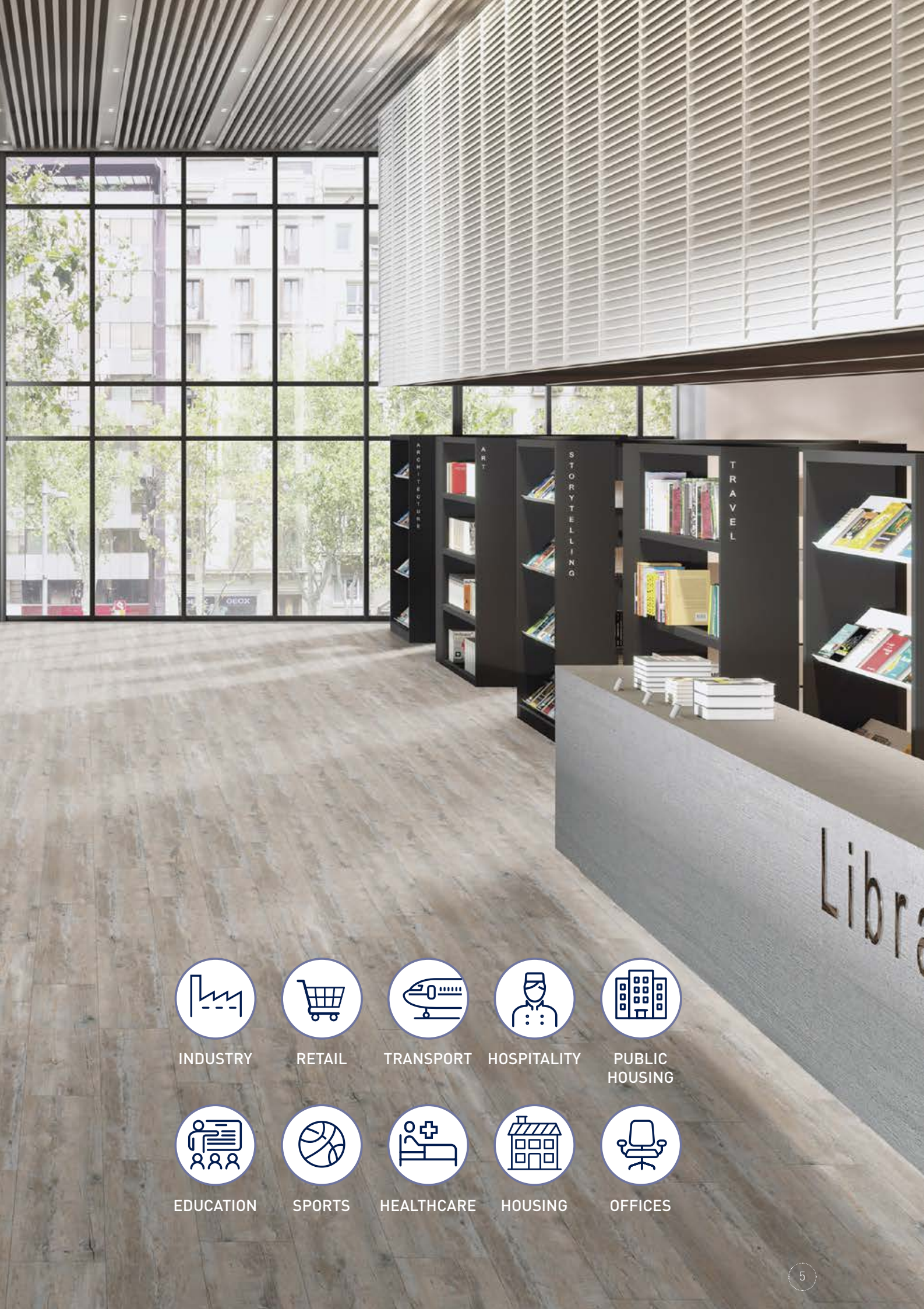

INDUSTRY



RETAIL



TRANSPORT



HOSPITALITY



PUBLIC  
HOUSING



EDUCATION



SPORTS



HEALTHCARE



HOUSING



OFFICES



# OUR COMMITMENTS FOR A SUSTAINABLE FUTURE

---

Gerflor teams have always considered customers and the environment as their absolute priorities. Our floor coverings, wall solutions and finishing components are user friendly, healthy solutions. They are designed with respect for our planet to last as long as possible with proposed end-of-life options. From product design through end-of-life, the circular economy is a core priority for the group. We have determined 5 priority commitments to guide our environmental management up to 2025.

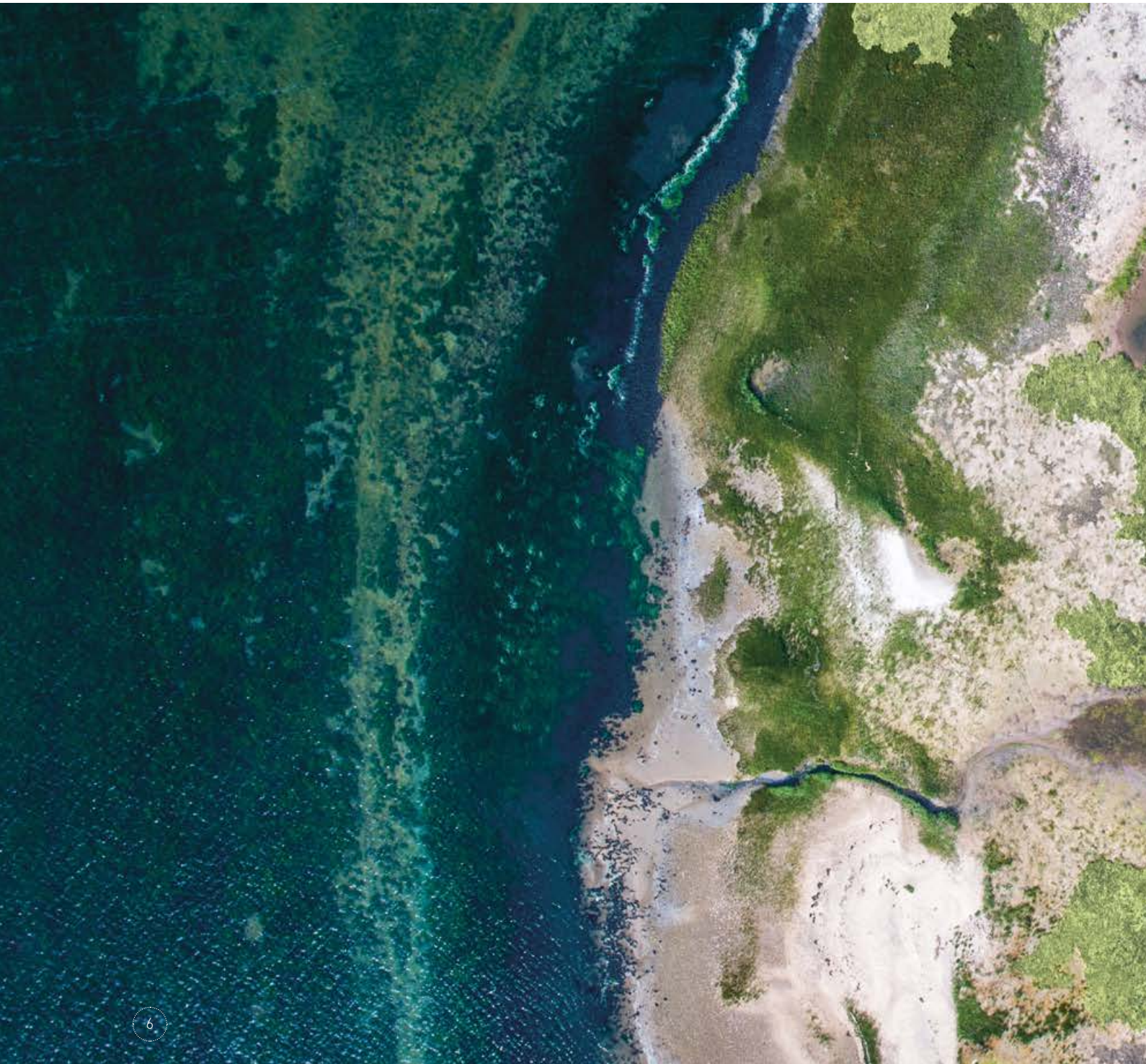



# WE CARE | WE ACT.

Our commitments for a sustainable future



## CARBON FOOTPRINT\*

-20% kg  
CO<sub>2</sub> equivalent/m<sup>2</sup>  
between 2020 and 2025



## BIOSOURCED CONTENT\*\*

5% in 2020  
10% by 2025



## RECYCLED CONTENT

25% in 2020  
30% by 2025



## ADHESIVE FREE\*\*\*

25% in 2020  
35% by 2025



## ANNUAL VOLUME RECYCLED

50,000 t in 2020  
60,000 t by 2025

\* Scopes 1 & 2 defined in the GHG protocol

\*\* % of activity with biosourced materials

\*\*\* % of activity with adhesive free solutions







.....

MIPOLAM  
HOMOGENEOUS

..... PAGES .....

**8 / 35**

.....





## Mipolam Homogeneous Evercare™ .....

- Mipolam Symbioz™ 14
- Mipolam Planet & Bioplanet **NEW** 18
- Mipolam Elegance 24
- Mipolam Affinity 26
- Mipolam Accord 30
- Mipolam Cosmo 32
- Mipolam Troplan 33

## Mipolam Homogeneous (PUR) .....

- Mipolam Classic 35

# MIPOLAM HOMOGENEOUS

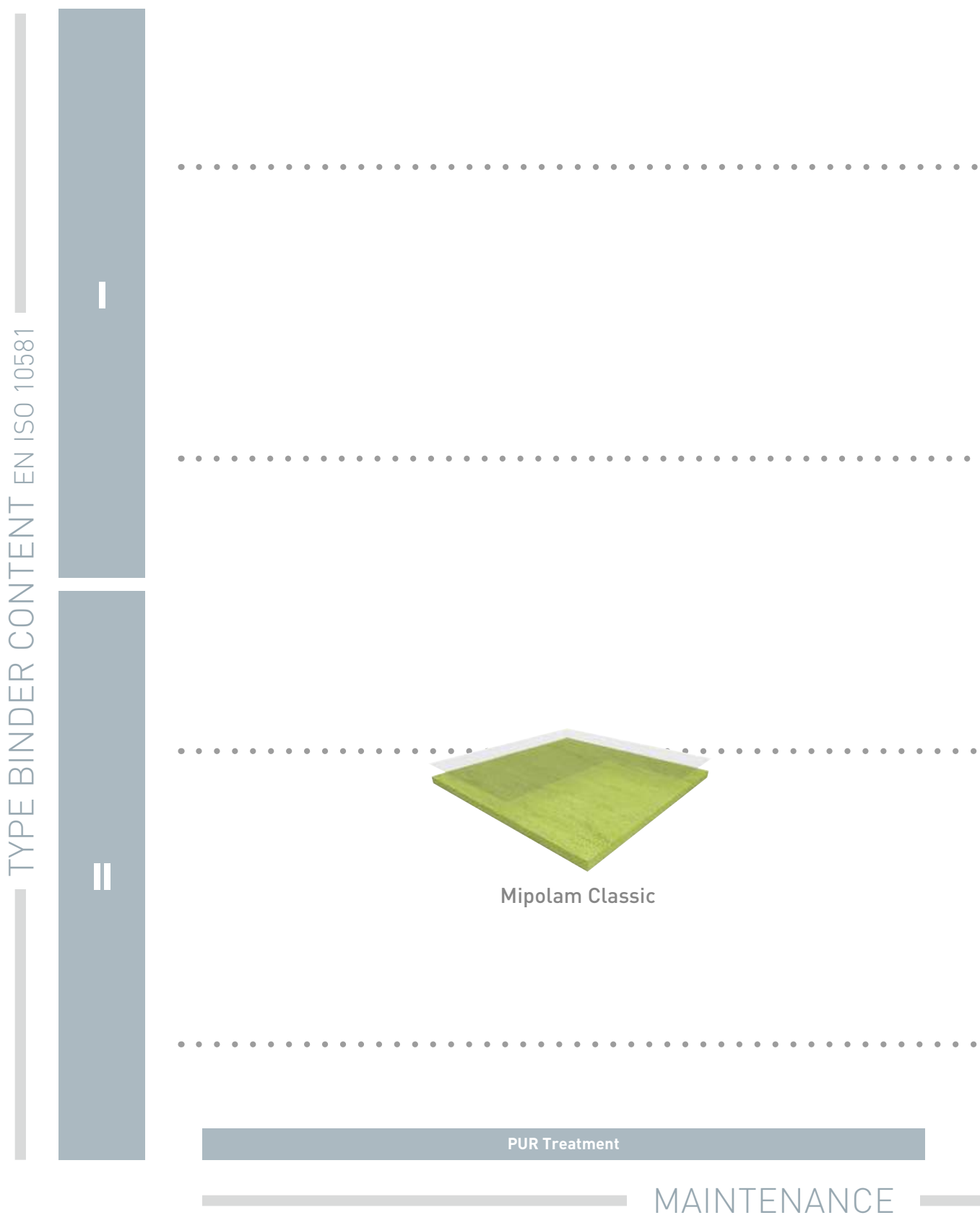



Mipolam Elegance  
Mipolam Affinity  
Mipolam Accord

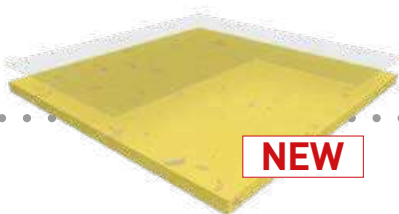

Mipolam Planet  
Mipolam Bioplanet



BIO CONTENT 17%

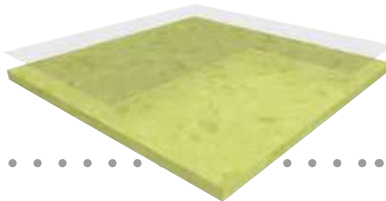

Mipolam Symbioz™



BIO CONTENT 17%



Mipolam Cosmo

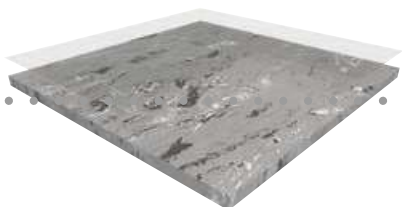

Mipolam Troplan



An exclusive and Gerflor patented surface treatment.



Stain shield



No wax for life  
Water and detergent savings



Matt effect:  
enhanced design



Anti-bacterial &  
anti-viral activity  
ISO 22196 & ISO 21702

Evercare™ Treatment



# MIPOLAM HOMOGENEOUS

## MIPOLAM SYMBIOZ™



### MIPOLAM SYMBIOZ™

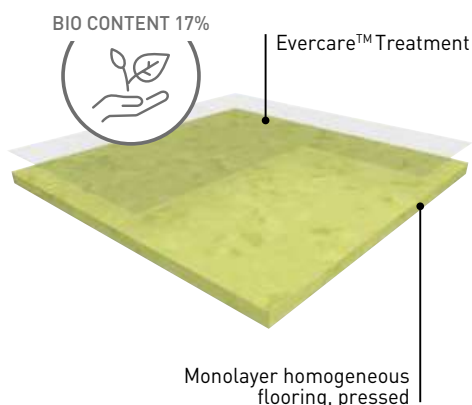

**MIPOLAM SYMBIOZ™** is fully flexible homogeneous compacted floorcovering in sheet, 2 m wide, providing excellent resistance to wear and tear in high traffic areas. Their weight is **2595 gr/m<sup>2</sup>**. They feature a non-directional design incorporating coloured chips to ensure an even colour throughout the thickness presenting **a nice matt finish**.

**MIPOLAM SYMBIOZ™** contain over 75% sustainable of renewable raw materials. They include a 100% bio based plasticizer, made of residues from cereals (wheat, corn...). It is 100% phthalates free and recyclable. This floorcovering is a non-emissive product (below the level of VOC measurement accuracy).

According to ISO 21702, Mipolam Symbioz has **anti-viral activity** against Human Coronaviruses: it reduces the number of virus by 99.7% after 2h00. According to ISO 22196, Mipolam Symbioz has **anti-bacterial activity** against E. coli, S. aureus and MRSA of 99% after 24h00.

The flooring is equipped with **Evercare™**, patented surface treatment obtained by **UV laser cross-linking** offering **the best chemical resistance to the main products used in healthcare** environment as Betadine, eosin, hydro alcoholic solutions, making the maintenance easy and long lasting the flooring. This treatment **avoids applying any acrylic emulsion** throughout the lifetime of the product.

The flooring is **antistatic** (< 2 kV), its residual indentation is ≈ 0.02 mm.

The flooring complies with the EN ISO 10581 norm, has a binder content Type I and is suitable for heavy duty traffic areas and **Bfl-s1 fire** resistance. As part of our sustainable development policy, this product is manufactured in the first floor covering plant awarded with the triple certification: ISO 9001 (quality), ISO 14 001 (environment) and OHSaS 18001 (safety).



#### **BBR40:**

100% Bio-based plasticizer rod for Mipolam Symbioz™  
(see page 295)

# MIPOLAM SYMBIOZ™



Evercare™



100% recyclable

**Mipolam Symbioz™ have been engineered using a full life cycle model, to guarantee the lowest environmental impact at every stage of the product life**

- ▶ **Highest durability:** product life expectancy > 20 years
- ▶ **Eco-responsible exclusive Bio based plasticizer**, 100% made from organic source
- ▶ **Evercare™:** patented polyurethane surface treatment with unique performance in staining providing chemical resistance
- ▶ **Easy maintenance:** no wax for life
- ▶ **On average 30% savings on maintenance cost**
- ▶ **15% less detergent and water use.**

**Indoor Air Quality: very low emitting material (40 times lower than European standards).**

## MIPOLAM SYMBIOZ™

DESCRIPTION			
Total thickness	EN ISO 24346	mm	2
Weight	EN ISO 23997	g/sqm	2595
Width of sheet	EN ISO 24341	cm	200
Length of sheet	EN ISO 24341	lm	20
CLASSIFICATION			
Norm / Product specification	-	-	EN ISO 10581
European classification	EN ISO 10874	class	34-43
Fire rating	EN 13501-1	class	Bfl-s1
Static electrical propensity	EN 1815	kV	< 2
Slip resistance	DIN 51130	class	R9
PERFORMANCES			
Type Binder content	EN ISO 10581	type	I
Dimensional stability	EN ISO 23999	%	≤ 0.40
Impact Sound Insulation	EN ISO 717-2	dB	5
Residual indentation (norm)	EN ISO 24343-1	mm	≤ 0.10
Residual indentation (average measured value)	-	mm	≈ 0.02
Castor chair test (type H)	ISO 4918	-	OK
Thermal conductivity	EN ISO 10456	W/(m.k)	0.25
Colour fastness	EN 20 105 - B02	degree	≥ 6
Surface treatment	-	-	Evercare™
Chemical products resistance	EN ISO 26987	class	OK
Anti-bacterial activity (E. coli - S. aureus - MRSA) after 24h <sup>(1)</sup>	ISO 22196	-	> 99% inhibits growth
Anti-viral activity (human coronavirus) after 2h <sup>(1)</sup>	ISO 21702	-	> 99.7% virucidal activity
ENVIRONMENT / INDOOR AIR QUALITY			
TVOC after 28 days	ISO 16000-6	microgram/m <sup>3</sup>	< 10
Certification	-	-	Floorscore®
CE MARKING			
	EN 14041		

<sup>(1)</sup> The implementation of an effective cleaning regime is the most important defence against infection.

# MIPOLAM HOMOGENEOUS

## MIPOLAM SYMBIOZ™

Compact | Evercare™ | 100% recyclable | BIO CONTENT 17%



6027 Acacia

^ Scale 1



6027 Acacia





6002 Lipica



6030 Stonehenge



6001 Cotton



6009 Grey Stone



6050 Hurricane



6056 Tulum

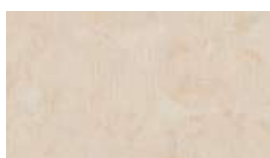

6005 Ghibli



6008 Calico



6036 Oceania



6058 Vermiglio



6031 Breeze



6010 Mist



6037 Lagoon



6018 Ushuaia



6034 Mole



6029 Cloud



6006 Blue Sky



6075 Cardinal

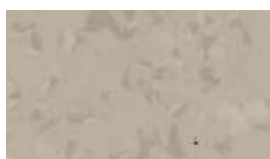

6041 Clay



6039 Pebble



6047 Sauge



6065 Segesta



6043 Wood

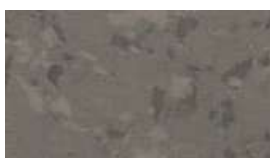

6044 Sea Storm



6057 Musk



6025 Tangelo

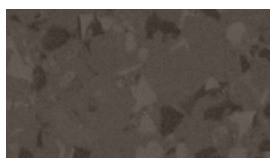

6045 Chocolate



6059 Black Diamond



6067 Kaki



6032 Sunshine



# MIPOLAM HOMOGENEOUS

## MIPOLAM PLANET & BIOPLANET New

### ▶ MIPOLAM PLANET & BIOPLANET

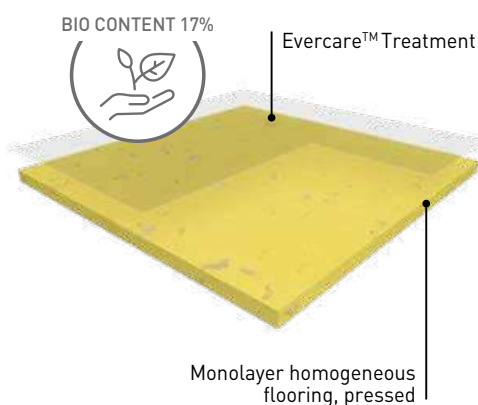

**MIPOLAM PLANET** is fully flexible homogeneous compacted floorcovering in sheet, 2 m wide, providing excellent resistance to wear and tear in high traffic areas. Their weight is **2700 gr/m<sup>2</sup>**.

They feature a non-directional design incorporating translucent chips that provides a 3D effect and ensures an even colour throughout the thickness presenting a nice matt finish over 40 colours.

The flooring is equipped with **Evercare™**, patented surface treatment obtained by UV laser cross-linking offering the best chemical resistance to the main products used in healthcare environment as betadine, eosin, hydro alcoholic solutions, making the maintenance easy and the floor long lasting. This treatment avoids applying any acrylic emulsion throughout the lifetime of the product.

It is free of formaldehyde, heavy metals and CMR 1 & 2 or vPvB (very persistent and very bio-accumulative) or PBT (persistent, bio-accumulative and toxic) and is REACH compliant. It is **100% phthalates free and recyclable**. Its VOC emissions after 28 days (ISO 16000-6) are below detection levels (< 10 microgram/m<sup>3</sup> and g/m<sup>3</sup>) and this product is classified A+ (the best class). According to ISO 21702, Mipolam Planet has **anti-viral activity** against Human Coronaviruses: it reduces the number of virus by 99.7% after 2h00. According to ISO 22196, Mipolam Planet has **anti-bacterial activity** against E. coli, S. aureus and MRSA of 99% after 24h00.

The flooring is **antistatic** (< 2 kV), its residual indentation is ≈ 0.02 mm.

The flooring complies with the EN ISO 10581 norm, has a binder content Type I and is suitable for heavy duty traffic areas and **Bfl-s1 fire resistance**. As part of our sustainable development policy, this product is manufactured in the first floor covering plant awarded with the triple certification: ISO 9001 (quality), ISO 14 001 (environment) and OHSaS 18001 (safety).

**MIPOLAM BIOPLANET** is fully flexible homogeneous compacted floorcovering in sheet, 2 m wide, providing excellent resistance to wear and tear in high traffic areas. Its weight is **2700 gr/m<sup>2</sup>**.

It features a non-directional design incorporating translucent chips that provides a 3D effect and ensures an even colour throughout the thickness presenting a nice matt finish over 40 colours. It contains over 75% sustainable of renewable raw materials. It includes a 100% bio based plasticizer, made of residues from non-agricultural food.

The flooring is equipped with **Evercare™**, patented surface treatment obtained by UV laser cross-linking offering the best chemical resistance to the main products used in healthcare environment as betadine, eosin, hydro alcoholic solutions, making the maintenance easy and the floor long lasting. This treatment avoids applying any acrylic emulsion throughout the lifetime of the product.

It is free of formaldehyde, heavy metals and CMR 1 & 2 or vPvB (very persistent and very bio-accumulative) or PBT (persistent, bio-accumulative and toxic) and is REACH compliant. It is **100% phthalates free and recyclable**. Its VOC emissions after 28 days (ISO 16000-6) are below detection levels (< 10 microgram/m<sup>3</sup> and g/m<sup>3</sup>) and this product is classified A+ (the best class). According to ISO 21702, Mipolam Bioplanet has **anti-viral activity** against Human Coronaviruses: it reduces the number of virus by 99.7% after 2h00. According to ISO 22196, Mipolam Bioplanet has **anti-bacterial activity** against E. coli, S. aureus and MRSA of 99% after 24h00.

The flooring is **antistatic** (< 2 kV), its residual indentation is ≈ 0.02 mm.

The flooring complies with the EN ISO 10581 norm, has a binder content Type I and is suitable for heavy duty traffic areas and **Bfl-s1 fire resistance**. As part of our sustainable development policy, this product is manufactured in the first floor covering plant awarded with the triple certification: ISO 9001 (quality), ISO 14 001 (environment) and OHSaS 18001 (safety).

# MIPOLAM PLANET & BIOPLANET New



Evercare™



100% recyclable

- ▶ **Recycled content 25%, 100% Recyclable**
- ▶ **Bio content 17% (Mipolam BioPlanet - on demand)**
- ▶ **Anti-viral activity & Anti-bacterial activity**  
Indoor air quality: TVOC 100 times below standard
- ▶ **40 COLOURS: Bright and subtle non directional design**
- ▶ **Heavy traffic resistance**
- ▶ **Ease of maintenance thanks to Evercare™**

			MIPOLAM PLANET	MIPOLAM BIOPLANET	MIPOLAM PLANET R10
<b>DESCRIPTION</b>					
Total thickness	EN ISO 24346	mm	2	2	2
Weight	EN ISO 23997	g/sqm	2700	2700	2700
Width of sheet	EN ISO 24341	cm	200	200	200
Tile size	EN ISO 24342	mm	608 x 608 <sup>(1)</sup>	608 x 608 <sup>(1)</sup>	608 x 608 <sup>(1)</sup>
Length of sheet	EN ISO 24341	lm	20	20	20
<b>CLASSIFICATION</b>					
Norm / Product specification	-	-	EN ISO 10581	EN ISO 10581	EN ISO 10581
European classification	EN ISO 10874	class	34-43	34-43	34-43
Fire rating	EN 13501-1	class	Bfl-s1	Bfl-s1	Bfl-s1
Static electrical propensity	EN 1815	kV	< 2	< 2	< 2
Slip resistance	DIN 51130	class	R9	R9	R10
<b>PERFORMANCES</b>					
Type Binder content	EN ISO 10581	type	I	I	I
Dimensional stability	EN ISO 23999	%	sheet < 0.40	sheet < 0.40	sheet < 0.40
Dimensional stability (average measured value)	-	%	sheet ≈ 0.10	sheet ≈ 0.10	sheet ≈ 0.10
Impact Sound Insulation	EN ISO 717-2	dB	5	5	5
Residual indentation (norm)	EN ISO 24343-1	mm	≤ 0.10	≤ 0.10	≤ 0.10
Residual indentation (average measured value)	-	mm	≈ 0.02	≈ 0.02	≈ 0.02
Castor chair test (type H)	ISO 4918	-	OK	OK	OK
Decontamination	ISO 8690		Excellent	Excellent	Excellent
Watertightness	EN 13553	Annex A	Pass	Pass	Pass
Thermal conductivity	EN ISO 10456	W/(m.k)	0.25	0.25	0.25
Colour fastness	EN 20 105 - B02	degree	≥ 7	≥ 7	≥ 7
Surface treatment	-	-	Evercare™	Evercare™	Evercare™
Chemical products resistance	EN ISO 26987	class	OK	OK	OK
Anti-bacterial activity (E. coli - S. aureus - MRSA) after 24h <sup>(2)</sup>	ISO 22196	-	> 99% inhibits growth	> 99% inhibits growth	> 99% inhibits growth
Anti-viral activity (human coronavirus) after 2h <sup>(2)</sup>	ISO 21702	-	> 99.7% virucidal activity	> 99.7% virucidal activity	> 99.7% virucidal activity
<b>ENVIRONMENT / INDOOR AIR QUALITY</b>					
TVOC after 28 days	ISO 16000-6	microgram/m <sup>3</sup>	< 10	< 10	< 10
Certification	-	-	Floorscore®	Floorscore®	Floorscore®
<b>CE MARKING</b>					
<b>CE</b>	EN 14041				

(1) Products available in tiles for a minimum quantity order of 500 sqm.

(2) The implementation of an effective cleaning regime is the most important defence against infection.

# MIPOLAM HOMOGENEOUS

## MIPOLAM PLANET & BIOPLANET **New**



Evercare™



5404 Vanilla Sky



^ Scale 1



5403 Moon Dust



5402 Ivory Dust



5412 Moon Stone



5424 Hawk Eye



5439 Moon Way



5441 Clay Soil



5432 Sun Stone



5418 Terra Nera



5422 Sunflower



5438 Andalusite

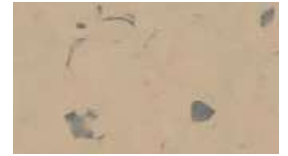

5428 Shedded Ground



5443 Wood Path



5445 Tree Bark



5444 Rocky Hill



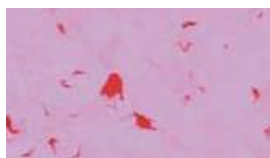

5482 Sugar Drip



5406 Moqui



5430 Sideral Grey



5460 Lava Stone



5437 Reef Water



5416 Acquamarina



5450 Blended Ashes



5459 Stormy Cloud

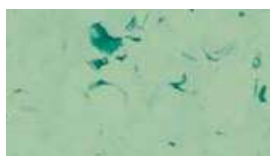

5417 Foggy Hill



5426 Shadow



5420 Stone Powder



5429 Fog Patch



5427 Green Zest



5436 Tiger Eye



5413 Rain Fall



5439 Moon Way



5447 Aventurine



5456 Intense Indigo



5410 Silex



5411 Atlantic Grey



5455 Lava Flow



5466 Rocky Blue



5408 Chalk Dust



5409 Pebble Beach



5475 Intense Ruby



5446 Blue Nug





# MIPOLAM HOMOGENEOUS

## MIPOLAM ELEGANCE / AFFINITY / ACCORD / COSMO / TROPLAN

### ▶ MIPOLAM ELEGANCE

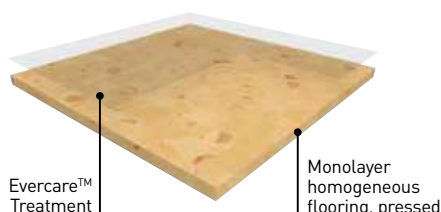

**MIPOLAM ELEGANCE** is a monolayer homogeneous flooring with a high PVC content pressed in 2 m sheets, with a thickness of 2 mm and a **weight of ≤ 2850 g**. The non directional design with colour throughout the thickness integrates a 3D effect (transparent particles in pure PVC on all 33 references) and a **mat finish**.

This flooring is recommended for administrative buildings making skirtings easier, as well as angles and welding. The flooring is equipped with **Evercare™** the latest improvements in polyurethane surface treatment obtained by **UV laser cross-linking**. This Evercare™ treatment avoids staining of **chemical products used in Healthcare** like betadine, eosin or anti-bacterial hand gel and increases the durability of the flooring. This treatment has excellent maintenance characteristics and does not require the application of acrylic polishes.

According to ISO 21702, **MIPOLAM ELEGANCE** has **anti-viral activity** against Human Coronaviruses: it reduces the number of virus by 99.7% after 2h. According to ISO 22196, **MIPOLAM ELEGANCE** has **anti-bacterial activity** against E. coli, S. aureus and MRSA of 99% after 24h. The flooring is composed of minimum **25% recycled content 100% controlled** and is **REACH compliant**. It is 100% recyclable and 100% phthalate free. This flooring is **antistatic** (< 2 kV), compliant to EN ISO 10581 with a binder content type I, is suitable for heavy duty traffic areas and has a **Bfl-s1 fire** resistance. The product is non reactive to residual indentation with a value ≤ 0.02 mm. The product emission rate of volatile organic compounds is <10 microgram/m<sup>3</sup> (TVOC after 28 days ISO 16000-6).

### ▶ MIPOLAM AFFINITY

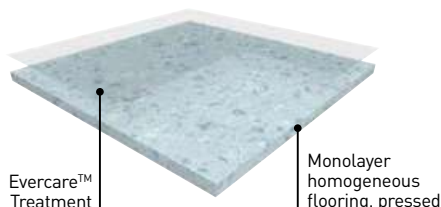

**MIPOLAM AFFINITY** is a vinyl flooring homogeneous pressed in 2 m sheets, with a thickness of 2 mm and a **weight of 2800 g**. The non-directional design with colour throughout the thickness is available in 50 references presenting a contrasted designed & a **mat finish**. This flooring is recommended for collective buildings making skirtings easier, as well as angles and welding. The flooring is equipped with **Evercare™**, patented surface treatment obtained by **UV laser cross-linking** offering **the best chemical resistance to the main products used in healthcare** environment as betadine, eosin, hydro alcoholic solutions, making the maintenance easy and the floor long lasting. This treatment **avoids applying any acrylic emulsion** throughout the lifetime of the product.

According to ISO 21702, **MIPOLAM AFFINITY** has **anti-viral activity** against Human Coronaviruses: it reduces the number of virus by 99.7% after 2h. According to ISO 22196, **MIPOLAM AFFINITY** has **anti-bacterial activity** against E. coli, S. aureus and MRSA of 99% after 24h. It is free of formaldehyde, heavy metals and CMR 1 & 2 or vPvB (very persistent and very bio-accumulative) or PBT (persistent, bio-accumulative and toxic) and is **REACH compliant**. It is 100% phthalate free and recyclable. Its VOC emissions after 28 days (ISO 16000-6) are below detection levels (<10 microgram/m<sup>3</sup>) and this product is classified A+ (the best class). This flooring is **antistatic** (< 2 kV), its residual indentation is ≤ 0.02 mm to 150 minutes respecting EN ISO 24343-1. This flooring complies with EN ISO 10581 offering a Binder content Type I, which makes it suitable for heavy duty traffic areas. It has a **Bfl-s1 fire** resistance.

### ▶ MIPOLAM ACCORD

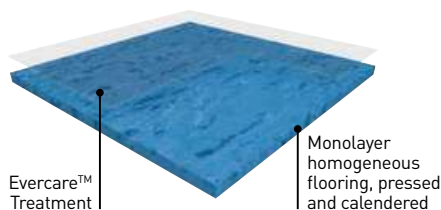

**MIPOLAM ACCORD** is a monolayer homogeneous flooring with high PVC content calendered and pressed in 2 m sheets, with a thickness of 2 mm and a **weight of ≤ 2790 g**. The semi-directional design with colour throughout the thickness is available in 28 references presenting a nice **mat finish**.

This flooring is recommended for collective buildings making skirtings easier, as well as angles and welding. The flooring is equipped with **Evercare™** the latest improvements in polyurethane surface treatment obtained by **UV laser cross-linking**. This Evercare™ **avoids staining of chemical products used in Healthcare** like betadine, eosin or anti-bacterial hand gel and increases the durability of the flooring. This treatment has excellent maintenance characteristics and does not require the application of acrylic polishes.

According to ISO 21702, **MIPOLAM ACCORD** has **anti-viral activity** against Human Coronaviruses: it reduces the number of virus by 99.7% after 2h. According to ISO 22196, **MIPOLAM ACCORD** has **anti-bacterial activity** against E. coli, S. aureus and MRSA of 99% after 24h. The flooring is composed of minimum **25% recycled content 100% controlled** and is **REACH compliant**. It is 100% phthalate free and 100% recyclable. This flooring is **antistatic** (< 2 kV). The product is non-reactive to residual indentation with a value ≤ 0.02 mm to 150 minutes respecting EN ISO 24343-1. The flooring is compliant with EN ISO 10581 norm, has a binder content type I, is suitable for heavy duty traffic areas and has a **Bfl-s1 fire** resistance. The product emission rate of volatile organic compounds is < 10 microgram/m<sup>3</sup> (TVOC after 28 days ISO 16000-6).

## MIPOLAM ELEGANCE / AFFINITY / ACCORD / COSMO / TROPLAN

## ▶ MIPOLAM COSMO



**MIPOLAM COSMO** is a vinyl flooring homogeneous calendered and pressed in 2 m sheets, with a thickness of 2 mm and a **weight ≤ 3000 g**. The semi-directional design with colour throughout the thickness is available in 10 references presenting a nice **matt finish**.

This flooring is suitable for medium to high traffic areas, and facilitates floor-wall junctions, angles and welding treatments. The flooring is equipped with **Evercare™**, patented surface treatment obtained by UV laser cross-linking offering **the best chemical resistance to the main products used in healthcare** environment as Betadine, eosin, hydro alcoholic solutions, making the maintenance easy and long lasting the flooring. This treatment avoids applying any acrylic emulsion throughout the lifetime of the product.

According to ISO 21702, **MIPOLAM COSMO** has **anti-viral activity** against Human Coronaviruses: it reduces the number of virus by 99.7% after 2h. According to ISO 22196, **MIPOLAM COSMO** has **anti-bacterial activity** against E. coli, S. aureus and MRSA of 99% after 24h. It is composed of 45% minerals, 22% of inexhaustible material and at least **25% of recycled 100% controlled**. It is free of formaldehyde, heavy metals and CMR 1 & 2 or vPvB (very persistent and very bio-accumulative) or PBT (persistent, bio-accumulative and toxic) and is **REACH compliant**. It is 100% phthalate free and 100% recyclable. VOC emissions after 28 days (ISO 16000-6) are below detection levels with <10 microgram/m<sup>3</sup> and this product is classified A + (the best class). The flooring is **antistatic** (< 2 kV), its residual indentation is ≤ 0.02 mm. The flooring is compliant with EN ISO 10581 norm, has a binder content type I, is suitable for heavy duty traffic areas and has a **Bfl-s1 fire** resistance.

## ▶ MIPOLAM TROPLAN

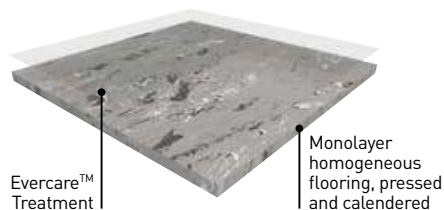

**MIPOLAM TROPLAN** is a vinyl flooring homogeneous calendered and pressed in 2 m sheets, with a thickness of 2 mm and a **weight ≤ 3300 g**. The directional design with colour throughout the thickness is available in 18 references presenting a nice **matt finish**.

This flooring is suitable for medium to high traffic areas, and facilitates floor-wall junctions, angles and welding treatments. The flooring is equipped with **Evercare™**, patented surface treatment obtained by **UV laser cross-linking** offering **the best chemical resistance to the main products used in healthcare** environment as Betadine, eosin, hydro alcoholic solutions, making the maintenance easy and long lasting the flooring. This treatment **avoids applying any acrylic emulsion** throughout the lifetime of the product.

According to ISO 21702, **MIPOLAM TROPLAN** has **anti-viral activity** against Human Coronaviruses: it reduces the number of virus by 99.7% after 2h. According to ISO 22196, **MIPOLAM TROPLAN** has **anti-bacterial activity** against E. coli, S. aureus and MRSA of 99% after 24h. It is composed of 45% minerals, 22% of inexhaustible material and at least **25% of recycled 100% controlled**. It is free of formaldehyde, heavy metals and CMR 1 & 2 or vPvB (very persistent and very bio-accumulative) or PBT (persistent, bio-accumulative and toxic) and is **REACH compliant**. Mipolam Troplan is 100% phthalate free and 100% recyclable. VOC emissions after 28 days (ISO 16000-6) are below detection levels with < 10 microgram/m<sup>3</sup> and this product is classified A + (the best class). The flooring is **antistatic** (< 2 kV), its residual indentation is ≤ 0.03 mm. The flooring is compliant to the EN ISO 10581 norm, has a binder content type II, is suitable for heavy duty traffic areas and has a **Bfl-s1 fire** resistance.



# MIPOLAM HOMOGENEOUS

## MIPOLAM ELEGANCE / AFFINITY / ACCORD / COSMO / TROPLAN



Evercare™



100% recyclable

### High performing homogeneous multipurpose floorings

#### Suitable for heavy traffic areas (education, healthcare, shops)

- ▶ Mipolam Mipolam Elegance / Mipolam Affinity / Mipolam Accord / Mipolam Cosmo / Mipolam Troplan: Evercare™ - New revolutionary patented polyurethane surface treatment with unique performance in staining providing unrivalled chemical and scratching resistance
- ▶ Antistatic
- ▶ Densely compacted surface for improved wear and ease of maintenance.

			MIPOLAM ELEGANCE	MIPOLAM AFFINITY	MIPOLAM ACCORD	MIPOLAM COSMO	MIPOLAM TROPLAN
<b>DESCRIPTION</b>							
Total thickness	EN ISO 24346	mm	2	2	2	2	2
Weight	EN ISO 23997	g/sqm	2850	2800	2790	3000	3300
Width of sheet	EN ISO 24341	cm	200	200	200	200	200
Length of sheet	EN ISO 24341	lm	20	20	20	20	20
Tile size	EN ISO 24342	mm	608 x 608 <sup>(1)</sup>	608 x 608 <sup>(1)</sup>	608 x 608 <sup>(1)</sup>	608 x 608 <sup>(1)</sup>	608 x 608 <sup>(1)</sup>
Number of tiles per package	-	-	20	20	20	20	20
<b>CLASSIFICATION</b>							
Norm / Product specification	-	-	EN ISO 10581	EN ISO 10581	EN ISO 10581	EN ISO 10581	EN ISO 10581
European classification	EN ISO 10874	class	34-43	34-43	34-43	34-43	34-43
Fire rating	EN 13501-1	class	B <sub>fl</sub> -s1	B <sub>fl</sub> -s1	B <sub>fl</sub> -s1	B <sub>fl</sub> -s1	B <sub>fl</sub> -s1
Static electrical propensity	EN 1815	kV	< 2	< 2	< 2	< 2	< 2
Slip resistance	DIN 51130	class	R9	R9	R9	R9	R9
<b>PERFORMANCES</b>							
Type Binder content	EN ISO 10581	type	I	I	I	I	II
Dimensional stability (requirement)	EN ISO 23999	%	Sheet ≤ 0.40 Tile ≤ 0.25	Sheet ≤ 0.40 Tile ≤ 0.25	Sheet ≤ 0.40 Tile ≤ 0.25	Sheet ≤ 0.40 Tile ≤ 0.25	Sheet ≤ 0.40 Tile ≤ 0.25
Dimensional stability (average measured value)	EN ISO 23999	%	-	-	-	-	-
Impact Sound Insulation	EN ISO 717-2	dB	5	5	5	5	4
Residual indentation (norm)	EN ISO 24343-1	mm	≤ 0.10	≤ 0.10	≤ 0.10	≤ 0.10	≤ 0.10
Residual indentation (average measured value)	-	mm	≈ 0.02	≈ 0.02	≈ 0.02	≈ 0.02	≈ 0.03
Castor chair test (type H)	ISO 4918	-	OK	OK	OK	OK	OK
Thermal conductivity	EN ISO 10456	W/(m.k)	0.25	0.25	0.25	0.25	0.25
Colour fastness	EN 20 105 - B02	degree	≥ 6	≥ 6	≥ 6	≥ 6	≥ 6
Surface treatment	-	-	Evercare™	Evercare™	Evercare™	Evercare™	Evercare™
Chemical products resistance	EN ISO 26987	class	OK	OK	OK	OK	OK
Anti-bacterial activity (E. coli - S. aureus - MRSA) after 24h <sup>(2)</sup>	ISO 22196	-	> 99% inhibits growth	> 99% inhibits growth	> 99% inhibits growth	> 99% inhibits growth	> 99% inhibits growth
Anti-viral activity (human coronavirus) after 2h <sup>(2)</sup>	ISO 21702	-	> 99.7% virucidal activity	> 99.7% virucidal activity	> 99.7% virucidal activity	> 99.7% virucidal activity	> 99.7% virucidal activity
<b>ENVIRONMENT / INDOOR AIR QUALITY</b>							
TVOC after 28 days	ISO 16000-6	microgram/m <sup>3</sup>	< 10	< 10	< 10	< 10	< 10
Certification	-	-	Floorscore®	Floorscore®	Floorscore®	Floorscore®	Floorscore®
<b>CE MARKING</b>							
	EN 14041						

(1) Products available in tiles for a minimum quantity order of 500 sqm.

(2) The implementation of an effective cleaning regime is the most important defence against infection.



# MIPOLAM HOMOGENEOUS

## MIPOLAM ELEGANCE



Evercare™



0329 Hazelnut

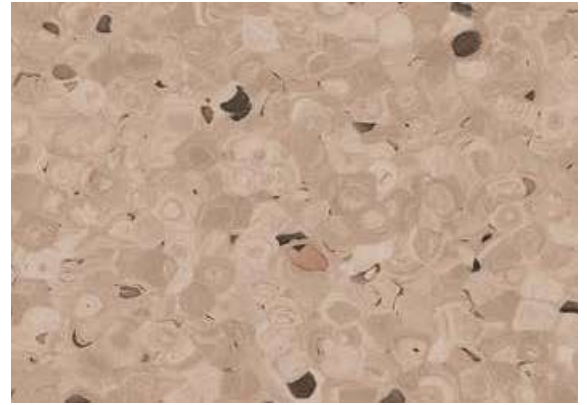

0329 Hazelnut

^ Scale 1



0705 Patisson



0347 Mangoustan



0696 Ginger



0318 Grape



0343 Pecan



0344 Nutmeg



0697 Greenstone



0321 Olive







0322 Jicama



0699 Banana



0340 Jambolan



0704 Raspberry Grey



0328 Almond



0333 Ananas



0339 Apple



0319 Quetsche



0323 Nut



0700 Melon



0338 Kiwi

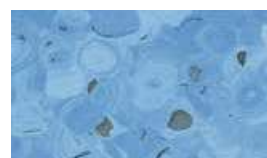

0348 Bluetta



0324 Chestnut



0327 Pear



0703 Lime



0341 Bilberry



0698 Cacao



0702 Kumquat



0330 Litchi

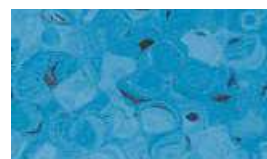

0342 Blueberry



0326 Jajoba



0331 Plum



0336 Acerola



0349 Bluecrop



◆ Tiles (608 x 608 mm) available for a minimum order quantity of 500 sqm.

◆ References also available as Elegance SD suitable for Shower system.

# MIPOLAM HOMOGENEOUS

## MIPOLAM AFFINITY

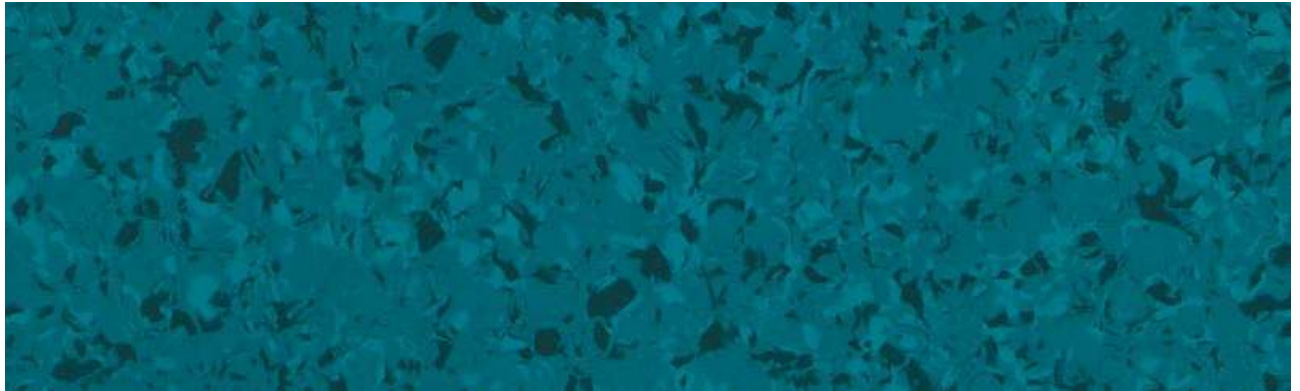

4476 Amethyst



^ Scale 1

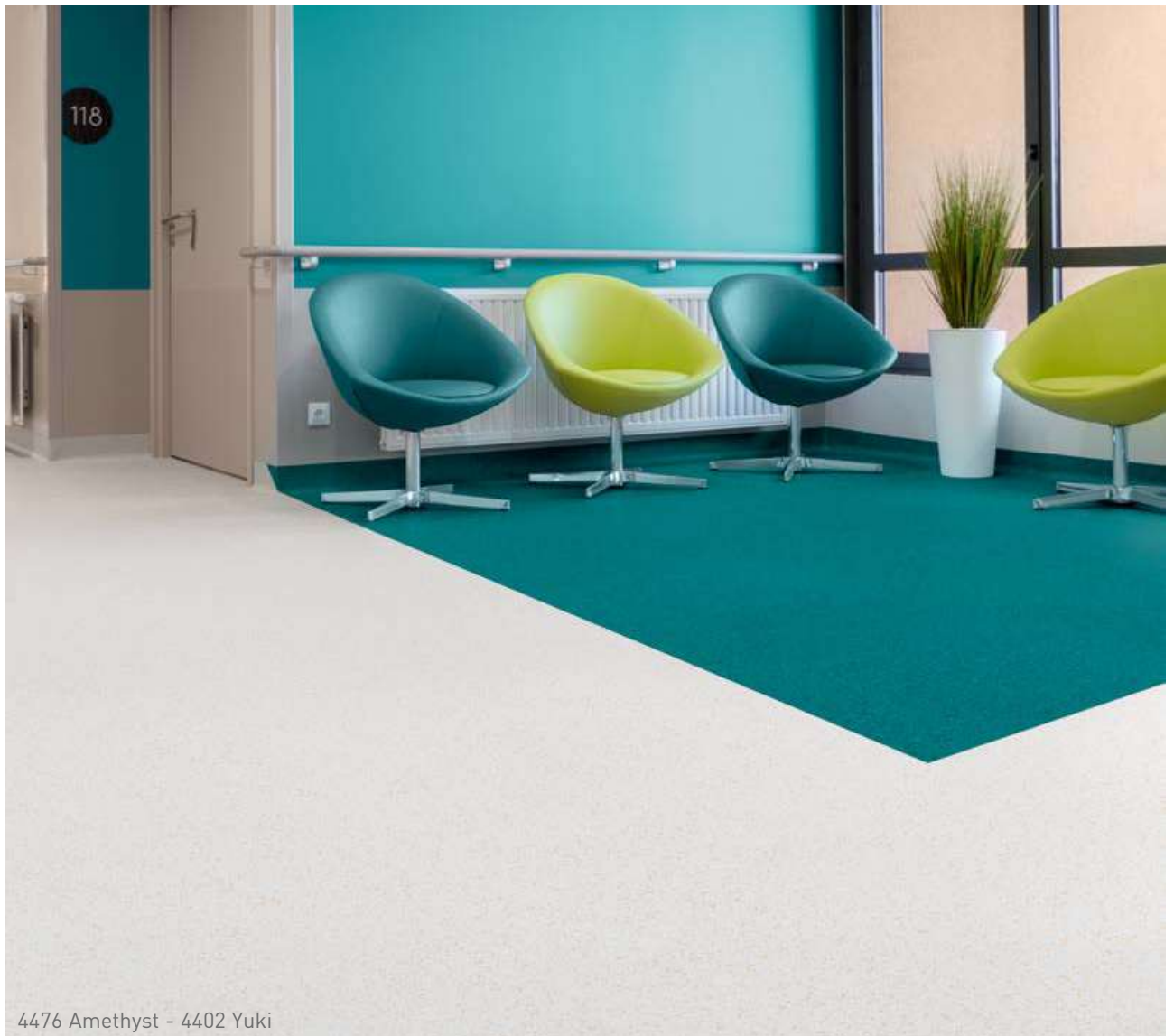

4476 Amethyst - 4402 Yuki

◆ Tiles (608 x 608 mm) available for a minimum order quantity of 500 sqm.

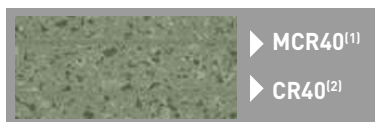

4417 Aquamarine

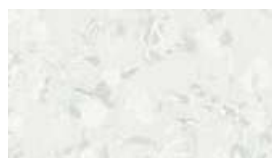

4408 Crystal Ice



4482 Orchid



4448 Ruby



4496 Light Sapphire



4409 Matte Grey



4481 Rosaspina



4475 Cinabre



4416 Sapphire



4410 Violet Grey



4437 Cashmere Rose



4455 Orange Sunlight



4446 Blue Ocean

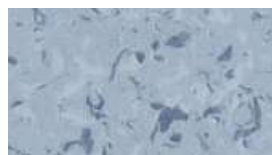

4426 Baltic



4429 Gray Opal



4435 Butternut



4436 Santorini



4420 Silver Grey



4430 Pearl Grey



4425 Amber



4466 Thistle



4450 Stormy Weather



4434 Cast Iron



4460 Black Stone



4459 Grey Storm



4433 Ash Coat



(1) Mentioned colors available with MCR40 specific multicolor welding rod (code: H058)  
(2) All colors available with CR40 matching uni welding rod (code: 05851)



# MIPOLAM HOMOGENEOUS

## MIPOLAM AFFINITY



- Compact
- Compact
- Evercare™
- 100% recyclable



4402 Yuki



^ Scale 1

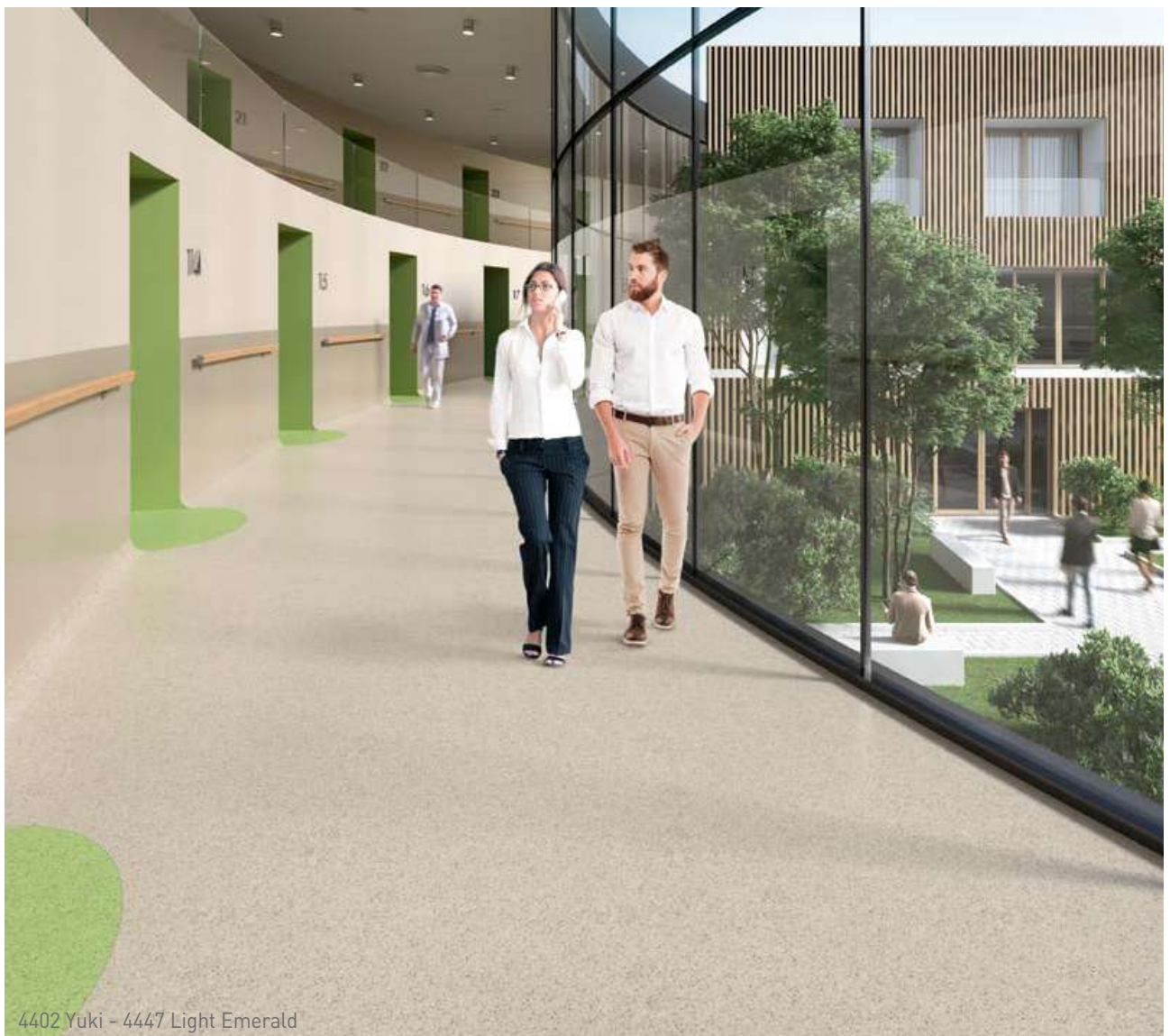

4402 Yuki - 4447 Light Emerald

◆ Tiles (608 x 608 mm) available for a minimum order quantity of 500 sqm.



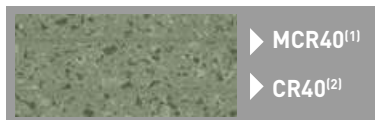

4445 Mocca



4443 Lime Taupe



4444 Havana Brown



4467 Clover



4431 Exotic Mud



4463 Greige



4428 Sandy



4457 Olivine



4413 Marlyn



4441 Light Greige



4404 Milkshake



4427 Pine Forest



4412 Tundra



4405 Sand Opal



4424 Smoked Opal



4407 Spearmint

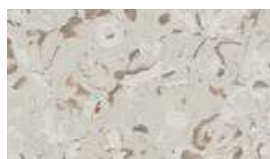

4411 Raffia



4401 Quartz

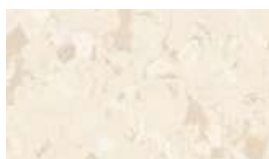

4403 Natural Shade



4477 Light Emerald



4432 Citrine



4422 Mango



(1) Mentioned colors available with MCR40 specific multicolor welding rod (code: H058)  
(2) All colors available with CR40 matching uni welding rod (code: 05851)

# MIPOLAM HOMOGENEOUS

## MIPOLAM ACCORD



 Compact |  Compact | Evercare™ |  100% recyclable

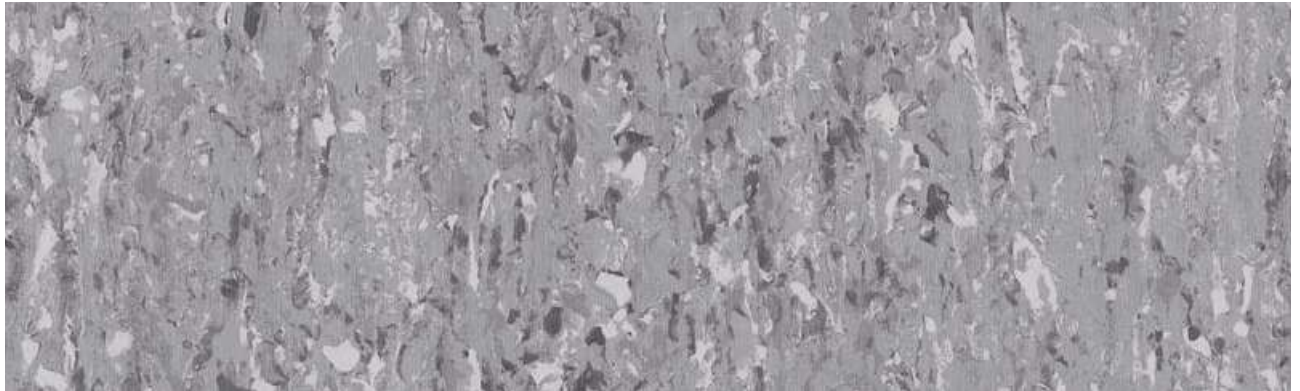

0330 Kruger



^ Scale 1



0330 Kruger / 0321 Salt

◆ Tiles (608 x 608 mm) available for a minimum order quantity of 500 sqm.

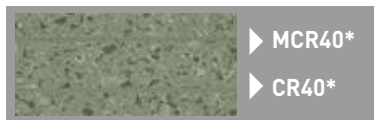

0321 Salt



0332 Dore



0324 Sand



0312 Powell



0447 Grunsee



0425 Cork

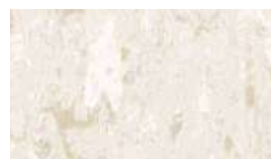

0301 Louise



0310 Huron



0457 Como



0315 Orange River



0303 Manitoba



0319 Toba



0417 Constance



0448 Bandak



0305 Light Sand



0320 Ontario



0306 Inari



0437 Flamingo Resort



0441 Loch Ness



0450 Thames



0316 Malaren



0463 Bourget



0443 Krumme



0360 Balaton



0346 Roxen



0445 Otto



0459 Mississippi



\* All colors available with MCR40 specific multicolor welding rod (code: H058) and with CR40 matching uni welding rod (code: 05851)



# MIPOLAM HOMOGENEOUS

## MIPOLAM COSMO



- Compact
- Compact
- Evercare™
- 100% recyclable



2633 Lichen

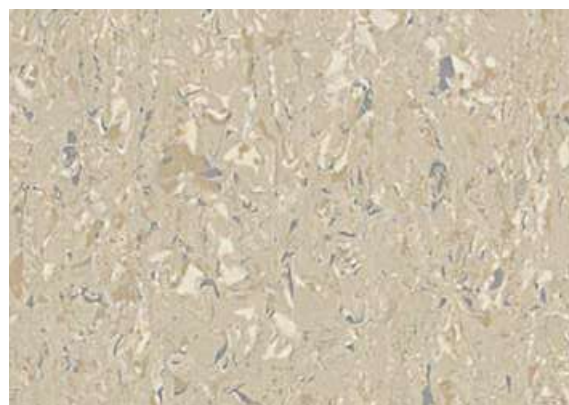

2633 Lichen

^ Scale 1



2603 Lemon Chiffon



2317 Soft Green



2609 Light Smoke



2606 Azur



2610 Silver

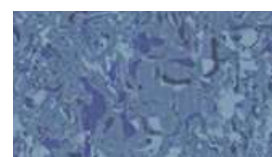

2636 Overseas



2638 Pure Grey



2355 Real Red



2639 Smart Grey



◆ Tiles (608 x 608 mm) available for a minimum order quantity of 500 sqm.

# MIPOLAM TROPLAN



Evercare™



1004 Earth



1004 Earth

^ Scale 1



1009 Light Grey



1032 Yellow



1055 Apricot



1002 Beige



1010 Grey



1006 Blue



1007 Green



1003 Light Ocre



1059 Blue Grey



1036 Medium Blue



1037 Medium Green



1035 Ocre



1040 Dark Grey



1056 Dark Blue



1057 Dark Green



1033 Brown



1060 Anthracite



# MIPOLAM HOMOGENEOUS

## MIPOLAM CLASSIC

### ▶ MIPOLAM CLASSIC

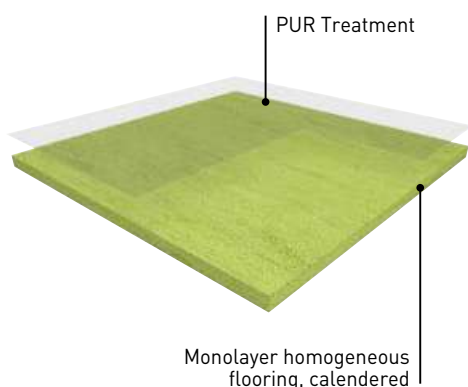

**MIPOLAM CLASSIC 1.5 mm** is a flexible homogeneous calendered compacted floorcovering in tiles or sheets, with directional design, colour dyed as a raw mixture to ensure even colour throughout the thickness of 1.5 mm and a **weight of ≤ 2520 g**. Its surface is densely compacted for improved wear and ease of maintenance. It receives a polyurethane (**PUR**) surface treatment for ease of maintenance and to avoid the use of an immediate acrylic emulsion after installation. The flooring complies with the **EN ISO 10874** (34-43) and EN ISO 10581, has a binder content type II, has Bfl-s1 fire resistance. It is suitable for heavy traffic areas. It is 100% recyclable. Its VOC emissions after 28 days (ISO 16000-6) are below detection levels (< 10 microgram/m<sup>3</sup>) and this product is classified A+ (the best class).

**MIPOLAM CLASSIC 2 mm** is a flexible homogeneous calendered compacted floorcovering in tiles or in 2 m sheets, with a thickness of 2 mm and a **weight of ≤ 3300 g**. This directional design, colour dyed as a raw mixture to ensure even colour throughout the thickness is available in 18 references. Its surface is densely compacted for improved wear and ease of maintenance. It receives a polyurethane (**PUR**) surface treatment for ease of maintenance and to avoid the use of an immediate acrylic emulsion after installation. The flooring complies with the **EN ISO 10874** (34-43) and EN ISO 10581, has a binder content type II, has Bfl-s1 fire resistance. It is suitable for heavy traffic areas. It is 100% recyclable. Its VOC emissions after 28 days (ISO 16000-6) are below detection levels (< 10 microgram/m<sup>3</sup>) and this product is classified A+ (the best class).

MIPOLAM CLASSIC				
DESCRIPTION				
Total thickness	EN ISO 24346	mm	1.5	2
Weight	EN ISO 23997	g/sqm	2520	3300
Width of sheet	EN ISO 24341	cm	200	200
Length of sheet	EN ISO 24341	lm	20	20
Tile size	EN ISO 24342	mm	-	300 x 300 <sup>(1)</sup> / 608 x 608
Number of tiles per package	-	-	-	50 / 20
CLASSIFICATION				
Norm / Product specification	-	-	EN ISO 10581	EN ISO 10581
European classification	EN ISO 10874	class	23-31	34-43
Fire rating	EN 13501-1	class	Bfl-s1	Bfl-s1
Static electrical propensity	EN 1815	kV	< 2	< 2
PERFORMANCES				
Type Binder content	EN ISO 10581	type	II	II
Dimensional stability	EN ISO 23999	%	≤ 0.40	Sheet ≤ 0.40 / Tile ≤ 0.25
Impact Sound Insulation	EN ISO 717-2	dB	-	4
Residual indentation (norm)	EN ISO 24343-1	mm	≤ 0.10	≤ 0.10
Residual indentation (average measured value)	-	mm	≈ 0.03	≈ 0.03
Castor chair test (type H)	ISO 4918	-	OK	OK
Thermal conductivity	EN ISO 10456	W/(m.k)	0.25	0.25
Colour fastness	EN 20 105 - B02	degree	≥ 6	≥ 6
Surface treatment	-	-	PUR	PUR
Chemical products resistance	EN ISO 26987	class	OK	OK
ENVIRONMENT / INDOOR AIR QUALITY				
TVOC after 28 days	ISO 16000-6	microgram/m <sup>3</sup>	< 10	
Certification	-	-	Floorscore®	
CE MARKING				
	EN 14041			

(1) Tiles (300 x 300 mm) available for a minimum order quantity of 500 sqm.





PUR



0002 Platinum



0002 Platinum



^ Scale 1



0301 Beige



0108 Pepper



0122 Pineapple



0123 Corallo



0003 Ivory



0005 Steel



0126 Nordica



0121 Green Leaf



0006 Honey



0303 Grey



0010 Azure



0120 Borneo



0014 Brown



0125 Truffle



0127 Bermuda



0013 Pewter



0124 Tortora



All colours available as 300 x 300mm tiles upon request for a minimum order quantity of 500 sqm

▲ Thickness: 1.5 mm - Sheet format only



PREMIUM

PAGES

**36/51**





**Premium** ..... **40**

- Poesy ..... 42
- Neopolis ..... 43
- Osmoz ..... 44
- Indiana ..... 46
- Metallica ..... 48
- Brazilia ..... 48

**My Premium** ..... **49**

**Premium Dry-Tex™** ..... **50**

**Attraction® Premium**  
(See page 190)



STILL UNIQUE  
**30** YEARS  
EXPERIENCE

# PREMIUM

THE UNRIVALLED HIGH TRAFFIC SOLUTION

## A SUSTAINABLE CHOICE



**100% recyclable**  
Recycled content 53%



**Adhesive free**  
for Attraction® tiles



**Health & Wellness**  
**Anti-viral** and **anti-bacterial** activity  
Acoustic: reduction **-17 dB** (Comfort)  
Indoor air quality: TVOC emissions  
10 times better than norms requirements



**Made in Europe**

**WE CARE | WE ACT.**

Our commitments for a sustainable future



## BEST TECHNOLOGIES IN ONE

---

### EVERCARE™ TECHNOLOGY



Stain resistance



Matt surface

---

### 100% PURE HOMOGENEOUS WEARLAYER



Superior abrasion & traffic resistance



Long lasting colors

---

### MULTILAYERED CONSTRUCTION



Exceptional dimensional stability



Acoustic properties

- 17 dB (Comfort sheet)
- 8 dB (Compact sheet)

---

*my* Premium

Customize  
your floor!



# PREMIUM

## ▶ PREMIUM COMFORT

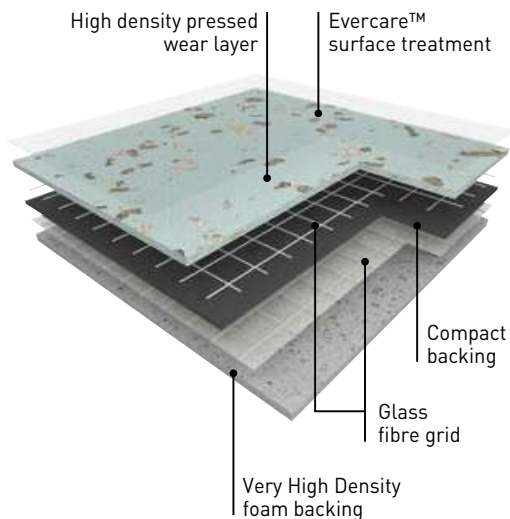

The floor covering is made of a  $\geq 1.02$  mm thick, pure vinyl homogeneous wear layer with no filler, incorporating very densely pressed coloured chips, with a mat finishing and without a transparent wear layer.

It offers a T group wear rating and is available in 2 m wide sheet.

The product contains a compact backing which is calendered, pressed and a Very High Density (VHD) foam backing. It is reinforced with a double glass fibre grid.

It offers a **17 dB (Metallica: 16 dB) sound insulation, an indentation resistance of 0.06 mm and a rolling heavy loads easiness.**

**PREMIUM COMFORT** is treated with **Evercare™**, a surface treatment obtained by UV laser crosslinking. It ensures easy maintenance and eliminates permanently the need for acrylic emulsion (metallisation). It avoids staining of chemical products used in healthcare like iodine alcohol, Betadine, eosin and anti-bacterial hand gel.

According to ISO 21702, **PREMIUM COMFORT** has **anti-viral activity** against Human Coronaviruses: it reduces the number of virus by 99.7% after 2h. According to ISO 22196, **PREMIUM COMFORT** has **anti-bacterial activity** against E. coli, S. aureus and MRSA of 99% after 24h.

It is 100% compliant with REACH.

It is composed of 40% of minerals and inexhaustible materials.

It is made with more than 50% recycled content; 100% of which are fully controlled and REACH compliant.

It does not contain any heavy metals, any formaldehydes.

It is made with phthalate free plasticizers.

The products emission rate of volatile organic compounds is **< 10 microgram/m<sup>3</sup> (TVOC after 28 days – ISO 16000-6).**

It is 100% recyclable.

## ▶ PREMIUM COMPACT

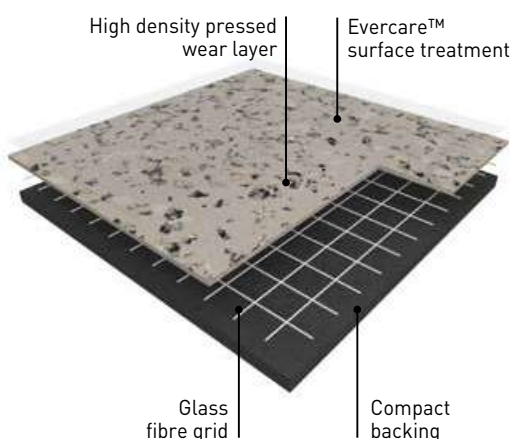

The floor covering is made of a  $\geq 1.02$  mm thick, pure vinyl homogeneous wear layer with no filler, incorporating very densely pressed coloured chips, with a mat finishing and without a transparent wear layer.

It offers a T group wear rating and is available in 2 m wide sheet.

Its compact backing is calendered, pressed and reinforced with a glass fibre grid yielding.

It offers a **8 dB sound insulation, an indentation resistance of 0.02 mm and a rolling heavy loads easiness.**

**PREMIUM COMPACT** is treated with **Evercare™**, a surface treatment obtained by UV laser crosslinking. It ensures easy maintenance and eliminates permanently the need for acrylic emulsion (metallisation). It avoids staining of chemical products used in healthcare like iodine alcohol, Betadine, eosin and anti-bacterial hand gel.

According to ISO 21702, **PREMIUM COMPACT** has **anti-viral activity** against Human Coronaviruses: it reduces the number of virus by 99.7% after 2h. According to ISO 22196, **PREMIUM COMPACT** has **anti-bacterial activity** against E. coli, S. aureus and MRSA of 99% after 24h.

It is 100% compliant with REACH.

It is composed of 40% of minerals and inexhaustible materials.

It is made with more than 50% recycled content; 100% of which are fully controlled and REACH compliant.

It does not contain any heavy metals, any formaldehydes.

It is made with phthalate free plasticizers.

The products emission rate of volatile organic compounds is **< 10 microgram/m<sup>3</sup> (TVOC after 28 days – ISO 16000-6).**

It is 100% recyclable.





17 dB

16 dB  
(Metallica)



Evercare™

100% recyclable

► **Outstanding durability**

Design within the whole thickness of the wear layer,  
≥ 1.02 mm thick

► **Long lasting appearance**

Pure vinyl wear layer (no filler, no transparent wear layer)  
for the best scratch and soiling resistance

► **Easy maintenance & matt effect**

Evercare™ surface treatment

► **Excellent indoor air quality**

TVOC after 28 days < 10 microgram/m<sup>3</sup>

► **Rolling heavy loads easiness, best stability and very**

**high performance indentation / acoustic 0.06 mm /  
17 dB (Metallica: 16 dB) for Comfort, 0.02 mm / 8 db for Compact**  
Glass fibre grid reinforcement & very high density foam backing

PREMIUM COMFORT

Poesy - Neopolis - Osmoz -  
Indiana - Metallica - Brazilia

PREMIUM COMPACT

Poesy - Neopolis - Osmoz -  
Indiana - Metallica - Brazilia

**DESCRIPTION**

			PREMIUM COMFORT	PREMIUM COMPACT
Total thickness	EN ISO 24346	mm	3.00 - 3.30	2.00
Thickness of wearlayer	EN ISO 24340	mm	≥ 1.02	≥ 1.02
Weight	EN ISO 23997	g/sqm	≥ 2800	≥ 2580
Width of sheet	EN ISO 24341	cm	200	200
Length of sheet	EN ISO 24341	lm	25	20

**CLASSIFICATION**

			PREMIUM COMFORT	PREMIUM COMPACT
Norm / Product specification	-	-	EN ISO 11638	EN ISO 10582
European classification	EN ISO 10874	class	34-42	34-43
Fire rating	EN 13501-1	class	Cfl-s1	Bfl-s1
Static electrical propensity	EN 1815	kV	< 2	< 2
Slip resistance	DIN 51 130	class	R10	R10

**PERFORMANCES**

			PREMIUM COMFORT	PREMIUM COMPACT
Wear resistance	EN 660.2	mm <sup>3</sup>	≤ 2.0	≤ 2.0
Wear group	-	group	T	T
Type Binder content	EN ISO 10582	type	-	I
Dimensional stability	EN ISO 23999	%	≤ 0.40	≤ 0.40
Residual indentation (requirement)	EN ISO 24343-1	mm	≤ 0.20	≤ 0.10
Residual indentation (average measured value)	-	mm	≈ 0.06	≈ 0.02
Impact sound insulation	EN ISO 717-2	dB	17 16 (Metallica)	8
Castor chair test (type H)	ISO 4918	-	OK	OK
Thermal conductivity	EN ISO 10456	W/(m.k)	0.25	0.25
Colour fastness	EN 20 105 - B02	degree	≥ 6	≥ 6
Surface treatment	-	-	Evercare™	Evercare™
Chemical products resistance <sup>(1)</sup>	EN ISO 26987	-	OK	OK
Anti-bacterial activity (E. coli - S. aureus - MRSA) after 24h <sup>(2)</sup>	ISO 22196	-	> 99% inhibits growth	> 99% inhibits growth
Anti-viral activity (human coronavirus) after 2h <sup>(2)</sup>	ISO 21702	-	> 99.7% virucidal activity	> 99.7% virucidal activity

**ENVIRONMENT / INDOOR AIR QUALITY**

			PREMIUM COMFORT	PREMIUM COMPACT
TVOC after 28 days	ISO 16000-6	microgram/m <sup>3</sup>	< 10	< 10
Certification	-	-	Floorscore®	Floorscore®

**CE MARKING**



EN 14041



(1) Regarding the resistance to chemicals, please download the corresponding leaflet from our website.  
(2) The implementation of an effective cleaning regime is the most important defence against infection.

# PREMIUM

## POESY



- Compact
- Comfort
- 17 dB
- VHD
- Evercare™
- 100% recyclable

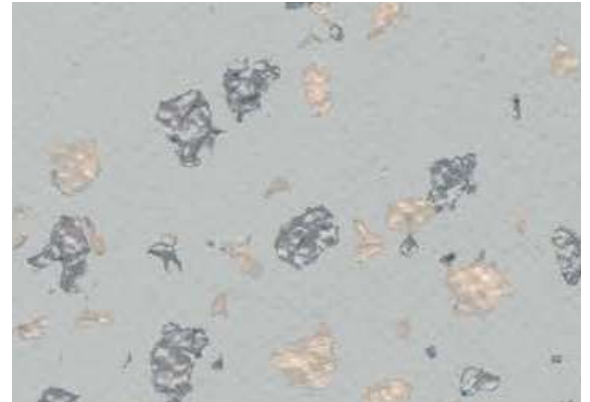

2750 Ellipse

^ Scale 1



7109 Idylle



2752 Litote



8626 Rime



2751 Slam



8627 Allegorie

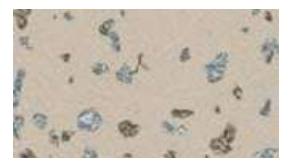

2747 Ballade



8621 Ode



2748 Refrain



2749 Lyrique



# NEOPOLIS



Premium



17 dB



Evercare™

100% recyclable



2744 Queens Soft

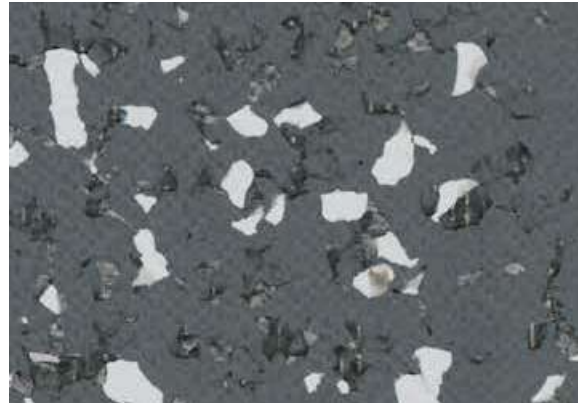

2741 Brooklyn

^ Scale 1



2743 Central Park



2745 Plaza



2744 Queens Soft



2740 Harlem Soft



2742 Times Square



Product available as Attraction® tiles - For more detail see page 190.



# PREMIUM

## OSMOZ

Compact | Comfort | 17 dB | VHD | Evercare™ | 100% recyclable



7735 Coffee Brown / 4350 Elefant

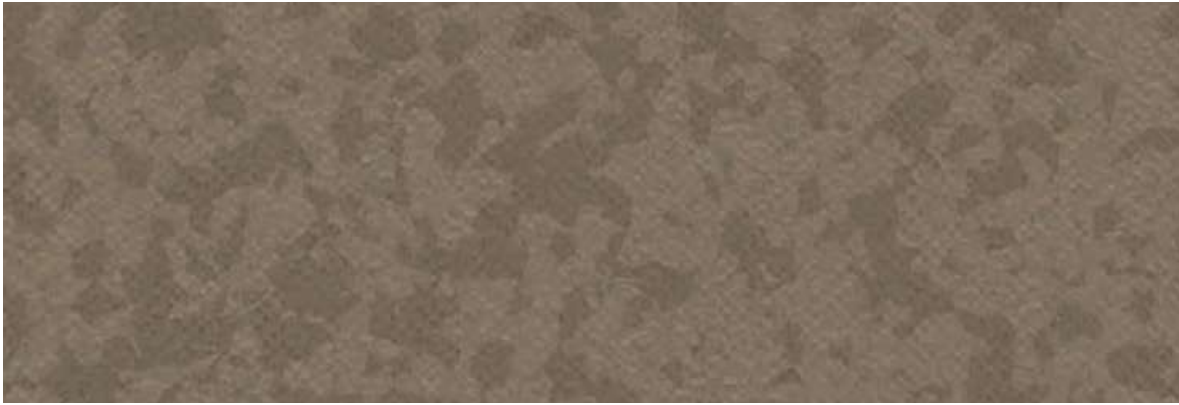

7735 Coffee Brown

^ Scale 1

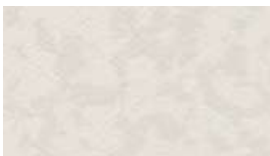

4364 Ivory New



4365 Alpaga New



3792 Storm Grey



3791 Slate Grey

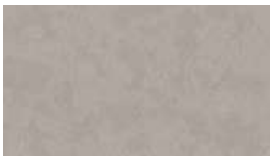

4350 Elefant



4349 Angora



4351 Greige

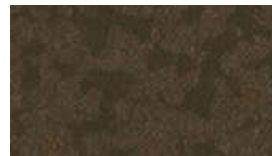

8073 Cocoa



4527 Bamboo



4496 Pacific Blue



0356 Denim



7737 Pepper Grey



7204 Mimosa



0702 Kumquat



7108 Grenadine



 Product available as Attraction® tiles - For more detail see page 190.

# PREMIUM

## INDIANA



- Compact
- Comfort
- 17 dB
- VHD
- Evercare™
- 100% recyclable



7517 Faroe



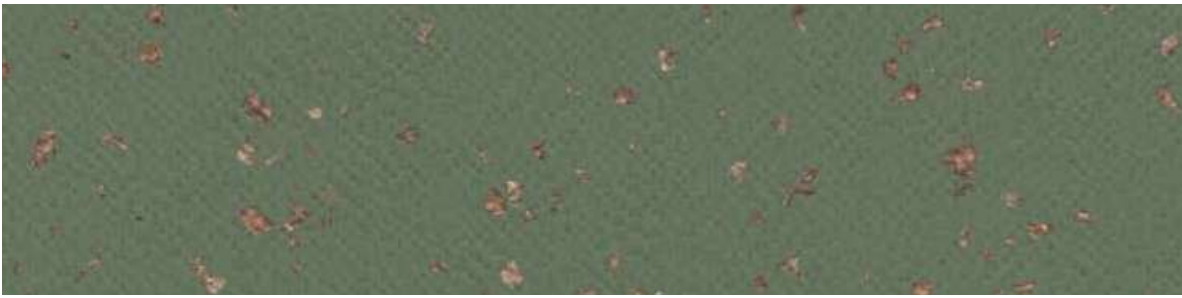

7517 Faroe

^ Scale 1



8059 Nicobar



8150 Bali



4343 Tokelau



8262 Rodrigues



8053 Anambas



8226 Fidji



3788 Nauru



4009 Tufoa



8470 Samoa



4003 Tao



4002 Manua



4001 Ofu



8837 Songo



4004 Pago



8850 Maupiti



4135 Aldabra



4015 Guinea



4526 Lasia



4469 Pemba



4476 Wattaru



8256 Tahaa



4142 Penang



4146 Moheli



8194 Kornati



 Product available as Attraction® tiles - For more detail see page 190.

 Product available as Premium & Gerflor Dry-Tex System.

# PREMIUM

## METALLICA / BRAZILIA



- Compact
- Comfort
- 16 dB**  
Metallica
- 17 dB**  
Brazilia
- VHD
- Evercare™**
- 100% recyclable

### METALLICA



8257 Nyx ^ Scale 1



9719 Eclipse

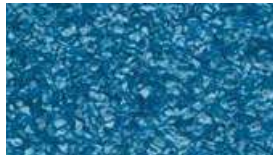

8625 Naiade



8623 Sedna

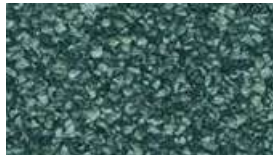

8624 Triton

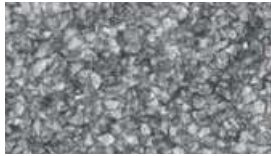

9745 Cosmic



9310 Tethys



9753 Energy



9330 Moon



2746 Ymir

### BRAZILIA



4342 Juara ^ Scale 1

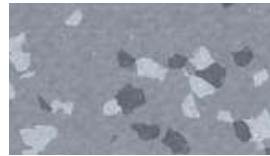

3709 Ceara



4478 Copacabana

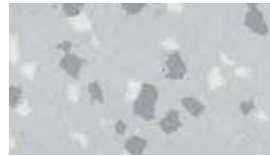

8736 Recife



4477 Maceio



3734 Almerim



8577 Amazonas



8386 Boa Vista



8269 Ipanema

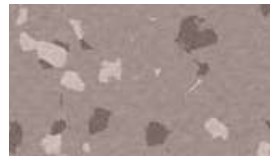

4329 Bacabal



8157 Golas



3707 Paraiba



4136 Sao Luis

CUSTOMIZE YOUR FLOOR!



**1 SELECT** A DESIGN TYPE

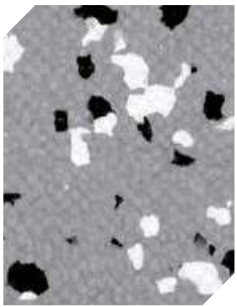

Brazilia

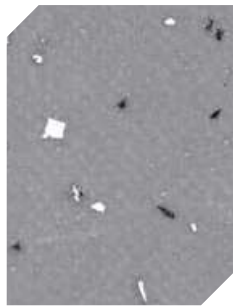

Indiana



Osmoz



Poesy

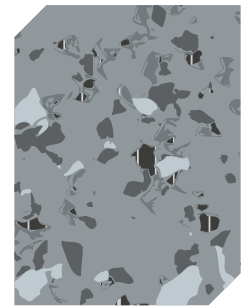

Neopolis

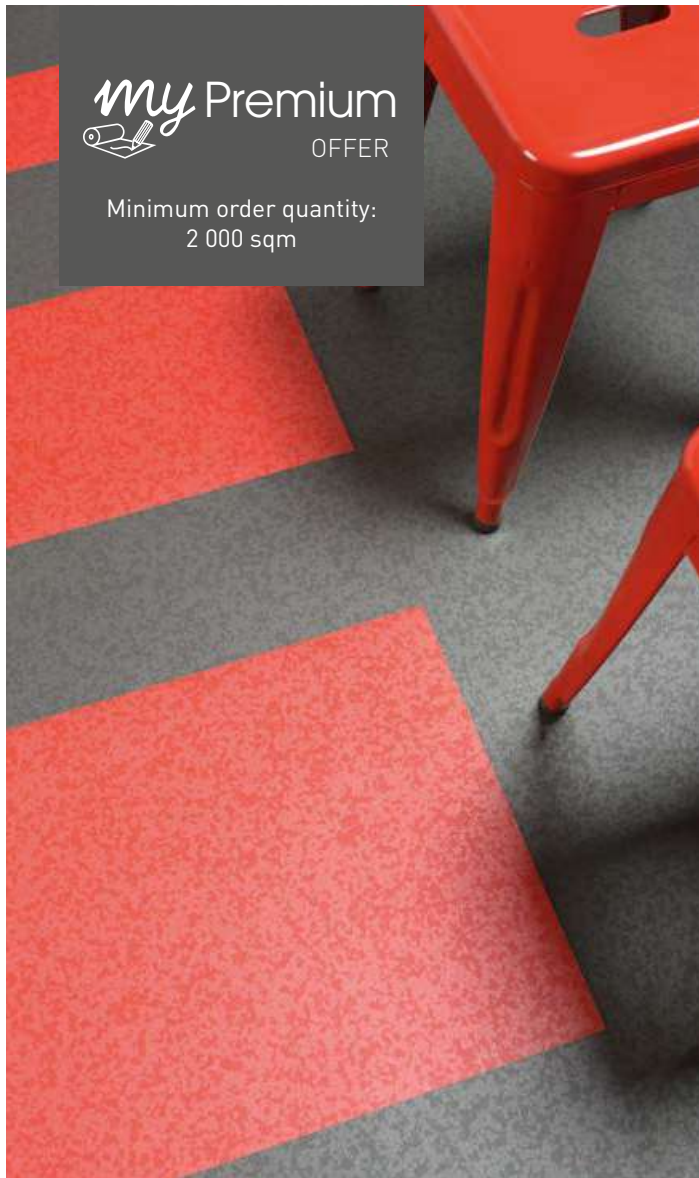

**2 CHOOSE** YOUR GRANULES: PALETTE

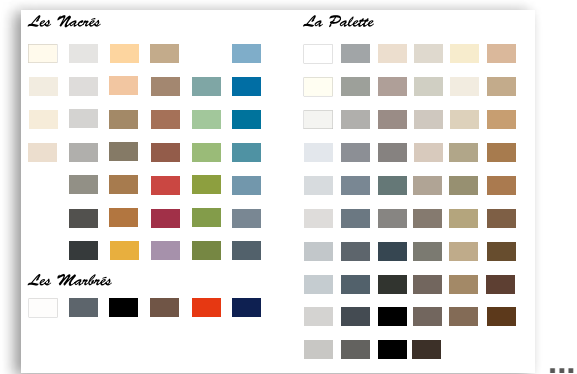

**3 VISUALIZE** YOUR DESIGN AND ORDER ONLINE ON



*my* Floor by Gerflor .com



# PREMIUM

## PREMIUM DRY-TEX™ SYSTEM

### THE SOLUTION FOR HIGH MOISTURE SUBFLOORS

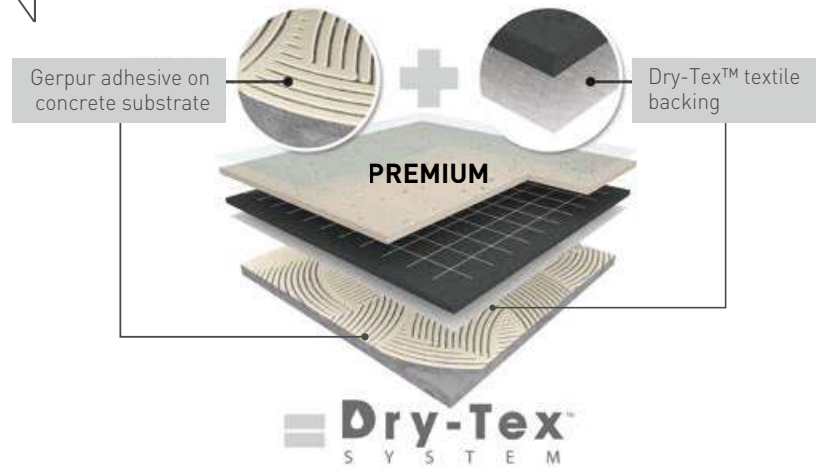

#### EMERGENCY DEPARTMENTS

- Reception areas
- Waiting rooms
- Corridors

#### HIGH MOISTURE SUBFLOORS

Proven resistance up to 98% RH / 15 lbs moisture according to ASTM F2170 & ASTM F1869

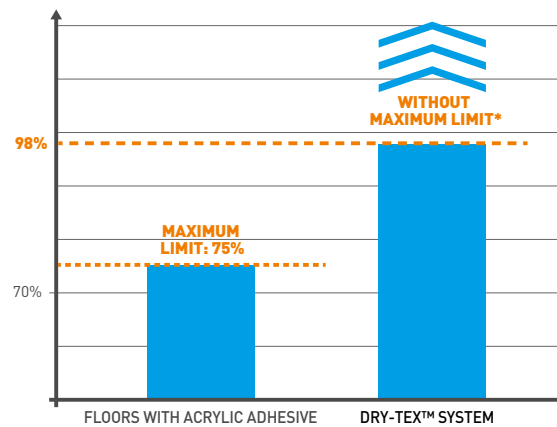

#### 4 REFERENCES AVAILABLE FROM STOCK



4343 Tokelau



8053 Anambas



4004 Pago



4003 Tao

All Premium Compact designs are available as Premium Dry-Tex™ for a minimum order quantity of 2400 sqm

# PREMIUM DRY-TEX™ SYSTEM



8 dB

Evercare™



## ▶ PREMIUM DRY-TEX™



**PREMIUM DRY-TEX™ SYSTEM** includes **PREMIUM DRY-TEX™** and **GERPUR glue**. This system provides a complete moisture mitigation in full-spread adhesive installation eliminating interposition barrier for any slab with high moisture (up to 98% RH).

**PREMIUM DRY-TEX™** is a multi-layered calendared and pressed vinyl floorcovering, with no filler and a group T wear rating, available in 2 m wide sheet. The product comprises a **1.02 mm thick homogeneous, pure vinyl wear layer incorporating very densely pressed coloured chips, with a mat finishing and without transparent wearlayer.**

The product comprises a 100% post-manufacturing compact reinforced with a glass fiber grid and a non-woven backing. The product offers 8 dB sound insulation, an indentation resistance of 0.06 mm and a rolling heavy loads easiness.

**PREMIUM DRY-TEX™** is treated with **Evercare™**, a surface treatment obtained by UV laser crosslinking. This Evercare™ ensures easy

maintenance and eliminates permanently the need for acrylic emulsion (metallisation). It avoids staining of chemical products used in healthcare like iodine alcohol, Betadine, eosin and anti-bacterial hand gel.

According to ISO 21702, **PREMIUM DRY-TEX™** has **anti-viral activity** against Human Coronaviruses: it reduces the number of virus by 99.7% after 2h.

According to ISO 22196, **PREMIUM DRY-TEX™** has **anti-bacterial activity** against E. coli, S. aureus and MRSA of 99% after 24h.

It is composed of 40% of minerals and inexhaustible materials. It is made of 100% controlled recycled materials. It does not contain any heavy metals or CMR 1&2 and they are 100% compliant with REACH. It is made with a phthalate free plasticizer. The products emission rate of volatile organic compounds is **< 10 microgram/m³ (TVOC after 28 days – ISO 16000-6).**

It is 100% recyclable.

			PREMIUM DRY-TEX™
<b>DESCRIPTION</b>			
Total thickness	EN ISO 24346	mm	2.50
Thickness of wearlayer	EN ISO 24340	mm	1.02
Weight	EN ISO 23997	g/sqm	2660
Width of sheet	EN ISO 24341	cm	200
Length of sheet	EN ISO 24341	lm	20
<b>CLASSIFICATION</b>			
Norm / Product specification	-	-	EN ISO 10582
European classification	EN ISO 10874	class	34-43
Fire rating	EN 13501-1	class	Bfl-s1
Static electrical propensity	EN 1815	kV	< 2
Slip resistance	DIN 51 130	class	R10
<b>PERFORMANCES</b>			
Wear resistance	EN 660.2	mm <sup>3</sup>	≤ 2.0
Wear group	-	group	T
Type Binder content	EN ISO 10582	type	I
Dimensional stability	EN ISO 23999	%	≤ 0.40
Residual indentation (requirement)	EN ISO 24343-1	mm	≤ 0.10
Residual indentation (value)	-	mm	≈ 0.03
Castor chair test (type H)	ISO 4918	-	OK
Thermal conductivity	EN ISO 10456	W/(m.k)	0.25
Impact sound insulation	EN ISO 717-2	dB	8
Colour fastness	EN 20 105 - B02	degree	≥ 6
Surface treatment	-	-	Evercare™
Chemical products resistance <sup>(1)</sup>	EN ISO 26987	-	OK
Anti-bacterial activity (E. coli - S. aureus - MRSA) after 24h <sup>(2)</sup>	ISO 22196	-	> 99% inhibits growth
Anti-viral activity (human coronavirus) after 2h <sup>(2)</sup>	ISO 21702	-	> 99.7% virucidal activity
<b>ENVIRONMENT / INDOOR AIR QUALITY</b>			
TVOC after 28 days	ISO 16000-6	microgram/m <sup>3</sup>	< 10
Certification	-	-	Floorscore®
<b>CE MARKING</b>			
	EN 14041		

(1) Regarding the resistance to chemicals, please download the corresponding leaflet from our website.

(2) The implementation of an effective cleaning regime is the most important defence against infection.



.....

TARALAY  
MULTILAYERED

..... PAGES .....

**52/99**

.....





**Taralay Libertex ..... 56**

- Reflect 60
- Amsterdam 61
- Paros 61
- Legend 62
- Cocoon 62
- Hossegor 62
- Skandi Oak 63
- Pure Oak 63

**Taralay Impression ..... 64**

- Corner 66
- Kubes 67
- Rice 68
- Stars 69
- Nest 69
- Uni Matt 70
- Leather 70
- Cemento 71
- Mohair 71
- Trame 72
- Gentlemen 72
- Wood 73-77

**Taralay Initial NEW ..... 78**

- Diversion 80
- Miami 81
- Spider 82
- Urban 83
- Strada 83
- Wood 84-87

**Timberline ..... 88**

- Wood 90-94
- Pixel 95

**Tarastep ..... 96**

# TARALAY MULTILAYERED

↑  
ABRASION RESISTANCE

Printed design - Transparent wearlayer



PUR +

Protcsol® Treatment

MAINTENANCE

**PREMIUM**

See pages 36/51



Taralay Impression  
Comfort Plus /  
Taralay Impression  
Compact Plus

Available on demand  
(minimum order quantity 800 sqm)

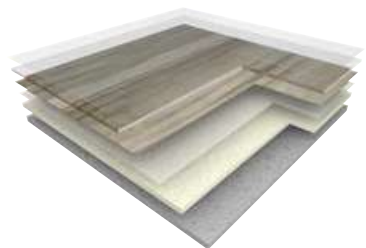

Taralay Impression  
Comfort

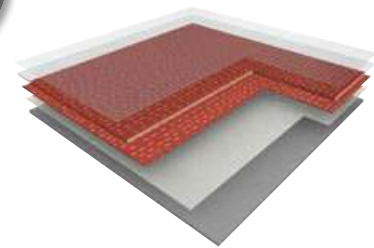

Taralay Impression  
Compact

Taralay  
Multilayered

Protecsol® Treatment



PROTECSOL® 2 Treatment





# TARALAY MULTILAYERED - FAST TRACK INSTALLATION

## TARALAY LIBERTEX

### ALL TARALAY BENEFITS ...

<b>HYGENIC &amp; EASY MAINTENANCE</b>	<b>HIGH TRAFFIC RESISTANCE</b>	<b>COMFORT</b>
	 34	 19 dB
PROTECSOL® SURFACE TREATMENT	0.7 mm WEARLAYER	MAX 3 LAYER SYSTEM

### ... WITH FAST TRACK INSTALLATION

<b>MINIMAL SUBFLOOR PREPARATION</b>	<b>NO SHUTDOWN</b>	<b>NO DRY TIME</b>
		
INSTALLATION ON EXISTING OR UNEVEN SUBFLOORS	NO ODOR, NO GLUE, MINIMUM FACILITY DOWNTIME	LOOSELAY SOLUTION



# TARALAY LIBERTEX

Taralay  
Multilayered



## FAST INSTALLATION IN ONE SOLUTION!



### ADHESIVE FREE

Apply double-sided tape (such as Fix&Free 100 - Ref. 058U) on welding area and on room edges



### HOT WELDING

for 100% watertight hygienic system (Ref. CR40 0585)



### COLD WELDING

for invisible joint (see Romus #95605)



### WALL TRANSITION

- Vynaflex skirtings, ideal for commercial applications (H 60 mm - Ref. 0483 / H 80 mm - Ref. 0482 / H 100 mm - Ref. 0477)
- Coving for 100% watertight hygienic system



### ENTRANCE MATS

A new quick & easy installation of entrance mats with Quickmat Tile (Ref. 1725)

More information on [gerflor.com](http://gerflor.com)

## YOUR SUSTAINABLE FLOORING SOLUTION!

### CIRCULAR ECONOMY

- 100% RECYCLABLE PRODUCT
- RECYCLED CONTENT:  
backing made with recycled PET



= 1m<sup>2</sup>



### INDOOR AIR QUALITY

ADHESIVE FREE INSTALLATION MEANS VIRTUALLY NO VOC!

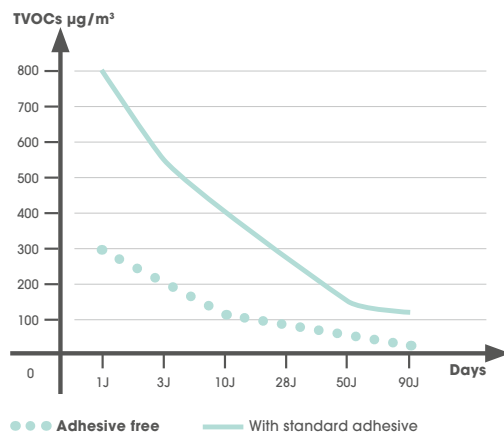

# TARALAY MULTILAYERED - FAST TRACK INSTALLATION

## TARALAY LIBERTEX

### ▶ TARALAY LIBERTEX

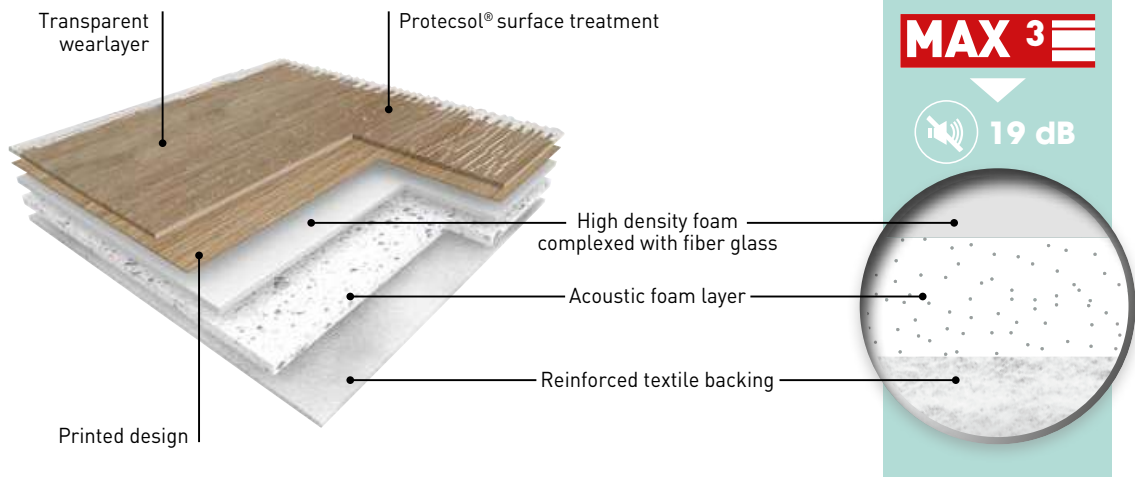

**TARALAY LIBERTEX** is ideal for fast track installation or renovations in commercial buildings. It is a multi-layered vinyl floorcovering with a printed design protected by a 0.70 mm thick transparent wear layer. The product features a high density foam complexed with fiber glass, an acoustic foam layer and a reinforced textile backing. It offers **19 dB sound insulation**.

It is available in 2 m and 4 m wide sheet, offers a R10 slip resistance and a group T wear rating. It is mechanically embossed, benefits from **Protexsol®** surface treatment and has an ultra matt look.

**TARALAY LIBERTEX** is a worry-free looselay solution. It is laid without glue, simply applying a double-sided tape such as Fix&Free on room edge and at the joint. Its textile backing absorbs surface irregularities requiring minimal subfloor preparation on uneven floors. It is compatible with cold welding, hot welding, coving, and Vynaflex skirtings.

It includes at least 30% mineral materials and 20% renewable materials. Textile backing is made at 95% from recycled PET bottles. It is 100% recyclable and 100% REACH compliant. Its VOC emissions after 28 days (ISO 16000) are below 100 microgram/m<sup>3</sup>. It is classified A+ (the best class) for indoor air quality.





# TARALAY LIBERTEX



## Fast track installation

- ▶ Minimal subfloor preparation: textile backing absorbs subfloor irregularities
- ▶ No shutdown, no odor, ideal for occupied rooms thanks to looselay installation
- ▶ No drying time, no glue

**Hygienic and easy maintenance:** Protecsol® surface treatment

**Comfort:** 19 dB sound reduction

Taralay  
Multilayered

			LIBERTEX
DESCRIPTION			
Total thickness	EN ISO 24346	mm	3.65
Thickness of wearlayer	EN ISO 24340	mm	0.70
Weight	EN ISO 23997	g/sqm	2900
Width of sheet	EN ISO 24341	cm	200/400
Length of sheet	EN ISO 24341	lm	20
CLASSIFICATION			
Norm / Product specification	-	-	EN ISO 11638
European classification	EN ISO 10874	class	34
Fire rating	EN 13501-1	class	Cfl-s1
Static electrical propensity	EN 1815	kV	< 2
Slip resistance wet	DIN 51 130	class	R10
PERFORMANCES			
Wear resistance	EN 660.2	mm <sup>3</sup>	≤ 2.0
Wear group	-	group	T
Dimensional stability (requirement)	EN ISO 23999	%	≤ 0.40
Dimensional stability (measured value)	-	-	≤ 0.05
Residual indentation (requirement)	EN ISO 24343-1	mm	≤ 0.20
Impact sound insulation	EN ISO 717-2	dB	19
Room impact	NF S 31 074	dB	< 65
Thermal conductivity	EN ISO 10456	W/(m.k)	0.25
Colour fastness	EN 20 105 - B02	degree	≥ 6
Surface treatment	-	-	Protecsol®
Chemical products resistance <sup>(1)</sup>	EN ISO 26987	-	OK
ENVIRONMENT / INDOOR AIR QUALITY			
TVOC after 28 days	ISO 16000-6	microgram/m <sup>3</sup>	< 100
CE MARKING			
CE	EN 14041		

(1) Regarding the resistance to chemicals, please download the corresponding leaflet from our website.

(2) The implementation of an effective cleaning regime is the most important defence against infection.

# TARALAY MULTILAYERED - FAST TRACK INSTALLATION

## TARALAY LIBERTEX - REFLECT



Textile Backing | 19 dB | Protecsol® | 100% recyclable



2253 Reflect Silver

Scale 1



2249 Reflect Sea



2252 Reflect Forest



2251 Reflect Sunny



1785 Reflect Earth



2252 Reflect Flower

2253 Reflect Silver / 2252 Reflect Flower

# TARALAY LIBERTEX - AMSTERDAM / PAROS



19 dB

Protocolsol®



100% recyclable



2151 Amsterdam Light Grey

## AMSTERDAM



2151 Amsterdam Light Grey

^ Scale 1



2152 Amsterdam Grey



2153 Amsterdam Anthracite



Taralay  
Multilayered



2248 Paros Clear

## PAROS



2248 Paros Clear

^ Scale 1



33.3 x 66.6 cm



# TARALAY MULTILAYERED - FAST TRACK INSTALLATION

## TARALAY LIBERTEX - WOOD



 19 dB | 
 
 Protocolsol® | 
 
 100% recyclable



2247 Hossegor Latte

### LEGEND



1430 - Legend Grey



No plank  
Continuous design



2243 - Legend Chestnut



No plank  
Continuous design



2242 - Legend Country



No plank  
Continuous design

### COCOON



2241 - Cocoon Silver Brown



No plank  
Continuous design

### HOSSEGOR



2247 - Hossegor Latte



10 x 100-67-33.3 cm

# TARALAY LIBERTEX - WOOD



19 dB

Protocolsol®



100% recyclable



2245 Skandi Oak Natural

## SKANDI OAK



2244 - Skandi Oak Clear



20x133,3 cm



2245 - Skandi Oak Natural



20 x 133,3 cm



2246 - Skandi Oak Toffee



20 x 133,3 cm



## PURE OAK



0720 - Pure Oak Clear



16 x 100 cm



1751 - Pure Oak Grey



16 x 100 cm



Taralay  
Multilayered

# TARALAY MULTILAYERED

## TARALAY IMPRESSION

### ▶ TARALAY IMPRESSION COMPACT / COMPACT PLUS

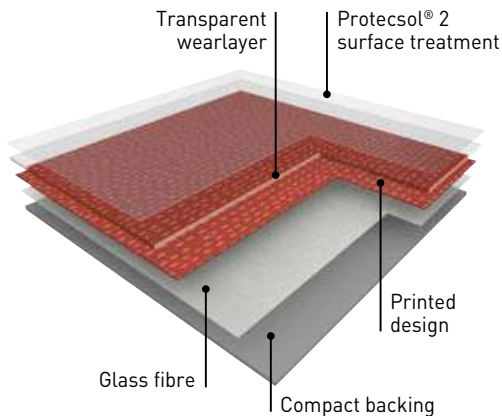

**TARALAY IMPRESSION COMPACT 0,7** is a multi-layered vinyl floorcovering, available in 2 m wide sheet, with a group T wear rating. The product comprises a compacted backing reinforced with a glass fibre and a printed design that is protected by a transparent wear layer (0.70 mm thick). **It offers 8 dB sound insulation and an indentation resistance of ca. 0.03 mm.**

**TARALAY IMPRESSION COMPACT PLUS 0,9** is a multi-layered vinyl floorcovering, available in 2 m wide sheet, with a group T wear rating.

The product comprises a compacted backing reinforced with a glass fibre and a printed design that is protected by a transparent wear layer (0.90 mm thick).

**It offers 8 dB sound insulation and an indentation resistance of ca. 0.03 mm.** The flooring is equipped with **Protecsol® 2**, patented surface treatment obtained by UV laser cross-linking offering the best chemical resistance to the main products used in healthcare environment as Betadine, eosin, hydro alcoholic solutions, making the maintenance easy and the floor long lasting. This treatment avoids applying any acrylic emulsion throughout the lifetime of the product.

According to ISO 21702, **TARALAY IMPRESSION** has **anti-viral activity** against Human Coronaviruses: it reduces the number of virus by 99.7% after 2h.

According to ISO 22196, **TARALAY IMPRESSION** has **anti-bacterial activity** against E. coli, S. aureus and MRSA of 99% after 24h.

It is free of formaldehyde, heavy metals and CMR 1 & 2 or vPvB (very persistent and very bio-accumulative) or PBT (persistent, bio-accumulative and toxic) and is 100% REACH compliant. Its VOC emissions after 28 days (ISO 16000-6) are below detection levels (< 10 microgram/m<sup>3</sup>) and this product is classified A+ (the best class) and Floorscore® & M1 certified for indoor air quality.

### ▶ TARALAY IMPRESSION COMFORT / COMFORT PLUS

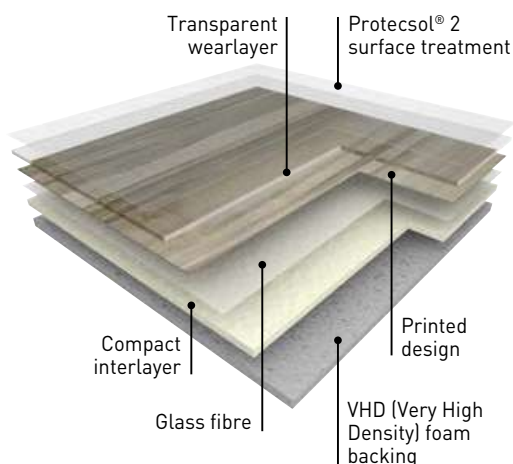

**TARALAY IMPRESSION COMFORT 0,65** is an acoustic multi-layered vinyl floorcovering, available in 2 m wide sheet, with a group T wear rating. The product comprises a Very High Density (VHD) foam backing reinforced with a glass fibre and a printed design that is protected by a transparent wear layer (0.65 mm thick). **It offers 19 dB sound insulation and an indentation resistance of ca. 0.08 mm.**

**TARALAY IMPRESSION COMFORT PLUS 0,9** is an acoustic multi-layered vinyl floorcovering, available in 2 m wide sheet, with a group T wear rating. The product comprises a Very High Density (VHD) foam backing reinforced with a glass fibre and a printed design that is protected by a transparent wear layer (0.90 mm thick). **It offers 19 dB sound insulation and an indentation resistance of ca. 0.08 mm.**

The flooring is equipped with **Protecsol® 2**, patented surface treatment obtained by UV laser cross-linking offering the best chemical resistance to the main products used in healthcare environment as betadine, eosin, hydro alcoholic solutions, making the maintenance easy and the floor long lasting. This treatment avoids applying any acrylic emulsion throughout the lifetime of the product.

According to ISO 21702, **TARALAY IMPRESSION** has **anti-viral activity** against Human Coronaviruses: it reduces the number of virus by 99.7% after 2h.

According to ISO 22196, **TARALAY IMPRESSION** has **anti-bacterial activity** against E. coli, S. aureus and MRSA of 99% after 24h.

It is free of formaldehyde, heavy metals and CMR 1 & 2 or vPvB (very persistent and very bio-accumulative) or PBT (persistent, bio-accumulative and toxic) and is 100% REACH compliant. Its VOC emissions after 28 days (ISO 16000-6) are below detection levels (< 10 microgram/m<sup>3</sup>) and this product is classified A+ (the best class) and Floorscore® & M1 certified for indoor air quality.



# TARALAY IMPRESSION



19 dB



Protecsol® 2



100% recyclable

► **Ultra-realistic designs:**

Realistic embosses and plank dimensions for wood designs

► **Matt effect**

► **Extreme stain resistance, easy maintenance:**

Protecsol® 2 surface treatment (patented technology by Gerflor)

► **High traffic resistance, long-lasting appearance**

Available with a 0.7 mm wearlayer and available with a 0.9 mm wearlayer upon request (minimum order quantity of 800 sqm)

► **The best acoustic / indentation performance on the market**

COMPACT: 0.03 mm / 8 dB

COMFORT: 0.08 mm / 19 dB

► **Eco-responsible solution**

Best in class for indoor air quality (TVOC < 10 microgram/m<sup>3</sup> after 28 days)

Taralay  
Multilayered

			TARALAY IMPRESSION COMPACT	TARALAY IMPRESSION COMPACT PLUS	TARALAY IMPRESSION COMFORT	TARALAY IMPRESSION COMFORT PLUS
<b>DESCRIPTION</b>						
Total thickness	EN ISO 24346	mm	2.00	2.25	3.35	3.55
Wearlayer Thickness	EN ISO 24340	mm	0.70	0.90	0.65	0.90
Weight	EN ISO 23997	g/sqm	2635	2975	2825	3265
Width of sheet	EN ISO 24341	cm	200	200	200	200
Length of sheet	EN ISO 24341	lm	25	20	25	20
<b>CLASSIFICATION</b>						
Norm / Product specification	-	-	EN ISO 10582	EN ISO 10582	EN ISO 11638	EN ISO 11638
European classification	EN ISO 10874	class	34-43	34 - 43	34-42	34 - 42
Fire rating	EN 13501-1	class	Bfl-s1	Cfl-s1	Bfl-s1	Cfl-s1
Static electrical propensity	EN 1815	kV	< 2	< 2	< 2	< 2
Slip resistance	DIN 51 130	class	R10	R10	R10	R10
<b>PERFORMANCES</b>						
Wear resistance	EN 660.2	mm <sup>3</sup>	≤ 2.0	≤ 2.0	≤ 2.0	≤ 2.0
Wear group	-	group	T	T	T	T
Type Binder content	EN ISO 10582	type	I	I	-	-
Dimensional stability	EN ISO 23999	%	≤ 0.40	≤ 0.40	≤ 0.40	≤ 0.40
Residual indentation (requirement)	EN ISO 24343-1	mm	≤ 0.10	≤ 0.10	≤ 0.20	≤ 0.20
Residual indentation (average measured value)	-	mm	≈ 0.03	≈ 0.03	≈ 0.08	≈ 0.08
Impact sound insulation	EN ISO 717-2	dB	8	8	19	19
Castor chair test (type H)	ISO 4918	-	OK	OK	OK	OK
Thermal conductivity	EN ISO 10456	W/(m.k)	0.25	0.25	0.25	0.25
Colour fastness	EN 20 105 - B02	degree	≥ 6	≥ 6	≥ 6	≥ 6
Surface treatment	-	-	PROTECSOL® 2	PROTECSOL® 2	PROTECSOL® 2	PROTECSOL® 2
Chemical products resistance <sup>(1)</sup>	EN ISO 26987	-	OK	OK	OK	OK
Anti-bacterial activity (E. coli - S. aureus - MRSA) after 24h <sup>(2)</sup>	ISO 22196	-	> 99% inhibits growth	> 99% inhibits growth	> 99% inhibits growth	> 99% inhibits growth
Anti-viral activity (human coronavirus) after 2h <sup>(2)</sup>	ISO 21702	-	> 99.7% virucidal activity	> 99.7% virucidal activity	> 99.7% virucidal activity	> 99.7% virucidal activity
<b>ENVIRONMENT / INDOOR QUALITY AIR</b>						
TVOC after 28 days	ISO 16000-6	microgram/m <sup>3</sup>	< 10	< 10	< 10	< 10
Certification	-	-	Floorscore®	Floorscore®	Floorscore®	Floorscore®
<b>CE MARKING</b>						
CE	EN 14041					

(1) Regarding the resistance to chemicals, please download the corresponding leaflet from our website.

(2) The implementation of an effective cleaning regime is the most important defence against infection.

# TARALAY MULTILAYERED

## TARALAY IMPRESSION - CORNER



Compact | 
 Comfort | 
 19 dB | 
 VHD | 
 Protocolsol® 2 | 
 100% recyclable



0733 Corner Copper



0733 Corner Copper

^ Scale 1



0732 Corner Dark Blue



0728 Corner Offwhite



0740 Corner Turquoise



0729 Corner Metal



0739 Corner Anis



0730 Corner Light Beige



0741 Corner Tomette



# TARALAY IMPRESSION - KUBES



19 dB



Protecsol® 2



100% recyclable



0748 Kubes Burgundy / 0754 Kubes Blue

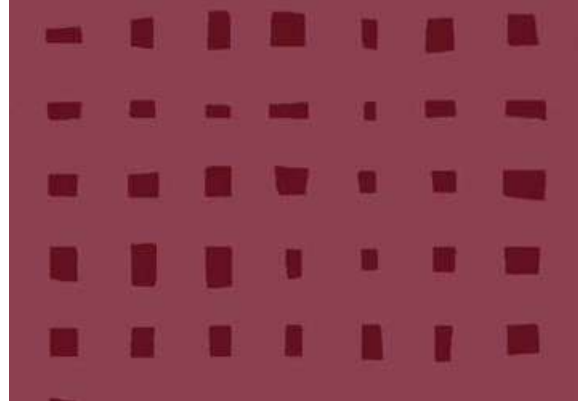

0748 Kubes Burgundy

Scale 1



0750 Kubes Sun



0749 Kubes Sky



0747 Kubes Olive



0754 Kubes Blue



0751 Kubes Taupe



0753 Kubes Grey



0756 Kubes Beige



0755 Kubes White



0752 Kubes Gold



Taralay  
Multilayered



# TARALAY MULTILAYERED

## TARALAY IMPRESSION - RICE



19 dB



Protecsol® 2



100% recyclable



0736 Rice Champagne

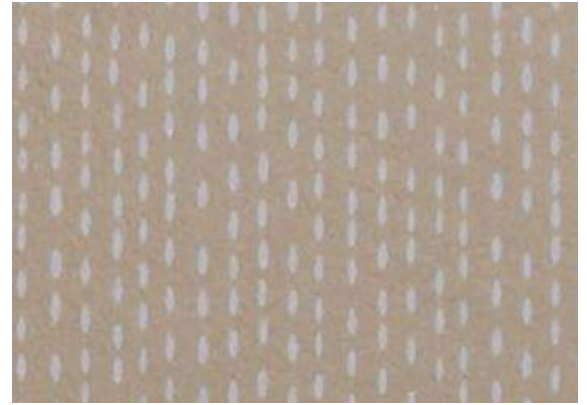

0736 Rice Champagne

^ Scale 1



0763 Rice Greige



0737 Rice Souris



0762 Rice Brown



0758 Rice Sea



0738 Rice Copper



0735 Rice Light Green



0757 Rice Coquellcot



0759 Rice Mustard



# TARALAY IMPRESSION - STARS / NEST



19 dB



Protocolsol® 2



100% recyclable



0743 Stars Baltique

## STARS



0743 Stars Baltique

^ Scale 1



0764 Stars Orange



0744 Stars Anthracite



19 dB



Protocolsol® 2



100% recyclable



0746 Nest Black

## NEST

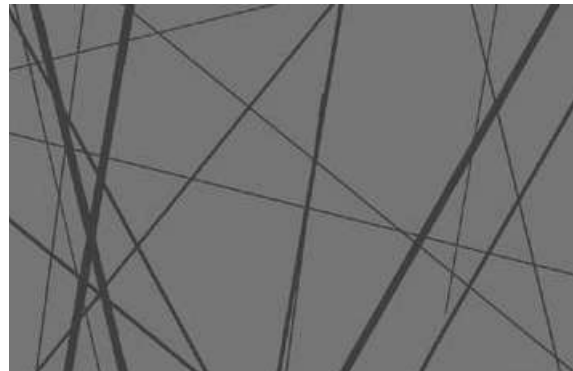

0746 Nest Black

^ Scale 1



0745 Nest Metal



0765 Nest Taupe



Taralay  
Multilayered

# TARALAY MULTILAYERED

## TARALAY IMPRESSION - UNI MATT / LEATHER



Compact
 Comfort
 **19 dB**
 VHD
 **Protocols® 2**
 100% recyclable



0837 Uni Matt Blue



0837 Uni Matt Blue

^ Scale 1

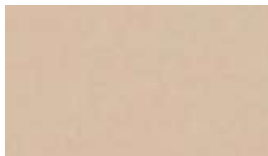

0833 Uni Matt Beige

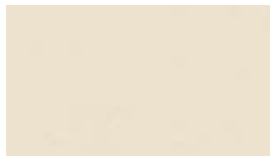

0848 Uni Matt White



0836 Uni Matt Tomette



0839 Uni Matt Turquoise



0834 Uni Matt Brown



0832 Uni Matt Grey



0835 Uni Matt Orange



0842 Uni Matt Olive



0831 Uni Matt Anthracite



0838 Uni Matt Dark Blue



0849 Uni Matt Sun



0840 Uni Matt Anis



0844 Leather Marine



0844 Leather Marine

^ Scale 1



0843 Leather Grey



0845 Leather Greige





# TARALAY IMPRESSION - CEMENTO / MOHAIR



19 dB



Protecsol® 2



100% recyclable



0524 Cemento Capri

## CEMENTO

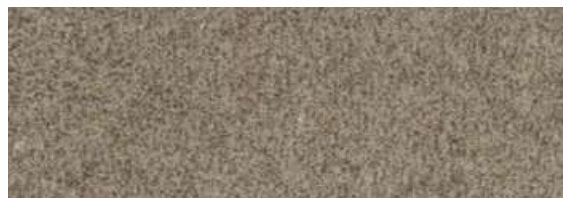

0524 Cemento Capri

^ Scale 1

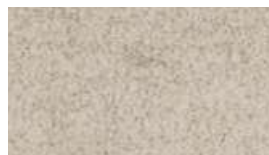

0523 Cemento Genova



0543 Cemento Brescia



0525 Cemento Modena



Taralay  
Multilayered



0766 Mohair Dark

## MOHAIR



0766 Mohair Dark

^ Scale 1

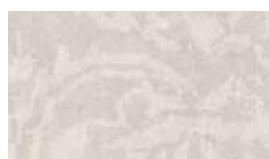

0769 Mohair White

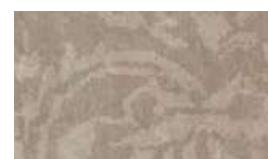

0767 Mohair Natural



# TARALAY MULTILAYERED

## TARALAY IMPRESSION - TRAME / GENTLEMEN



Compact
 Comfort
 **19 dB**
 VHD
 Protocolsol® 2
 100% recyclable



0777 Trame Rose

### TRAME

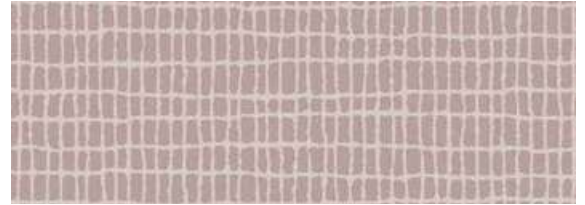

0777 Trame Rose

^ Scale 1



0774 Trame Clear

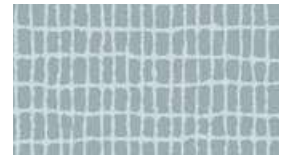

0775 Trame Blue



0776 Trame Beige



0771 Gentlemen Grey

### GENTLEMEN



0771 Gentlemen Grey

^ Scale 1



0772 Gentlemen Coffee



0770 Gentlemen Clear





# TARALAY IMPRESSION - WOOD



19 dB



Protecsol® 2



100% recyclable



## HERRINGBONE



0722 - Herringbone Blond



16.6 cm



0724 - Herringbone Chatain



16.6 cm

## HABANA



0538 - Habana Vinales



16.6 cm



0522 - Habana Trinidad



16.6 cm

## PORTOBELLO



0773 - Portobello



16.6 cm

Taralay  
Multilayered

0722 Herringbone Blond / 0538 Habana Vinales



# TARALAY MULTILAYERED

## TARALAY IMPRESSION - WOOD



19 dB



Protocols® 2



100% recyclable



0725 Sycamore Light Brown

### SYCAMORE



0727 - Sycamore Vanilla



No plank  
Continuous design



0726 - Sycamore Dark



No plank  
Continuous design



0725 - Sycamore Light Brown



No plank  
Continuous design

### INFINITY



0720 - Infinity Aube



No plank  
Continuous design



0680 - Infinity Greige



No plank  
Continuous design



0719 - Infinity Lichen



No plank  
Continuous design

# TARALAY IMPRESSION - WOOD



19 dB



Protocols® 2



100% recyclable



0373 Noma Ice

## NOMA



0371 - Noma Rustic



16.6 cm



0373 - Noma Ice



16.6 cm



0519 - Noma Beige



16.6 cm



0025 Renzo Taupe

## RENZO



0068 - Renzo Pecan



No plank  
Continuous design



0025 - Renzo Taupe



No plank  
Continuous design

Taralay  
Multilayered

# TARALAY MULTILAYERED

## TARALAY IMPRESSION - WOOD



Compact | Comfort | 19 dB | VHD | Protecsol® 2 | 100% recyclable



### CHARME



0723 - Charme Pecan



20 cm



0721 - Charme Natural



20 cm



### MOON ISLAND



0760 - Moon Island



16,6 cm



# TARALAY IMPRESSION - WOOD



19 dB



Protocols® 2



100% recyclable



0671 Loft Light Brown

## LOFT



0671 - Loft Light Brown



11.2 / 14.2 / 8.7 / 6.4 cm



0734 - Loft Chestnut



11.2 / 14.2 / 8.7 / 6.4 cm



1314 Walnut Brown

## WALNUT



0528 - Walnut Cream



10 cm



1314 - Walnut Brown



10 cm



TARALAY IMPRESSION		PLANKS SIZES IN CM		
Colour Reference	Colour Name	Pattern Repeat in mm	Length	Width
0519	Noma Beige	1000 X 1000	100	16.6
0373	Noma Ice	1000 X 1000	100	16.6
0371	Noma Rustic	1000 X 1000	100	16.6
0538	Habana Vinales	1000 X 1000	100	16.6
0552	Habana Trinidad	1000 X 1000	100	16.6
0528	Walnut Cream	1000 X 1000	100	10
1314	Walnut Brown	1000 X 1000	100	10
0671	Loft Light Brown	1000 X 1000	100	11.2-14.2-8.7-6.4
0734	Loft Chestnut	1000 X 1000	100	11.2-14.2-8.7-6.4
0721	Charme Natural	1000 X 1000	100	20
0723	Charme Pecan	1000 X 1000	100	20
0760	Moonisland	1000 X 1000	100	16.6
0773	Portobello	1000 X 1000	100	16.6
0722	Herringbone Blond	1000 X 1000	100	16.6
0724	Herringbone Chatain	1000 X 1000	100	16.6

Taralay  
Multilayered

# TARALAY MULTILAYERED

## TARALAY INITIAL New

### ▶ TARALAY INITIAL COMPACT

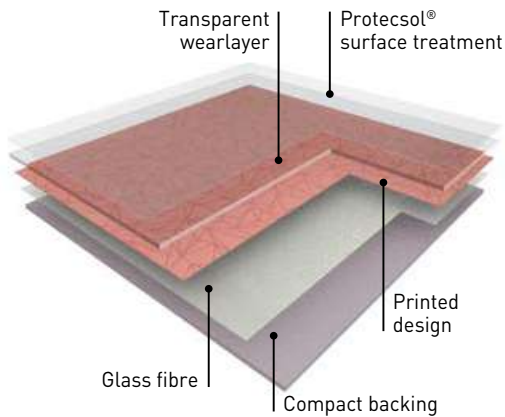

**TARALAY INITIAL COMPACT** is a multi-layered vinyl floorcovering, available in 2 m wide sheet, with a group T wear rating.

The product comprises a compacted backing reinforced with a glass fibre and a printed design that is protected by a transparent wear layer (0.70 mm thick). It offers 6 dB sound insulation and an indentation resistance of 0.03 mm.

It is treated with **Protecsol®**, a UV cured surface treatment, which facilitates ease of maintenance and eliminates permanently the need for acrylic emulsion (metallisation).

According to ISO 21702, **TARALAY INITIAL COMPACT** has **anti-viral activity** against Human Coronaviruses: it reduces the number of virus by 99.3% after 2h.

According to ISO 22196, **TARALAY INITIAL COMPACT** has **anti-bacterial activity** against E. coli, S. aureus and MRSA of 99% after 24h.

These products do not contain any heavy metals or CMR 1&2 and are 100% compliant with REACH. The products emission rate of volatile organic compounds is < 10 microgram/m<sup>3</sup> (TVOC after 28 days – ISO 16000-6). It is 100% recyclable.

### ▶ TARALAY INITIAL COMFORT

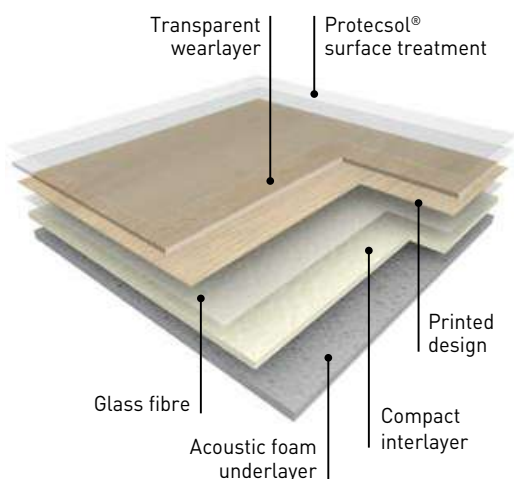

**TARALAY INITIAL COMFORT** is an acoustic multi-layered vinyl floorcovering, available in 2 m wide sheet, with a group T wear rating.

The product comprises a foam backing reinforced with a glass fibre and a printed design that is protected by a transparent wear layer (0.65 mm thick). It offers 19 dB sound insulation and an indentation resistance of 0.10 mm.

It is treated with **Protecsol®**, a UV cured surface treatment, which facilitates ease of maintenance and eliminates permanently the need for acrylic emulsion (metallisation).

According to ISO 21702, **TARALAY INITIAL COMFORT** has **anti-viral activity** against Human Coronaviruses: it reduces the number of virus by 99.3% after 2h.

According to ISO 22196, **TARALAY INITIAL COMFORT** has **anti-bacterial activity** against E. coli, S. aureus and MRSA of 99% after 24h.

It does not contain any heavy metals or CMR 1&2 and is 100% compliant with REACH. The products emission rate of volatile organic compounds is < 10 microgram/m<sup>3</sup> (TVOC after 28 days – ISO 16000-6). It is 100% recyclable.

# TARALAY INITIAL New



19 dB

Protecsol®

100% recyclable

- ▶ All references are available in **Compact** and **Comfort**
- ▶ High resistance to indentation **0.03 mm (Compact)** and **0.10 mm (Comfort)**
- ▶ High impact insulation **6 dB (Compact)** and **19 dB (Comfort)**
- ▶ **Protecsol®** Surface Treatment (easy maintenance & no wax)
- ▶ Highest performance in **TVOC emission < 10 microgram/m³**

Taralay  
Multilayered

			TARALAY INITIAL COMPACT PRO	TARALAY INITIAL COMFORT PRO
<b>DESCRIPTION</b>				
Total thickness	EN ISO 24346	mm	2.00	3.35
Thickness of wearlayer	EN ISO 24340	mm	0.70	0.65
Weight	EN ISO 23997	g/sqm	2635	2825
Width of sheet	EN ISO 24341	cm	200	200
Length of sheet	EN ISO 24341	lm	25	25
<b>CLASSIFICATION</b>				
Norm / Product specification	-	-	EN ISO 10582	EN ISO 11638
European classification	EN ISO 10874	class	34-43	34-42
Fire rating	EN 13501-1	class	Bfl-s1	Bfl-s1
Static electrical propensity	EN 1815	kV	< 2	< 2
Slip resistance wet	DIN 51 130	class	R10	R10
<b>PERFORMANCES</b>				
Wear resistance	EN 660.2	mm³	≤ 2.0	≤ 2.0
Wear group	-	group	T	T
Type Binder content	EN ISO 10582	type	I	-
Dimensional stability	EN ISO 23999	%	≤ 0.40	≤ 0.40
Residual indentation (requirement)	EN ISO 24343-1	mm	≤ 0.10	≤ 0.20
Residual indentation (average measured value)	-	mm	≈ 0.03	≈ 0.10
Impact sound insulation	EN ISO 717-2	dB	6	19
Castor chair test (type H)	ISO 4918	-	OK	OK
Thermal conductivity	EN ISO 10456	W/(m.k)	0.25	0.25
Colour fastness	EN 20 105 - B02	degree	≥ 6	≥ 6
Surface treatment	-	-	Protecsol®	Protecsol®
Chemical products resistance	EN ISO 26987	-	OK	OK
Anti-bacterial activity (E. coli - S. aureus - MRSA) <sup>(1)</sup>	ISO 22196	-	> 99% inhibits growth	> 99% inhibits growth
Anti-viral activity (human coronavirus) after 2h <sup>(1)</sup>	ISO 21702	-	> 99.3% virucidal activity	> 99.3% virucidal activity
<b>ENVIRONMENT / INDOOR AIR QUALITY</b>				
TVOC after 28 days	ISO 16000-6	microgram/m³	< 10	< 10
Certification	-	-	Floorscore®	Floorscore®
<b>CE MARKING</b>				
	EN 14041			

<sup>(1)</sup> The implementation of an effective cleaning regime is the most important defence against infection.



# TARALAY MULTILAYERED

## TARALAY INITIAL - DIVERSION New

  **19 dB** | **Protecsol®** |  **100% recyclable**

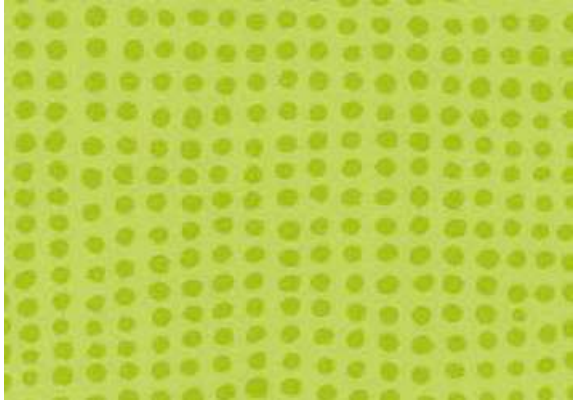

0515 Diversion Kiwi

^ Scale 1



0949 Diversion Soleil



0825 Diversion Turquoise

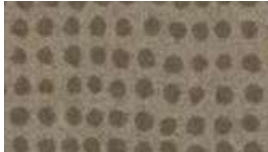

0049 Diversion Carbone



0962 Diversion Marine



0047 Diversion Ivoire



0824 Diversion Souris



# TARALAY INITIAL - MIAMI New

 Compact | 
  Comfort | 
  Comfort 50x50cm | 
 19 dB | 
 Protecsol® | 
  100% recyclable



0952 Miami Soleil

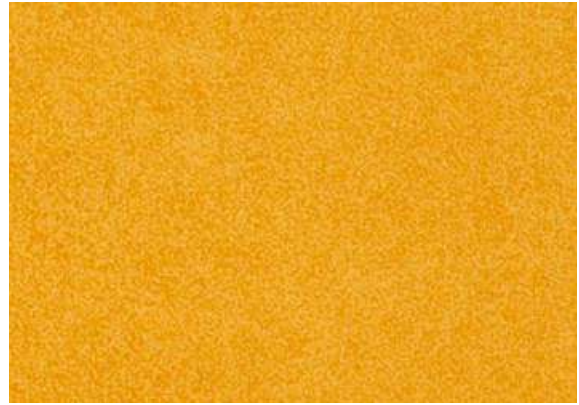

0952 Miami Soleil ^ Scale 1  





0950 Miami Sable  





0963 Miami Perle  





0966 Miami Abricot  

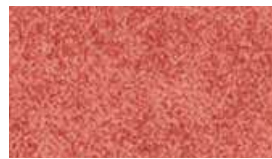

0968 Miami Ciel  

0951 Miami Litchee  



0967 Miami Mer  



0970 Miami Taupe  

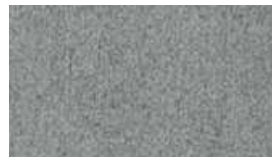

0965 Miami Foret  

0964 Miami Souris  



0969 Miami Paon  

Taralay Multilayered



# TARALAY MULTILAYERED

## TARALAY INITIAL - SPIDER New



**19 dB** | **ProtecSol®** |  **100% recyclable**



0974 Spider Saphir

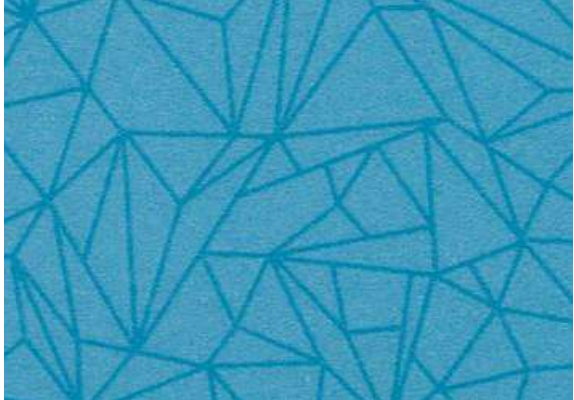

0974 Spider Saphir

^ Scale 1



0976 Spider Quartz



0954 Spider Dore



0956 Spider Grenat



0957 Spider Cuivre



0975 Spider Emeraude



0955 Spider Perle

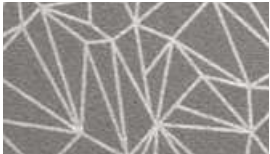

0973 Spider Alu





# TARALAY INITIAL - URBAN / STRADA New



19 dB

Protocolsol®



100% recyclable



0035 Urban Gris

## URBAN

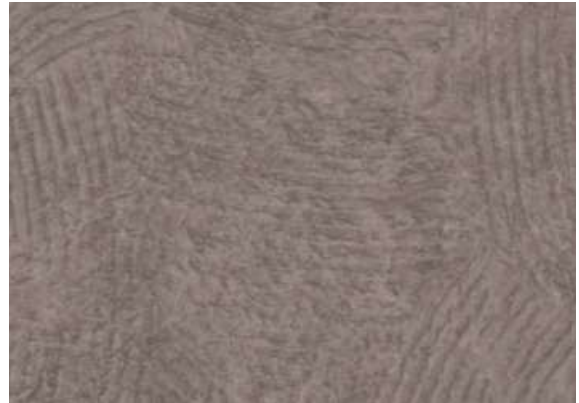

0035 Urban Gris

^ Scale 1

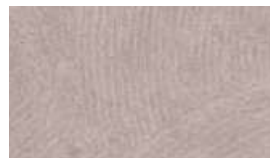

0037 Urban Souris



0958 Urban Beige



0791 Strada Metallic

## STRADA



0791 Strada Metallic

^ Scale 1



0790 Strada Chrome



0465 Strada Ciment



Taralay  
Multilayered

# TARALAY MULTILAYERED

## TARALAY INITIAL - WOOD New

 Compact | 
  Comfort | 
  Comfort 25x100cm | 
 19 dB | 
 ProtecSol® | 
  100% recyclable



0826 Filament Grey

### FILAMENT



0826 Filament Grey   No plank Continuous design 



0799 Filament Light    No plank Continuous design 

### RENZO



0590 Renzo Steel   No plank Continuous design 



0636 Esterel Blond

### ESTEREL



0636 Esterel Blond   10 cm 

# TARALAY INITIAL - WOOD New

  **19 dB** | **Protocolsol®** |  **100% recyclable**



0828 Habana Beige

## HABANA



0797 Habana Ivory



16.7 cm 



0828 Habana Beige



16.7 cm 

Taralay  
Multilayered



0698 Noma Naturel

## NOMA



0588 Noma Clair



16.7 cm 



0698 Noma Naturel



16.7 cm 



# TARALAY MULTILAYERED

## TARALAY INITIAL - WOOD New

   **19 dB** | **Protocolsol®** |  **100% recyclable**



0773 Ranch

### RANCH



0773 Ranch  16.7 cm 



0953 Ranch Anthracite  16.7 cm 

### BOSTONIAN



0961 Bostonian Honey  20 cm 



0959 Bostonian Brown  20 cm 



0960 Bostonian Grey  20 cm 

# TARALAY INITIAL - WOOD New



19 dB

Protocolsol®

100% recyclable



0977 Twist Grey

## TWIST



0977 Twist Grey



16.7 cm



0979 Twist White



16.7 cm



0978 Twist Blond



16.7 cm



0980 Twist Brown



16.7 cm

Design name	Colour Reference	Colour Name	Pattern Repeat in m	Planks Sizes in cm	
				Length	Width
Bostonian	0959	Brown	1 m x 1 m	100	20
Bostonian	0960	Grey	1 m x 1 m	100	20
Bostonian	0961	Honey	1 m x 1 m	100	20
Esterel	0636	Blond	1 m x 1 m	100	10
Habana	0828	Beige	1 m x 1 m	100	16.7
Habana	0638	Ivory	1 m x 1 m	100	16.7
Noma	0588	Clair	1 m x 1 m	100	16.7
Noma	0698	Naturel	1 m x 1 m	100	16.7
Ranch	0773	Ranch	1 m x 1 m	100	16.7
Ranch	0953	Ranch Anthracite	1 m x 1 m	100	16.7
Twist	0978	Blond	1 m x 1 m	100	16.7
Twist	0980	Brown	1 m x 1 m	100	16.7
Twist	0977	Grey	1 m x 1 m	100	16.7
Twist	0979	White	1 m x 1 m	100	16.7

Taralay Multilayered

# TARALAY MULTILAYERED

## TIMBERLINE

### ▶ TIMBERLINE

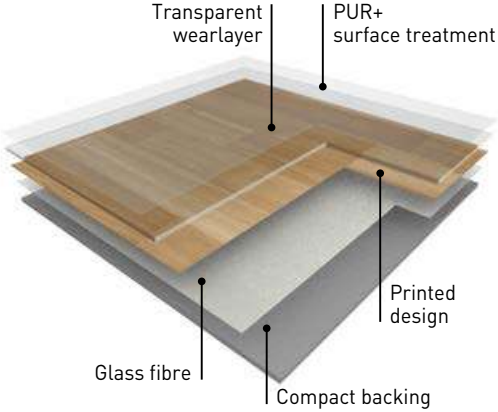

**TIMBERLINE** is a multilayered, compact floorcovering, available in 2 or 4 m wide sheet with a group T wearing,

The product comprises a compacted backing reinforced with a glass fibre and a printed design that is protected by a transparent wear layer (0.70 mm thick). It offers 6 dB sound insulation and an indentation resistance of 0.05 mm.

It is treated with **PUR+**, a surface treatment, which facilitates maintenance and avoids a first acrylic emulsion (metallisation).

This coating is antistatic (Class 1).

This products does not contain any heavy metals or CMR 1&2 and is 100% compliant with REACH. The product emission rate of volatile organic compounds is < 100 microgram/m<sup>3</sup> (TVOC after 28 days – ISO 16000-6). It is 100% recyclable.



1893 Harbor Blue



# TIMBERLINE



6dB

PUR+



- ▶ **TIMBERLINE collection** available in both 2 and 4 m with a 2.00 mm thickness
  - **Wood:** 24 references
  - **Pixel:** 14 references

- ▶ All references available in Compact sheet
- ▶ **PUR+** Polyurethane surface treatment:
  - Easy maintenance

Taralay  
Multilayered

			TIMBERLINE
<b>DESCRIPTION</b>			
Total thickness	EN ISO 24346	mm	2.00
Thickness of wearlayer	EN ISO 24340	mm	0.70
Weight	EN ISO 23997	g/sqm	2560
Width of sheet	EN ISO 24341	cm	200 /400
Length of sheet	EN ISO 24341	lm	20
<b>CLASSIFICATION</b>			
Norm / Product specification	-	-	EN ISO 10582
European classification	EN ISO 10874	class	34-43
Fire rating	EN 13501-1	class	Bfl-s1
Static electrical propensity	EN 1815	kV	< 2
Slip resistance wet	DIN 51 130	class	R10
<b>PERFORMANCES</b>			
Wear resistance	EN 660.2	mm <sup>3</sup>	≤ 2.0
Wear group	-	group	T
Type Binder content	EN ISO 10582	type	I
Dimensional stability	EN ISO 23999	%	≤ 0.40
Residual indentation (requirement)	EN ISO 24343-1	mm	≤ 0.10
Residual indentation (average measured value)	-	mm	≈ 0.05
Impact sound insulation	EN ISO 717-2	dB	≈ 6
Castor chair test (type H)	ISO 4918	-	OK
Thermal conductivity	EN ISO 10456	W/(m.k)	0.25
Colour fastness	EN 20 105 - B02	degree	≥ 6
Surface treatment	-	-	PUR+
Chemical products resistance <sup>(1)</sup>	EN ISO 26987	-	OK
<b>ENVIRONMENT / INDOOR AIR QUALITY</b>			
TVOC after 28 days	ISO 16000-6	microgram/m <sup>3</sup>	< 100
<b>CE MARKING</b>			
	EN 14041		

(1) Regarding the resistance to chemicals, please download the corresponding leaflet from our website.

# TARALAY MULTILAYERED

## TIMBERLINE WOOD

 **6 dB** | **PUR+** |  **100% recyclable**



0137 Aurore Natural

### AURORE



0137 Aurore Natural  7.5 cm 

### MAPLE



0422 Maple Light  7 cm 

### CABANA OAK



0492 Cabana Oak Brown  16 cm 

### NOMA



0476 Noma Miel  16.6 cm 



1451 Noma Kola  16.6 cm 

# TIMBERLINE WOOD



6 dB

PUR+



100% recyclable



0452 Oak Select Medium

## TORONTO



0449 Toronto Miel



16.8 cm

## OAK



0847 Oak Light



6.2 cm

## CHENE



0669 Chene Light



6.2 cm

## OAK SELECT



0452 Oak Select Medium



No strip  
Continuous design



0502 Oak Select Grey



No strip  
Continuous design

Taralay  
Multilayered



# TARALAY MULTILAYERED

## TIMBERLINE WOOD

 **6 dB** | **PUR+** |  **100% recyclable**



1893 Harbor Blue

### SHERWOOD



2015 Sherwood Brown  25 cm 



2017 Sherwood Grey  25 cm 



2012 Sherwood Clear  25 cm 

### HARBOR



1893 Harbor Blue  Variable widths & lengths 



1900 Harbor Nature  Variable widths & lengths 

# TIMBERLINE WOOD



6 dB

PUR+

100% recyclable



1751 Timber Grey

## WHITWASHED OAK



0542 Whitewashed Oak Warm Grey



16.6 cm

## WALNUT



0562 Walnut Grey Brown



10 cm

## RUSTIC PINE



0432 Rustic Pine Warm Grey



10 cm

## TIMBER



1751 Timber Grey



16 cm

Taralay  
Multilayered

# TARALAY MULTILAYERED

## TIMBERLINE WOOD

 **6 dB** | **PUR+** |  **100% recyclable**



2006 Cognac Pearl

### COGNAC



2006 Cognac Pearl  20 cm 



2007 Cognac Blond  20 cm 

### BRUGES



2010 Bruges Naturel  Variable widths & lengths 



1971 Bruges Clear  Variable widths & lengths 

### FACTORY



1518 Factory White  16.6 cm 



# TIMBERLINE PIXEL



6 dB

PUR+

100% recyclable



0597 Pixel Silver



Scale 1



2183 Pixel Earth

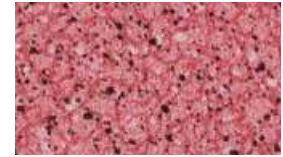

2188 Pixel Raspberry

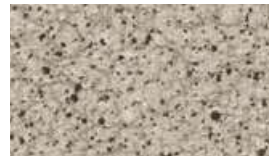

2176 Pixel Taupe

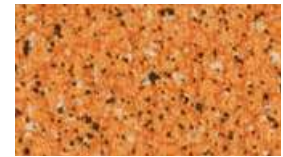

2178 Pixel Paprika



0597 Pixel Silver

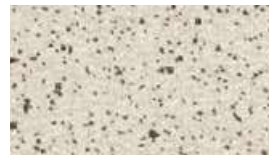

2175 Pixel Clear



0621 Pixel Vanilla



0639 Pixel Sand



2180 Pixel Light Green



0632 Pixel Anthracite

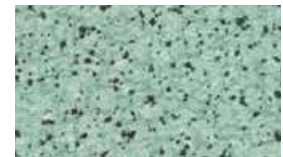

2181 Pixel Meadow



2179 Pixel Black

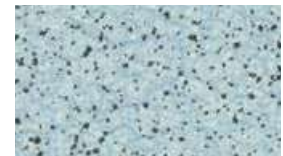

2177 Pixel Sky

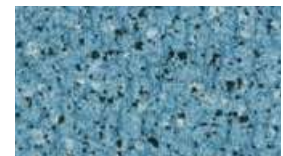

2182 Pixel Ocean



Taralay  
Multilayered

# TARALAY MULTILAYERED

## TARASTEP

### ▶ TARASTEP.....

ON THE WHOLE RANGE  
MORE THAN  
**70%**  
CONTRAST

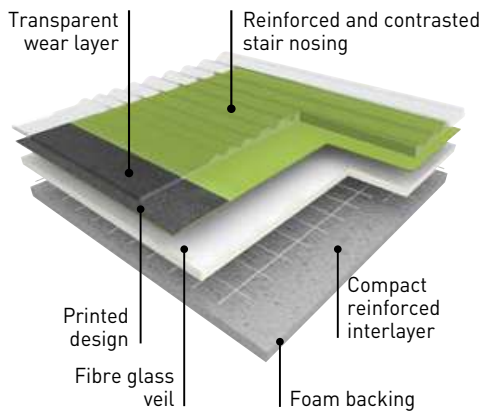

**TARASTEP** is a multilayered and foam backed complete step with a thickness of 3.35 mm. It comprises a printed design, a vinyl transparent wear layer and a specific embossing on stair nosing for safety.

It is an all-in-one stair covering comprising the stair tread, a ribbed nosing in a contrasted colour and the stair riser. All references have a 70% contrast level between stair tread and stair nosing to increase visibility for visually impaired people.

**TARASTEP** provides high sound insulation (17 dB).

The emissions of VOC after 28 days (NF EN 16000) are < 100 microgram/m<sup>3</sup>.

It is 100% recyclable.

### ▶ ACCESS FOR ALL (More details - See pages 300-301) .....

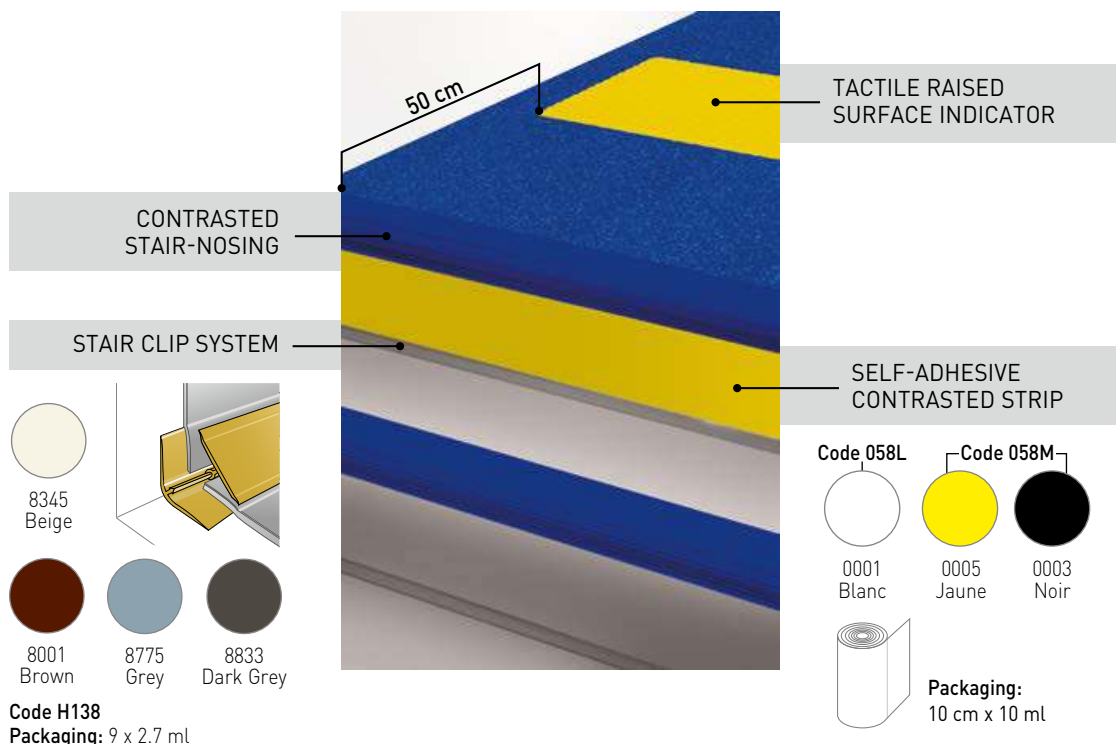

# TARASTEP



17 dB



100% recyclable

Taralay  
Multilayered

## TARASTEP

DESCRIPTION			
Total thickness	EN ISO 24346	mm	3.35
Thickness of wearlayer	EN ISO 24340	mm	0.85
Weight	EN ISO 23997	g/sqm	3100
Width of sheet	EN ISO 24341	cm	101
Length of sheet	EN ISO 24341	lm	20
CLASSIFICATION			
Norm / Product specification	-	-	EN ISO 11638
European classification	EN ISO 10874	class	34-42
Impact sound insulation	EN ISO 717-2	dB	17
Fire rating	EN 13501-1	class	Cfl-s1
Static electrical propensity	EN 1815	kV	< 2
PERFORMANCES			
Wear resistance	EN 660.2	mm <sup>3</sup>	≤ 2.0
Wear group	-	group	T
Dimensional stability	EN ISO 23999	%	≤ 0.40
Residual indentation (requirement)	EN ISO 24343-1	mm	≤ 0.20
Residual indentation (average measured value)	-	-	0.11
Thermal conductivity	EN ISO 10456	W/(m.k)	0.25
Colour fastness	EN 20 105 - B02	degree	≥ 6
Chemical products resistance	EN ISO 26987	-	OK
ENVIRONMENT / INDOOR QUALITY AIR			
TVOC after 28 days	ISO 16000-6	microgram/m <sup>3</sup>	< 100
CE MARKING			
CE	EN 14041		



# TARALAY MULTILAYERED

## TARASTEP

 Comfort
  100% recyclable

ON THE WHOLE RANGE  
MORE THAN  
**70%**  
CONTRAST



0702 Chamois / Marron  
**71.2%**  
CONTRAST



0701 Taupe / Gris Clair  
**77.3%**  
CONTRAST



0703 Noisette / Beige  
**75.2%**  
CONTRAST



0721 Brun / Beige Clair  
**70.5%**  
CONTRAST

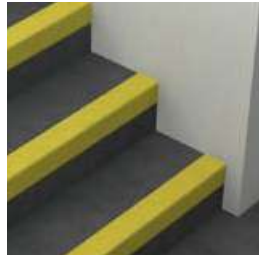

0719 Carbone / Jaune  
**72.9%**  
CONTRAST

# TARASTEP

ON THE WHOLE RANGE  
MORE THAN  
**70%**  
CONTRAST

Taralay  
Multilayered



0720 Beige Clair / Brun  
**81.3%**  
CONTRAST



0722 Gris Clair / Carbone  
**75.9%**  
CONTRAST



0714 Gris / Noir  
**75.6%**  
CONTRAST



0723 Carbone / Gris Clair  
**73.3%**  
CONTRAST



0724 Carbone / Bamboo  
**73.7%**  
CONTRAST

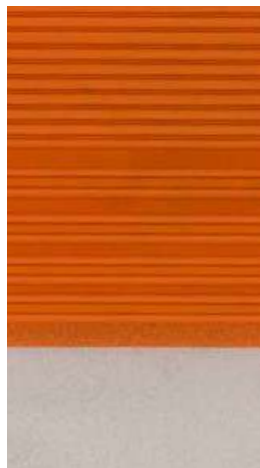

0718 Ivoire / Mandarine  
**70.3%**  
CONTRAST



0717 Ivoire / Vermillon  
**71.5%**  
CONTRAST



0716 Ivoire / Indigo  
**80.7%**  
CONTRAST





“my  
Reference,”

..... PAGES .....

**100/175**

.....







## LUXURY VINYL TILE

### Creation 70 ..... 106-123

- Creation 70 ..... 112-119
- Creation 70 Clic ..... 112-119
- Creation 70 Looselay ..... 112-119
- Creation 70 Connect ..... 122

### Saga<sup>2</sup> ..... 124-127

### Creation 55 ..... 128-145

- Creation 55 ..... 136-143
- Creation 55 Clic ..... 136-143
- Creation 55 Looselay ..... 136-143
- Creation 55 Looselay Acoustic ..... 136-143

### Rigid 55 Lock Acoustic ..... 146-151

### Creation 30 ..... 152-165

- Creation 30 ..... 156-163
- Creation 30 Clic ..... 156-163

### Rigid 30 Lock ..... 166-169

### TopSilence Design ..... 170-173

### More than a floor... wall & finishes ..... 174

# CREATION - LVT

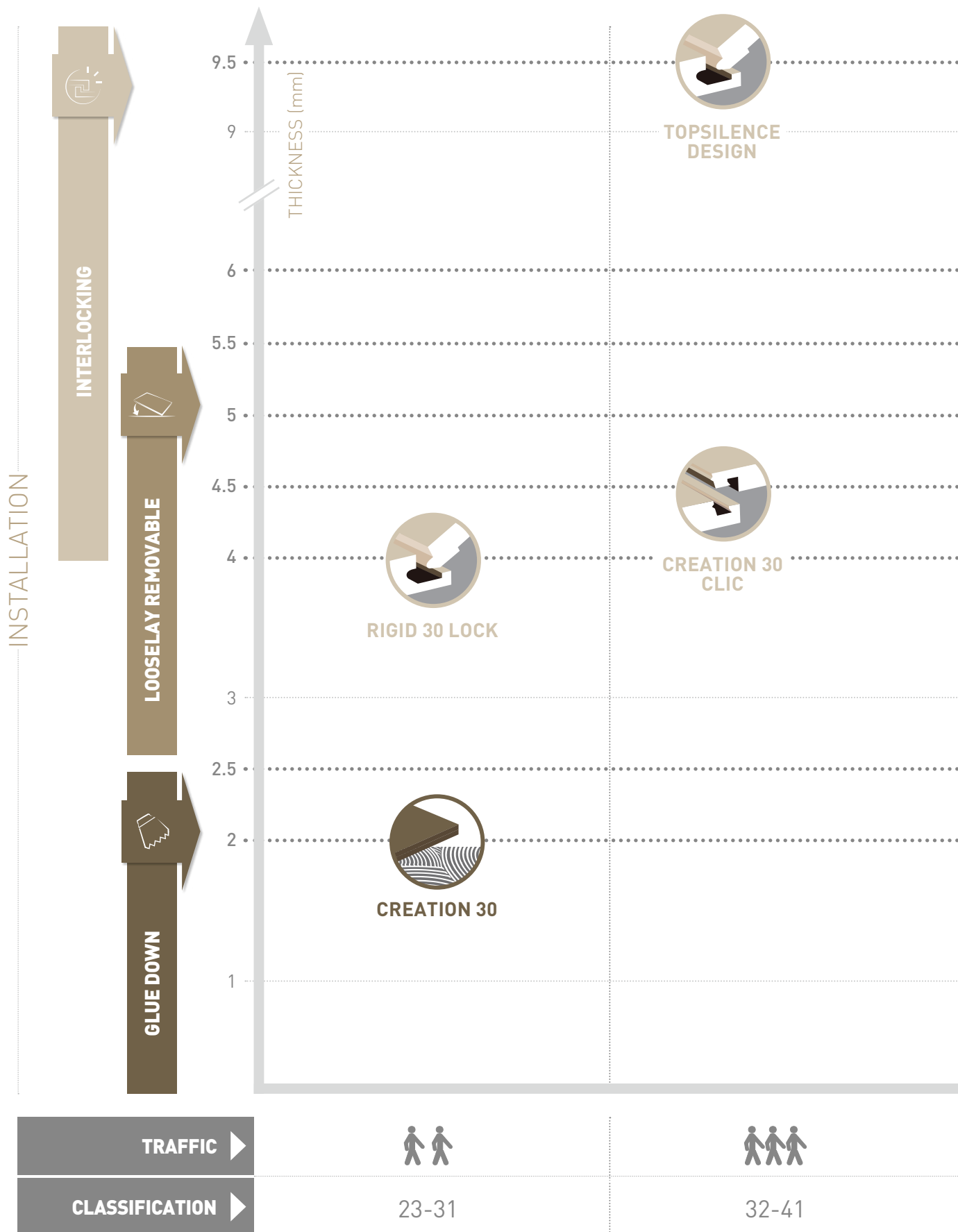

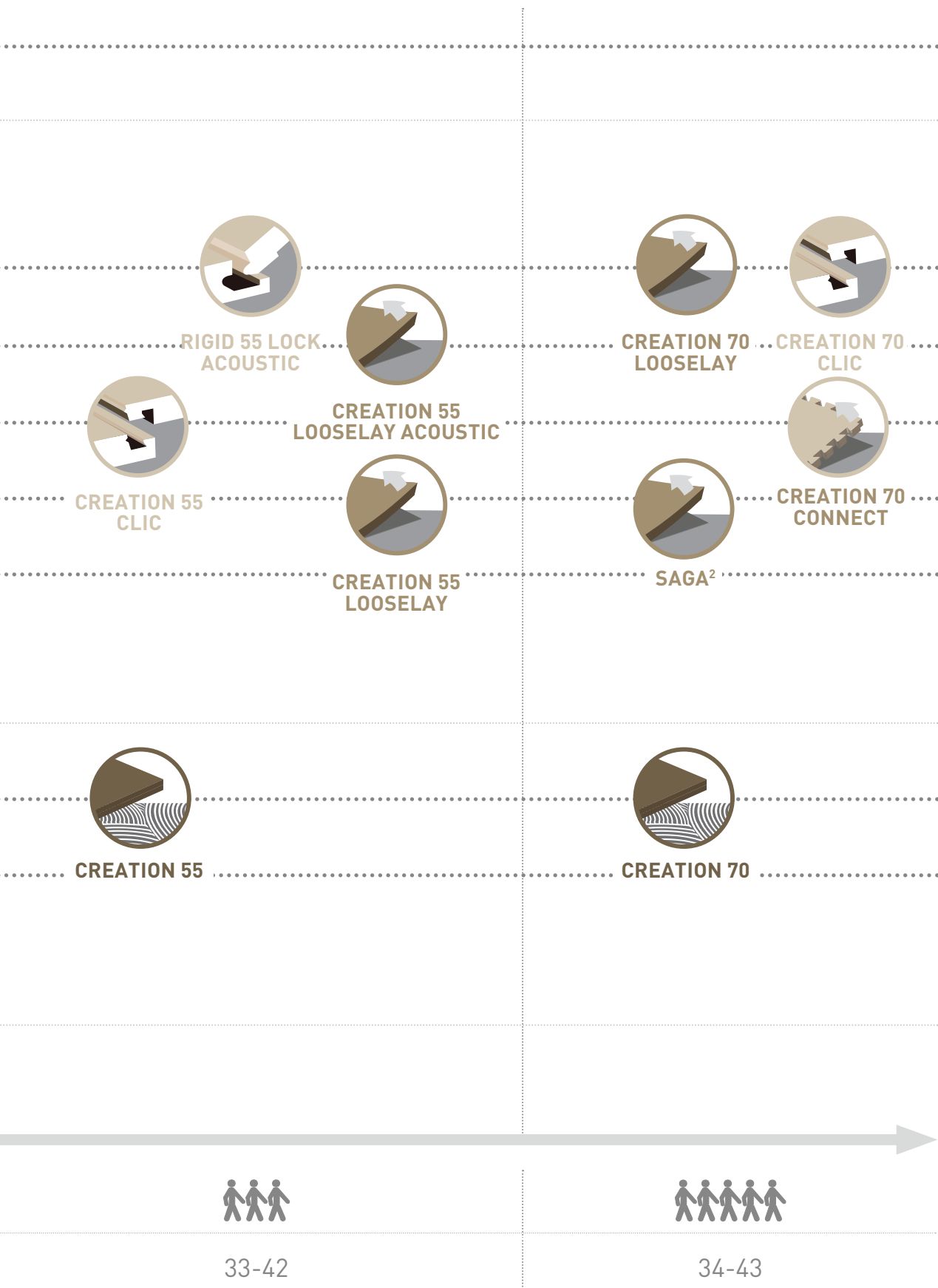

33-42



34-43



# GERFLOR CLIC REVOLUTION



**PUR+ MATT**

**4D DESIGN**

**DUO CORE TECHNOLOGY**

**CLIC REVOLUTION**  
100% VERTICAL

## PUR+ MATT

NEW **MATT** SURFACE TREATMENT FOR AN INCREASED **DURABILITY**

### Matt surface

Natural look, less shiny



### Easy maintenance

Stain & scratch resistance



## 4D DESIGN

GERFLOR DESIGN INNOVATION IN **4 DIMENSIONS**

### 1 Matt surface

Natural look



### 2 Cristal wear layer

High definition design & color



### 3 Structured emboss & four bevelled edges

Ultra realistic surface

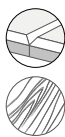

**4**

### 2m pattern design

Less repetition, more realistic



# DUO CORE TECHNOLOGY

A UNIQUE TECHNOLOGY COMBINING  
**COMFORT & STABILITY**

## 1 COMFORT

### Resilient comfort core

Soft & Warm  
Noise absorption

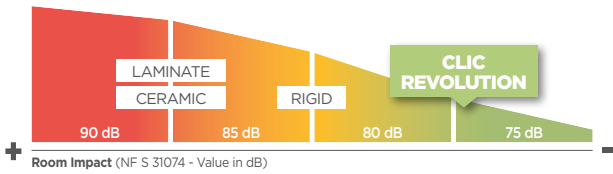

## 2 STABILITY

### Rigid core reinforced by a glass veil

Free adhesive installation  
Direct installation on ceramic  
if joint < 4 mm



Creation  
LVT

# CLIC REVOLUTION

EASY TO INSTALL WITH 100% VERTICAL CLIC

PATENTED



**30% Faster**

## Waterproof joints

## Easy to change a plank

## Heavy load resistance

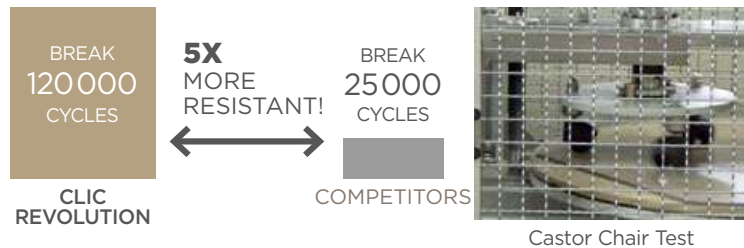

## Durable clic system

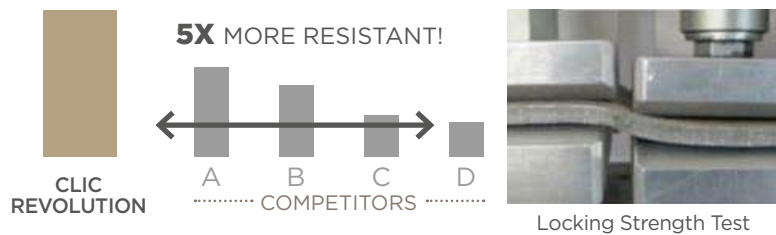

# LUXURY VINYL TILE

## CREATION 70

### ▶ CREATION 70

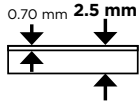

**PUR+ MATT**

Easy maintenance

**4D DESIGN**

**MATT SURFACE**

Natural look

**CRISTAL WEAR LAYER**

High definition design & color

**STRUCTURED EMOSS & BEVEL**

Ultra realistic surface

**DESIGNS**

Wide variety of planks or tiles

**RESILIENT COMFORT CORE**

Noise absorption

Soft underfoot

**DIAMOND BACKLAYER**

**BODY & STRENGTH**

Easy handling

**BACK EMOSS**

Better subfloor adhesion

Easy positioning

Please refer to Gerflor's installation guidelines



More details on [gerflor.com](http://gerflor.com)



# CREATION 70

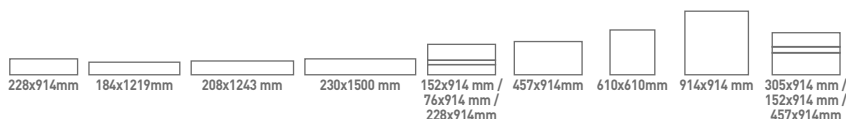
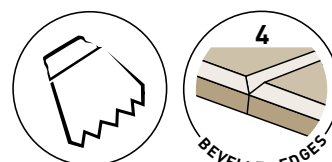

PUR+ Matt 100% recyclable

## CREATION 70 DESIGN

**CREATION 70 DESIGN** is a synthetic, decorative, flexible, antistatic abrasion group T floorcovering available in tile or plank, with beveled edges. It consists in a 0.70 mm thick transparent wear layer, a design film and a Resilient Comfort Core to provide softness and comfort surface. The overall thickness is 2.5 mm. It benefits from a cross-linked polyurethane surface treatment (PUR+ MATT), making maintenance easier and eliminating the need for initial polishes.

**CREATION 70 DESIGN** is a glued floorcovering, resistant to use (commercial / industrial use) of 34-43 according to EN-ISO 10874 and has Bfl-s1 class for smoke emission according to EN 13501-1.

**CREATION 70 DESIGN** is made with phthalate free plasticizers, except recycled content. It is 100% recyclable and made with 35% of recycled content. It is REACH compliant. The product emission rate of organic compounds is < 10 microgram/m<sup>3</sup> (TVOC < 28 days - ISO 16000-6).

Creation  
LVT

		CREATION 70										
		CREATION 70 DESIGN									CREATION 70	
DESCRIPTION												
Total thickness	EN ISO 24346	mm	2.50									2.50
Thickness of wearlayer	EN ISO 24340	mm	0.70									0.70
Weight	EN ISO 23997	g/sqm	4100									3960
Size	EN ISO 24342	mm	184x1219	230x1500	Mix planks 76/152/228 x914	610x610	914x914	457x914	228x914	Mix tiles 152/305/457 x914	208x1243	
Number of planks / tiles and sqm per box	-	-	14 <sup>(1)</sup> / 15 3.14 / 3.36	9 / 3.11	8+8+8 / 3.34 m	9 / 3.35	5 / 4.18	9 / 3.76	17 / 3.54	4+4+4 / 3.34	14 / 3.62	
CLASSIFICATION												
Norm / Product specification	-	-	EN ISO 10582									EN ISO 10582
European classification	EN ISO 10874	class	34-43									34-43
Fire rating	EN 13501-1	class	Bfl-s1									Bfl-s1
Static electrical propensity	EN 1815	kV	< 2									< 2
Slip resistance wet <sup>(2)</sup>	DIN 51 130	class	R10									R10
PERFORMANCES												
Wear resistance	EN 660.2	mm <sup>3</sup>	≤ 2.0									≤ 2.0
Wear group	-	group	T									T
Type Binder content	ISO 10582	type	I									I
Room impact	NF S 31074	dB	76									76
Sound Insulation	EN ISO 717-2	dB	4									4
Dimensional stability (norm)	EN ISO 23999	%	≤ 0.25									≤ 0.25
Dimensional stability (average measured value)	-	%	≤ 0.10									≤ 0.10
Residual indentation	EN ISO 24343-1	mm	≤ 0.10									≤ 0.10
Castor chair test (type H)	ISO 4918	-	OK									OK
Thermal conductivity	EN ISO 10456	W/(m.k)	0.25									0.25
Colour fastness	EN 20 105 - B02	degree	> 6									> 6
Surface treatment	-	-	PUR+ Matt									PUR+ Matt
Chemical products resistance	EN ISO 26987	-	OK									OK
ENVIRONMENT / INDOOR AIR QUALITY												
TVOC after 28 days	ISO 16000-6	microgram/m <sup>3</sup>	< 10									< 10
Certification	-	-	Floorscore®									Floorscore®
CE MARKING												
CE		EN 14041										









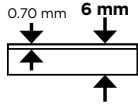

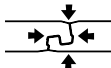

[1] Regimental Picadilly 0807  
[2] Ramp test with oil

# LUXURY VINYL TILE

## CREATION 70 CLIC

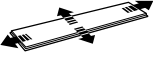
### ▶ CREATION 70 CLIC



PUR+ MATT	4D DESIGN	DUO CORE TECHNOLOGY	CLIC REVOLUTION 100% VERTICAL
 <p>Easy maintenance</p>	<p><b>MATT SURFACE</b></p>  <p>Natural look</p>	<p><b>1 RESILIENT COMFORT CORE</b></p>  <p>Noise absorption</p>  <p>Soft underfoot</p>	<p><b>FAST RENOVATION</b></p> <p>30% Faster</p>  <p>Durable clic system</p>  <p>Heavy load resistance</p>  <p>Waterproof joints</p>  <p>Easy to change a plank</p>
	<p><b>CRISTAL WEAR LAYER</b></p>  <p>High definition design &amp; color</p>	<p><b>2 RIGID CORE WITH FIBER GLASS VEIL</b></p>  <p>The best stability</p>  <p>No adhesive</p>  <p>Renovation ceramic 4 mm joint</p>	
	<p><b>STRUCTURED EMBOSS &amp; BEVEL</b></p>   <p>Ultra realistic surface</p>		
	<p><b>2M PATTERN DESIGN</b></p> <p>Wide variety of planks or tiles</p>		

 **UNDERLAY GERFLOR ACOUSTIC / 15 dB**



**ROMUS TOOLS**  
Anti-bounce mallet - Fitter Knife - LVT Roller



Please refer to Gerflor's installation guidelines

Format: 1 m x 15 lm  
Ref.: 1798

More details on [gerflor.com](http://gerflor.com)

# CREATION 70 CLIC

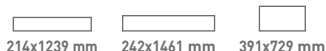
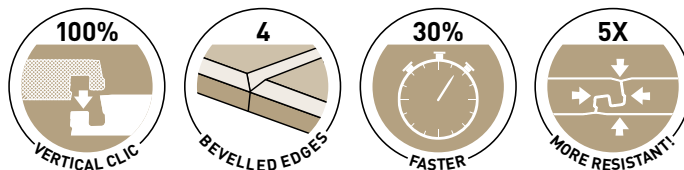

PUR+ Matt 100% recyclable

**CREATION 70 CLIC** is a synthetic, decorative, flexible, antistatic, abrasion group T floorcovering available in tiles and planks, with bevelled edges. It consists in a 0.70 mm thick transparent wear layer, a design film of 2 m width to have more variety in the design and a Duo Core Technology, made with a rigid core back layer reinforced with a fiber veil, combined with a flexible core top layer to provide softness and comfort surface. The overall thickness is 6 mm.

They benefit from a cross-linked polyurethane surface treatment (**PUR+ MATT**), making maintenance easier and eliminating the need for initial polishes.

**CREATION 70 CLIC** is an interlocking floorcovering assembled with a vertical system on the long and short side for a quick and solid installation. The resistance to use (commercial / industrial use) of 34-43 according to EN-ISO 10874 and has Bfl-s1 class for smoke emission according to EN 13501-1.

**CREATION 70 CLIC** is made with phthalate free plasticizers, except recycled content. It is 100% recyclable and made with 55% of recycled content. It is REACH compliant. The product emission rate of organic compounds is < 10 microgram/m<sup>3</sup> (TVOC < 28 days - ISO 16000-6).

Creation  
LVT

## CREATION 70 CLIC

DESCRIPTION			
Total thickness	EN ISO 24346	mm	6
Thickness of wearlayer	EN ISO 24340	mm	0.70
Weight	EN ISO 23997	g/sqm	9850
Size	EN ISO 24342	mm	214 x 1239    242 x 1461    391 x 729
Number of planks /tiles and sqm per box	-	-	6 / 1.59    5 / 1.77    5 / 1.43
CLASSIFICATION			
Norm / Product specification	-	-	EN ISO 10582
European classification	EN ISO 10874	class	34-43
Fire rating	EN 13501-1	class	Bfl-s1
Static electrical propensity	EN 1815	kV	< 2
Slip resistance wet: ramp test with oil	DIN 51 130	class	R10
PERFORMANCES			
Wear resistance	EN 660.2	mm <sup>3</sup>	≤ 2.0
Wear group	-	group	T
Type Binder content	ISO 10582	type	I
Dimensional stability (norm)	EN ISO 23999	%	≤ 0.15
Dimensional stability (average measured value)	-	%	≤ 0.05
Residual indentation	EN ISO 24343-1	mm	≤ 0.10
Impact sound insulation	EN ISO 717-2	dB	4
Room impact	NF S 31074	dB	78
Castor chair test (type H)	ISO 4918	-	OK
Thermal conductivity	EN ISO 10456	W/(m.k)	0.25
Colour fastness	EN 20 105 - B02	degree	≥ 6
Surface treatment	-	-	PUR+ Matt
Chemical products resistance	EN ISO 26987	-	OK
ENVIRONMENT / INDOOR AIR QUALITY			
TVOC after 28 days	ISO 16000-6	microgram/m <sup>3</sup>	< 10
Certification	-	-	Floorscore®
CE MARKING			
	EN 14041		



# LUXURY VINYL TILE

## CREATION 70 LOOSELAY

### ▶ CREATION 70 LOOSELAY

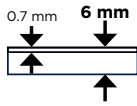

<b>PUR+ MATT</b>	<b>4D DESIGN</b>	<b>DUO CORE TECHNOLOGY</b>	<b>GRIP-WAVE BACKLAYER</b>
<p>Easy maintenance</p>	<b>MATT SURFACE</b> <p>Natural look</p>	<b>1 RESILIENT COMFORT CORE</b> <p>Noise absorption</p> <p>Soft underfoot</p>	<b>ANTI-SKID BACKING</b> <p>Super strong suction to the subfloor</p> <p>Air circulation: better acoustic</p> <p>Humidity circulation: moisture resistance</p>
	<b>CRISTAL WEAR LAYER</b> <p>High definition design &amp; color</p>	<b>2 RIGID CORE</b> <p>The best stability / Fiber glass inside</p> <p>Renovation ceramic &lt; 5 mm joint</p>	<p>Easily removable: renovation</p>
	<b>STRUCTURED EMBOSS &amp; BEVEL</b> <p>Ultra realistic surface</p>		
	<b>MIX&amp;MATCH DESIGNS</b> <p>Easy mix&amp;match of designs &amp; formats</p>		

#### QUICK & EASY TO INSTALL

Please refer to Gerflor's installation guidelines



Installation with tackifier



Apply planks or tiles



Pressure roller



Easy to replace a plank

# CREATION 70 LOOSELAY

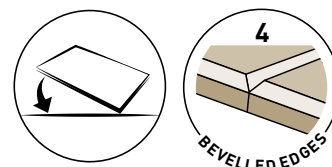

PUR+ Matt 100% recyclable

**CREATION 70 LOOSELAY** is a synthetic, decorative, flexible, antistatic, abrasion group T floorcovering available in tiles and planks, with bevelled edges. It consists in a 0.70 mm thick transparent wear layer, a design film and a Duo Core Technology, made with a rigid core back layer reinforced with a fiber veil, combined with a flexible core top layer to provide softness and comfort surface. The overall thickness is 6 mm. It also includes anti-skid backing to allow an easy installation.

It benefits from a cross-linked polyurethane surface treatment (**PUR+ MATT**), making maintenance easier and eliminating the need for initial polishes.

**CREATION 70 LOOSELAY** is a loose lay floorcovering, resistant to use (commercial / industrial use) of 34-43 according to EN-ISO 10874 and has Bfl-s1 class for smoke emission according to EN 13501-1.

**CREATION 70 LOOSELAY** is made with phthalate free plasticizers, except recycled content. It is 100% recyclable and made with 35% of recycled content. It is REACH compliant. The product emission rate of organic compounds is < 10 microgram/m<sup>3</sup> (TVOC < 28 days – ISO 16000-6).

## EXPLORE THE WORLD OF POSSIBILITIES

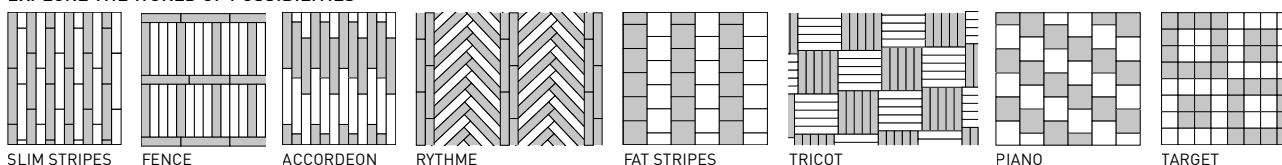

## CREATION 70 LOOSELAY

DESCRIPTION			
Total thickness	EN ISO 24346	mm	6.00
Thickness of wear layer	EN ISO 24340	mm	0.70
Weight	EN ISO 23997	g/sqm	10000
Size	EN ISO 24342	mm	229 x 1220    600 x 600    914 x 914
Number of planks / tiles and sqm per box	-	-	6 / 1.68    4 / 1.44    2 / 1.67
CLASSIFICATION			
Norm / Product specification	-	-	EN ISO 10582
European classification	EN ISO 10874	class	34-43
Fire rating	EN 13501-1	class	Bfl-s1
Static electrical propensity	EN 1815	kV	< 2
Slip resistance wet: ramp test with oil	DIN 51 130	class	R10
PERFORMANCES			
Wear resistance	EN 660.2	mm <sup>3</sup>	≤ 2.0
Wear group	-	group	T
Type Binder content	ISO 10582	type	I
Room impact	NF S 31074	dB	73
Impact sound insulation	EN ISO 717-2	dB	9
Dimensional stability (norm)	EN ISO 23999	%	≤ 0.15
Dimensional stability (average measured value)	-	%	≤ 0.05
Residual indentation	EN ISO 24343-1	mm	≤ 0.10
Castor chair test (type H)	ISO 4918	-	OK
Thermal conductivity	EN ISO 10456	W/(m.k)	0.25
Colour fastness	EN 20 105 - B02	degree	≥ 6
Surface treatment	-	-	PUR+ Matt
Chemical products resistance	EN ISO 26987	-	OK
ENVIRONMENT / INDOOR AIR QUALITY			
TVOC after 28 days	ISO 16000-6	microgram/m <sup>3</sup>	< 10
CE MARKING			
CE	EN 14041		

# LUXURY VINYL TILE

-  | CREATION 70 /
-  | CREATION 70 CLIC /
-  | CREATION 70 LOOSELAY

PUR+ Matt  100% recyclable



1189 Travertino Grey

 228 x 914



1051 Muse Smocked

 208 x 1243 |  214 x 1239

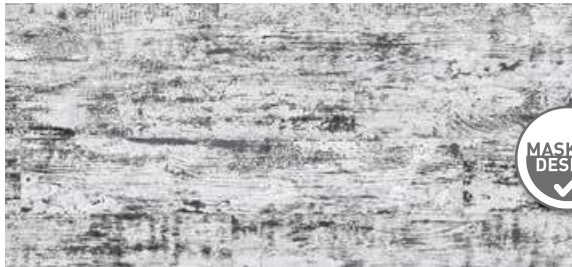

1050 Grace Bay Black

 208 x 1243 |  214 x 1239



0359 Wild Oak

 208 x 1243 |  214 x 1239



1187 Cervino Oak Cold Grey

 230 x 1500



0800 Toasted Wood Roadster

 230 x 1500 |  242 x 1461



1056 Onka Pearl

 230 x 1500 |  242 x 1461



0799 Toasted Wood Cafe

 230 x 1500 |  242 x 1461





1053 Toasted Wood Ash

 230 x 1500 |  242 x 1461



1057 Onka Coffee

 230 x 1500 |  242 x 1461





GLUE DOWN



INTERLOCKING



LOOSELAY  
REMOVABLE



1055 Onka Natural

230 x 1500 | 242 x 1461



1052 Muse Sand

208 x 1243 | 214 x 1239



1054 Onka Honey

230 x 1500 | 242 x 1461 | 229 x 1220



1190 Clifton Honey

208 x 1243



0545 Serena

208 x 1243 | 214 x 1239



0577 Albion

208 x 1243 | 214 x 1239



1075 Diesel Nala

230 x 1500 | 229 x 1220



1191 Clifton Chestnut

MIX: 152 x 914 / 76 x 914 / 228 x 914



1074 Diesel Burnt

230 x 1500 | 229 x 1220



0360 Deep Forest

208 x 1243 | 214 x 1239



DESIGN SHADE VARIATION:



Light



Medium



High

# LUXURY VINYL TILE

-  | CREATION 70 /
-  | CREATION 70 CLIC /
-  | CREATION 70 LOOSELAY

PUR+ Matt  100% recyclable



1192 Clifton Grey  208 x 1243



1188 Travertino Beige  228 x 914



1049 Grace Bay Cream  208 x 1243 |  214 x 1239





0356 Denim Wood  208 x 1243 |  229 x 1220



0803 Solid Glam Picadilly  184 x 1219



0357 Portobello  208 x 1243 |  214 x 1239 |  229 x 1220



0807 Regimental Picadilly  184 x 1219



0358 Moon Island  208 x 1243 |  214 x 1239 |  229 x 1220



0803 Solid Glam Picadilly  
0807 Regimental Picadilly



GLUE DOWN



INTERLOCKING



LOOSELAY  
REMOVABLE



0324 Silversands

208 x 1243



0329 Lined Oak

208 x 1243



0538 Midwest

208 x 1243 | 214 x 1239 | 229 x 1220



0797 Cervino Oak Beige

230 x 1500 | 242 x 1461



0556 Clifton

MIX: 152 x 914 / 76 x 914 / 228 x 914



0798 Cervino Oak Nature

230 x 1500 | 242 x 1461



0535 Douglas

208 x 1243



1186 Cervino Oak Honey Clear

230 x 1500



DESIGN SHADE VARIATION:



Light



Medium



High





# LUXURY VINYL TILE

-  | CREATION 70 /
-  | CREATION 70 CLIC /
-  | CREATION 70 LOOSELAY

PUR+ Matt  100% recyclable



1068 Etna Beige  457 x 914  
MIX: 152 x 914 / 305 x 914 / 457 x 914 |  391 x 729



0087 Dock Taupe  457 x 914 |  391 x 729 |  914 x 914



1063 Pure Concrete Beige  914 x 914 |  391 x 729



1083 Gentleman Taupe  228 x 914 |  229 x 1220



1077 Tatami Savane  610 x 610 |  600 x 600



1079 Tatami Smoked  610 x 610 |  600 x 600



1078 Tatami Raffia  610 x 610 |  600 x 600



1065 Prado Terracotta  457 x 914 |  391 x 729



0088 Oxyd Pure  457 x 914 |  391 x 729



1076 Gentleman Tweed  228 x 914 |  229 x 1220





GLUE DOWN



INTERLOCKING



LOOSELAY  
REMOVABLE



1060 Pure  
Concrete Light

914 x 914 | 391 x 729 | 914 x 914



1059 Secret Garden White

457 x 914 | 391 x 729



1061 Pure  
Concrete Medium

914 x 914 | 391 x 729 | 914 x 914



0522 East Village

610 x 610



0085 Dock Grey

457 x 914 | 391 x 729 | 914 x 914



0531 Halifax

610 x 610



0561 Carassi

228 x 914



1069 Etna Dark

457 x 914 | 391 x 729



0089 Oxyd Iron

457 x 914 | 391 x 729

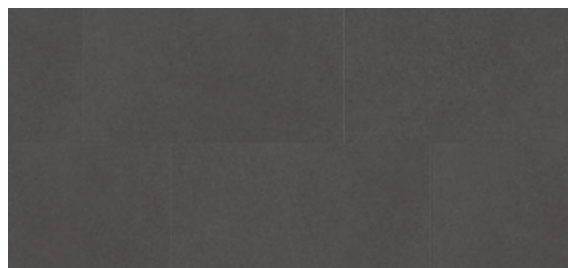

1062 Pure  
Concrete Dark

914 x 914 | 391 x 729 | 914 x 914



DESIGN SHADE VARIATION:



Light



Medium



High

# LUXURY VINYL TILE

-  | CREATION 70 /
-  | CREATION 70 CLIC /
-  | CREATION 70 LOOSELAY

PUR+ Matt

 100% recyclable

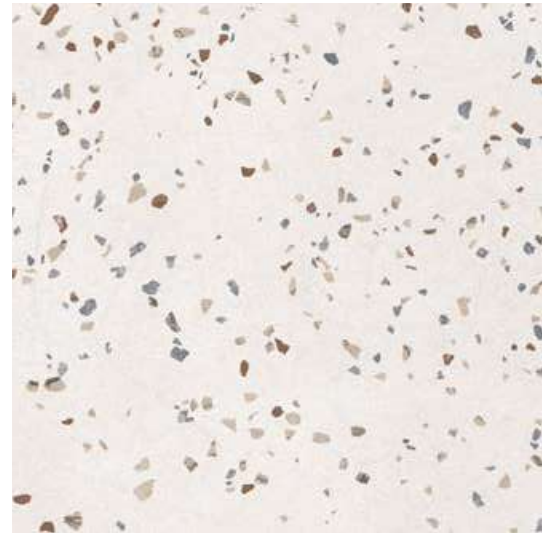

1067 Terrazzo Nature\*

 914 x 914 |  391 x 729



1066 Terrazzo Ocre\*

 914 x 914 |  391 x 729

\*Scale: 1/5

1067 Terrazzo Nature

118

DESIGN SHADE VARIATION:



Light



Medium



High





GLUE DOWN



INTERLOCKING



LOOSELAY  
REMOVABLE



1058 Gentleman Grey /  
1080 Gentleman Garance /  
1082 Gentleman Peppermint



1080 Gentleman Garance

610 x 610

600 x 600



1081 Gentleman Indigo

610 x 610

600 x 600



1082 Gentleman Peppermint

610 x 610

600 x 600



1058 Gentleman  
Grey

610 x 610

391 x 729

600 x 600



1064 Prado Green

457 x 914

391 x 729

Creation  
LVT

# LUXURY VINYL TILE

## CREATION 70 CONNECT

### ▶ CREATION 70 CONNECT

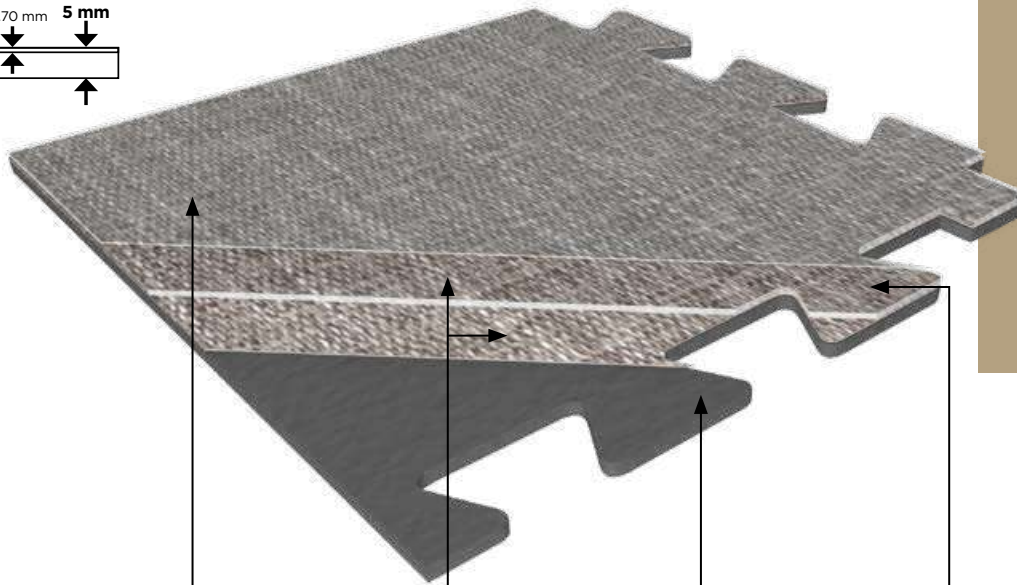
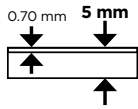

#### PUR+ MATT



Easy maintenance

#### 4D DESIGN

##### MATT SURFACE



Natural look

##### CRISTAL WEAR LAYER



High definition design & color

##### STRUCTURED EMBOSS



Ultra realistic surface

##### DESIGNS

Designs selected to hide dovetails - all over effect

#### RESILIENT REINFORCED CORE



Glass particles for better stability



Noise absorption



Soft underfoot



Renovation ceramic 5 mm joint

#### EXCLUSIVE DOVETAILS



Gerflor patented



No adhesive



Easy installation



Avoid mistakes installation



Resistant dovetails



Interlocking installation with dovetails



Adhesive free



Fast and easy renovation



All over effect

Please refer to Gerflor's installation guidelines

More details on [gerflor.com](http://gerflor.com)

# CREATION 70 CONNECT



Removable

5dB

PUR+ Matt



**CREATION 70 Connect** is a synthetic, decorative, flexible, antistatic, abrasion group T floorcovering available in tiles. It consists in a 0.70 mm thick transparent wear layer, a design film, a calendered layer and a PVC compact sublayer reinforced with fibers. The overall thickness is 5 mm.

It benefits from a cross-linked polyurethane surface treatment (**PUR+ MATT**), making maintenance easier and eliminating the need for initial polishes.

**CREATION 70 Connect** is an interlocking floorcovering, resistant to use (commercial / industrial use of 34-43 according to EN-ISO 10874 and has Bfl-s1 class for smoke emission according to EN 13501-1.

**CREATION 70 Connect** is made with phthalate free plasticizers, except recycled content. It is 100% recyclable and made with 55% of recycled content. It is REACH compliant. The product emission rate of organic compounds is < 10 microgram/m<sup>3</sup> (TVOC < 28 days – ISO 16000-6).

			CREATION 70 CONNECT
<b>DESCRIPTION</b>			
Total thickness	EN ISO 24346	mm	5.00
Thickness of wearlayer	EN ISO 24340	mm	0.70
Weight	EN ISO 23997	g/sqm	8235
Tile size	EN ISO 24342	mm	701.3 x 701.3
Number of tiles and sqm per box	-	-	20 / 9.83
<b>CLASSIFICATION</b>			
Norm / Product specification	-	-	EN ISO 10582
European classification	EN ISO 10874	class	34-43
Fire rating	EN 13501-1	class	Bfl-s1
Static electrical propensity	EN 1815	kV	< 2
Slip resistance wet <sup>(1)</sup>	DIN 51130	class	R10
<b>PERFORMANCES</b>			
Wear resistance	EN 660.2	mm <sup>3</sup>	≤ 2.0
Wear group	-	group	T
Type Binder content	ISO 10582	group	I
Room impact	NF-S 31074	dB	75
Impact sound insulation	EN ISO 717-2	dB	5
Dimensional stability	EN ISO 23999	%	≤ 0.15
Residual indentation	EN ISO 24343-1	mm	≤ 0.10
Castor chair test (type H)	ISO 4918	-	OK
Thermal conductivity	EN ISO 10456	W/(m.k)	0.25
Colour fastness	EN 20 105 - B02	degree	≥ 6
Surface treatment	-	-	PUR+ Matt
Chemical products resistance	EN ISO 26987	-	OK
<b>ENVIRONMENT / INDOOR AIR QUALITY</b>			
TVOC after 28 days	ISO 16000-6	microgram/m <sup>3</sup>	< 10
<b>CE MARKING</b>			
CE	EN 14041		

(1) Ramp test with oil



# LUXURY VINYL TILE

## CREATION 70 CONNECT



701.3x701.3mm

Removable

5 dB

PUR+ Matt



100% recyclable

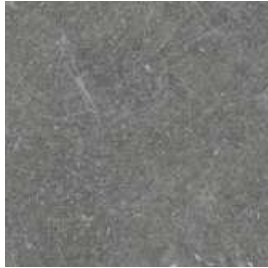

0085 Dock Grey

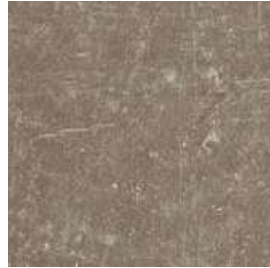

0087 Dock Taupe



0063 Rough Textile Grey



0062 Rough Textile Beige



0089 Gentleman Taupe

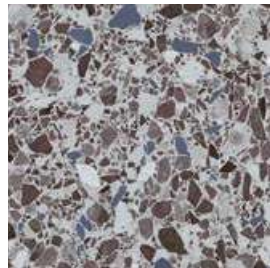

1089 Dalma Burgundy



0088 Gentleman Grey



1088 Dalma Grey

Scale: 1/5

## EXCLUSIVE EMBOSSES FOR ENHANCED DESIGNS

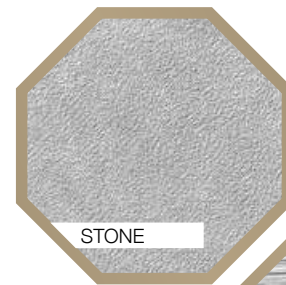

STONE



BRUSHED

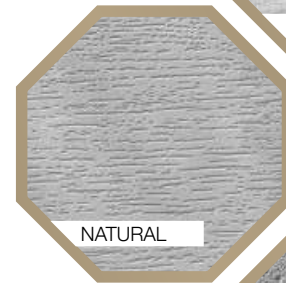

NATURAL



HAMMERED

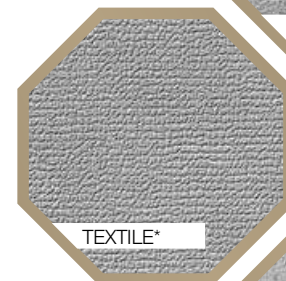

TEXTILE\*

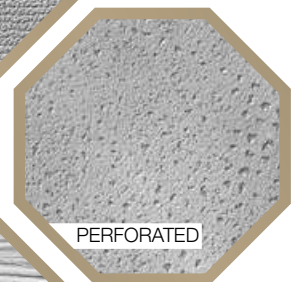

PERFORATED







RIB WOOD



SAW EFFECT



# CROSS REFERENCES

CODE	EMBOSS	CREATION 70					SKIRTINGS (MATCHING DESIGNS)
							
DOCK GREY	0085	HAMMERED	■	■	■	■	S111
DOCK TAUPE	0087	HAMMERED	■	■	■	■	S020
GENTLEMAN GREY	1058	TEXTILE	■	■	■	■	WHITE
MIDWEST	0538	NATURAL	■	■	■	■	S039
MOON ISLAND	0358	BRUSHED	■	■	■	■	S034
ONKA HONEY	1054	NATURAL	■	■	■	■	S121
PORTOBELLO	0357	BRUSHED	■	■	■	■	S053
PURE CONCRETE DARK	1062	HAMMERED	■	■	■	■	WHITE
PURE CONCRETE LIGHT	1060	HAMMERED	■	■	■	■	WHITE
PURE CONCRETE MEDIUM	1061	HAMMERED	■	■	■	■	WHITE
ALBION	0577	NATURAL	■	■	■	■	S108
CERVINO OAK BEIGE	0797	NATURAL	■	■	■	■	S011
CERVINO OAK NATURE	0798	NATURAL	■	■	■	■	S109
DEEP FOREST	0360	BRUSHED	■	■	■	■	S110
ETNA BEIGE	1068	HAMMERED	■	■	■	■	WHITE
ETNA DARK	1069	HAMMERED	■	■	■	■	WHITE
GRACE BAY BLACK	1050	NATURAL	■	■	■	■	WHITE
GRACE BAY CREAM	1049	NATURAL	■	■	■	■	WHITE
MUSE SAND	1052	NATURAL	■	■	■	■	S117
MUSE SMOKED	1051	NATURAL	■	■	■	■	S118
ONKA COFFEE	1057	NATURAL	■	■	■	■	WHITE
ONKA NATURAL	1055	NATURAL	■	■	■	■	S122
ONKA PEARL	1056	NATURAL	■	■	■	■	S120
OXYD IRON	0089	PERFORATED	■	■	■	■	WHITE
OXYD PURE	0088	PERFORATED	■	■	■	■	WHITE
PURE CONCRETE BEIGE	1063	HAMMERED	■	■	■	■	WHITE
PRADO GREEN	1064	STONE	■	■	■	■	WHITE
PRADO TERRACOTTA	1065	STONE	■	■	■	■	WHITE
SECRET GARDEN WHITE	1059	STONE	■	■	■	■	WHITE
SERENA	0545	NATURAL	■	■	■	■	S132
TERRAZZO NATURE	1067	STONE	■	■	■	■	WHITE
TERRAZZO OCRE	1066	STONE	■	■	■	■	WHITE
TOASTED WOOD ASH	1053	NATURAL	■	■	■	■	WHITE
TOASTED WOOD CAFE	0799	NATURAL	■	■	■	■	WHITE
TOASTED WOOD ROADSTER	0800	NATURAL	■	■	■	■	WHITE
WILD OAK	0359	BRUSHED	■	■	■	■	S075
DENIM WOOD	0356	NATURAL	■	■	■	■	S026
DIESEL BURNT	1074	NATURAL	■	■	■	■	WHITE
DIESEL NALA	1075	NATURAL	■	■	■	■	WHITE
GENTLEMAN GARANCE	1080	TEXTILE	■	■	■	■	WHITE
GENTLEMAN INDIGO	1081	TEXTILE	■	■	■	■	WHITE
GENTLEMAN PEPPERMINT	1082	TEXTILE	■	■	■	■	WHITE
GENTLEMAN TAUPE	1083	TEXTILE	■	■	■	■	WHITE
GENTLEMAN TWEED	1076	TEXTILE	■	■	■	■	WHITE
TATAMI SAVANE	1077	STONE	■	■	■	■	WHITE
TATAMI SMOKED	1079	STONE	■	■	■	■	WHITE
TATAMI RAFFIA	1078	STONE	■	■	■	■	WHITE
CARASSI	0561	RIB WOOD	■	■	■	■	WHITE
CERVINO OAK COLD GREY	1187	NATURAL	■	■	■	■	WHITE
CERVINO OAK HONEY CLEAR	1186	NATURAL	■	■	■	■	WHITE
CLIFTON	0556	NATURAL	■	■	■	■	S144
CLIFTON CHESNUT	1191	NATURAL	■	■	■	■	WHITE
CLIFTON GREY	1192	NATURAL	■	■	■	■	WHITE
CLIFTON HONEY	1190	NATURAL	■	■	■	■	WHITE
DOUGLAS	0535	NATURAL	■	■	■	■	WHITE
EAST VILLAGE	0522	STONE	■	■	■	■	S154
HALIFAX	0531	STONE	■	■	■	■	S032
LIMED OAK	0329	NATURAL	■	■	■	■	S147
REGIMENTAL PICADILLY	0807	NATURAL	■	■	■	■	WHITE
SILVERSANDS	0324	NATURAL	■	■	■	■	S146
SOLID GLAM PICADILLY	0803	NATURAL	■	■	■	■	WHITE
TRAVERTINO BEIGE	1188	STONE	■	■	■	■	WHITE
TRAVERTINO GREY	1189	STONE	■	■	■	■	WHITE
DALMA BURGUNDY	1089	HAMMERED	■	■	■	■	WHITE
DALMA GREY	1088	HAMMERED	■	■	■	■	WHITE
ROUGH TEXTILE BEIGE	0062	TEXTILE	■	■	■	■	WHITE
ROUGH TEXTILE GREY	0063	TEXTILE	■	■	■	■	WHITE

■ : Available  
WHITE: S001

## PACKAGING

Product size (mm)	m <sup>2</sup> / box	m <sup>2</sup> / palette
-------------------	----------------------	--------------------------

### CREATION 70

184 x 1219	3.36	215.32
184 x 1219*	3.14	213.53
208 x 1243	3.62	195.46
228 x 914	3.54	212.65
230 x 1500	3.11	204.93
457 x 914	3.76	203.09
610 x 610	3.35	187.54
914 x 914	4.18	204.84
MIX Planks	3.34	213.49
MIX Tiles	3.34	200.58

### CREATION 70 CLIC

214 x 1239	1.59	85.86
242 x 1461	1.77	84.96
391 x 729	1.43	85.80

### CREATION 70 LOOSELAY

229 x 1220	1.67	80.2
600 x 600	1.44	72.0
914 x 914	1.67	80.2

### CREATION 70 CONNECT

701 x 701	-	49.14
-----------	---	-------

\* Regimental Picadilly 0807

# LUXURY VINYL TILE

## SAGA<sup>2</sup>

### ▶ SAGA<sup>2</sup>

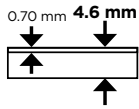

#### PROTECSOL<sup>®</sup>



Easy maintenance

#### 4D DESIGN

##### MATT SURFACE



Natural look

##### CRISTAL WEAR LAYER



High definition design & color

##### STRUCTURED EMBOSS



Ultra realistic surface

##### DESIGNS

Exclusive designs

#### RESILIENT CORE



Noise absorption



Soft underfoot



Renovation ceramic  
5 mm joint

#### CORK BACKING



15 dB  
Impact Sound  
Insulation



Environmental  
friendly



Easily removable



Installation  
with tackyfier



Comfort &  
Resistance



Acoustic



90° installation

Please refer to Gerflor's installation guidelines

More details on [gerflor.com](http://gerflor.com)



# SAGA<sup>2</sup>



Removable

15 dB

Protocolsol<sup>®</sup>



**SAGA<sup>2</sup>** is a synthetic, decorative, flexible, antistatic, abrasion group T floorcovering available in tiles. It consists in a 0.70 mm thick transparent wear layer, a design film, a calendered layer and a PVC/Cork sublayer which provides acoustic properties with 15 dB impact sound insulation and a walking noise < 65 dB. The overall thickness is 4.6 mm.

It benefits from a **Protocolsol<sup>®</sup>** surface treatment, making maintenance easier and eliminating the need for initial polishes.

**SAGA<sup>2</sup>** is a looselay floorcovering, resistant to use (commercial / industrial use) of 34-43 according to EN-ISO 10874 and has Bfl-s1 class for smoke emission according to EN 13501-1.

**SAGA<sup>2</sup>** is made with phthalate free plasticizers, except recycled content. It is 100% recyclable and made with 55% of recycled content. It is REACH compliant. The product emission rate of organic compounds is < 10 microgram/m<sup>3</sup> (TVOC < 28 days – ISO 16000-6).

			SAGA <sup>2</sup>
<b>DESCRIPTION</b>			
Total thickness	EN ISO 24346	mm	4.6
Thickness of wearlayer	EN ISO 24340	mm	0.70
Weight	EN ISO 23997	g/sqm	5595
Tile size	EN ISO 24342	mm	500 x 500
Number of tiles and sqm per box	-	-	10 / 2.50
<b>CLASSIFICATION</b>			
Norm / Product specification	-	-	EN 652
European classification	EN ISO 10874	class	34-42
Fire rating	EN 13501-1	class	Bfl-s1
Static electrical propensity	EN 1815	kV	< 2
Slip resistance wet <sup>(1)</sup>	DIN 51130	class	R10
<b>PERFORMANCES</b>			
Wear resistance	EN 660.2	mm <sup>3</sup>	≤ 2.0
Wear group	-	group	T
Dimensional stability	EN ISO 23999	%	≤ 0.15
Residual indentation	EN ISO 24343-1	mm	< 0.13
Castor chair test (type H)	ISO 4918	-	OK
Impact sound insulation	EN ISO 717-2	dB	15
Room impact	NF-S 31074	dB	< 65
Thermal conductivity	EN ISO 10456	W/(m.k)	0.25
Colour fastness	EN 20 105 - B02	degree	≥ 6
Surface treatment	-	-	Protocolsol <sup>®</sup>
Chemical products resistance	EN ISO 26987	-	OK
<b>ENVIRONMENT / INDOOR AIR QUALITY</b>			
TVOC after 28 days	ISO 16000-6	microgram/m <sup>3</sup>	< 10
Certification	-	-	Floorscore <sup>®</sup>
<b>CE MARKING</b>			
	EN 14041		

(1) Ramp test with oil

# LUXURY VINYL TILE

SAGA<sup>2</sup>



0030 Gentleman Blue



0088 Gentleman Grey



0017 Kadina City



0023 Barma Mystery



0030 Gentleman Blue



0085 Dock Grey

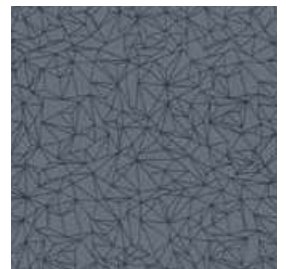

0039 Spider Blue



0027 Fiber  
Heavy Metal

METAL EFFECT



1088 Dalma Grey

Scale: 1/5

# SAGA<sup>2</sup>



Removable

15 dB

Protocolsol®

100% recyclable



0063 Rough Textile Grey



0572 Amarante Dark



0026 Fiber Copper **METAL EFFECT**



0021 Barma Sweet



0089 Gentleman Taupe



0087 Dock Taupe

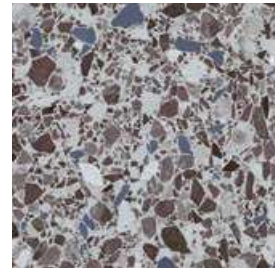

1089 Dalma Burgundy



0028 Fiber Silver **METAL EFFECT**



0062 Rough Textile Beige



0029 Gentleman Beige



0033 Spider Beige

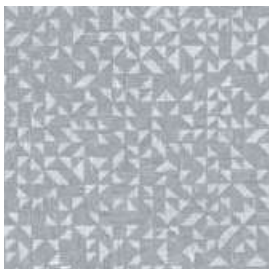

0032 Mozaic Grey



0579 Amarante



0025 Barma Beige



0577 Albion

DESIGN SHADE VARIATION:



Light



Medium



# LUXURY VINYL TILE

## CREATION 55

### ▶ CREATION 55

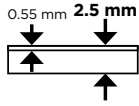

**PUR+ MATT**

Easy maintenance

**4D DESIGN**

**MATT SURFACE**

Natural look

**CRISTAL WEAR LAYER**

High definition design & color

**STRUCTURED EMBOSS & MICRO-BEVEL**

Ultra realistic surface

**MIX&MATCH DESIGNS**

Easy mix&match of designs & formats

**RESILIENT COMFORT CORE**

Noise absorption

Soft underfoot

**DIAMOND BACKLAYER**

**BODY & STRENGTH**

Easy handling

**BACK EMBOSS**

Better subfloor adhesion

Easy positioning

**UNDERLAY**  
GERFLOR SMART FIX / 16 dB



Please refer to Gerflor's installation guidelines



Format: 1 m x 7.5 lm  
Ref.: 1698

More details on [gerflor.com](http://gerflor.com)

# CREATION 55

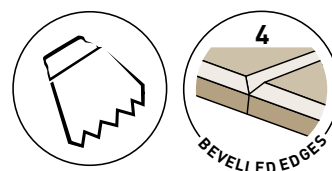

PUR+ Matt | 100% recyclable

**CREATION 55 TREND** is a synthetic, decorative, flexible, antistatic abrasion group T floorcovering available in tile or plank, with beveled edges. It consists in a 0.55 mm thick transparent wear layer, a design film and a Resilient Comfort Core to provide softness and comfort surface. The overall thickness is 2.5 mm.

It benefits from a cross-linked polyurethane surface treatment (PUR+ MATT), making maintenance easier and eliminating the need for initial polishes.

**CREATION 55 TREND** is a glued floorcovering, resistant to use (commercial / industrial use) of 33-42 according to EN-ISO 10874 and has Bfl-s1 class for smoke emission according to EN 13501-1.

**CREATION 55 TREND** is made with phthalate free plasticizers, except recycled content. It is 100% recyclable and made with 35% of recycled content. It is REACH compliant. The product emission rate of organic compounds is < 10 microgram/m<sup>3</sup> (TVOC < 28 days – ISO 16000-6).

Creation  
LVT

## CREATION 55 TREND

DESCRIPTION							
Total thickness	EN ISO 24346	mm	2.50				
Thickness of wearlayer	EN ISO 24340	mm	0.55				
Weight	EN ISO 23997	g/sqm	3850				
Size	EN ISO 24342	mm	184 x 1219	230 x 1500	152 x 762	457 x 914	610 x 610
Number of planks /tiles and sqm per box	-	-	15 / 3.36	9 / 3.11	33 / 3.82	9 / 3.76	9 / 3.35
CLASSIFICATION							
Norm / Product specification	-	-	EN ISO 10582				
European classification	EN ISO 10874	class	33-42				
Fire rating	EN 13501-1	class	B <sub>fl</sub> -s1				
Static electrical propensity	EN 1815	kV	< 2				
Slip resistance wet: ramp test with oil	DIN 51 130	class	R10				
PERFORMANCES							
Wear resistance	EN 660.2	mm <sup>3</sup>	≤ 2.0				
Wear group	-	group	T				
Type Binder content	ISO 10582	type	I				
Room impact	NF S 31074	dB	77				
Impact sound insulation	EN ISO 717-2	dB	4				
Dimensional stability (norm)	EN ISO 23999	%	≤ 0.25				
Dimensional stability (average measured value)	-	%	≤ 0.10				
Residual indentation	EN ISO 24343-1	mm	≤ 0.10				
Castor chair test (type H)	ISO 4918	-	OK				
Thermal conductivity	EN ISO 10456	W/(m.k)	0.25				
Colour fastness	EN 20 105 - B02	degree	≥ 6				
Surface treatment	-	-	PUR+ Matt				
Chemical products resistance	EN ISO 26987	-	OK				
ENVIRONMENT / INDOOR AIR QUALITY							
TVOC after 28 days	ISO 16000-6	microgram/m <sup>3</sup>	< 10				
Certification	-	-	Floorscore®				
CE MARKING							
CE	EN 14041						

# LUXURY VINYL TILE

## CREATION 55 CLIC

### ▶ CREATION 55 CLIC

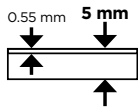

PUR+ MATT	4D DESIGN	DUO CORE TECHNOLOGY	CLIC REVOLUTION 100% VERTICAL
<p>Easy maintenance</p>	<p><b>MATT SURFACE</b></p> <p>Natural look</p>	<p><b>1 RESILIENT COMFORT CORE</b></p> <p>Noise absorption</p> <p>Soft underfoot</p>	<p>30% Faster</p> <p>Durable clic system</p>
	<p><b>CRISTAL WEAR LAYER</b></p> <p>High definition design &amp; color</p>	<p><b>2 RIGID CORE WITH FIBER GLASS VEIL</b></p> <p>The best stability</p> <p>No adhesive</p> <p>Renovation ceramic &lt; 4 mm joint</p>	<p>Heavy load resistance</p> <p>Waterproof joints</p> <p>Easy to change a plank</p>

Please refer to Gerflor's installation guidelines

**UNDERLAY GERFLOR ACOUSTIQUE / 15 dB**



Format: 1 m x 15 lm  
Ref.: 1798

**UNDERLAY GERFLOR SILENCE PLUS / 19 dB**



Format: 1.18 m x 8.5 lm  
Ref.: 5949

**ROMUS TOOLS**  
Anti-bounce mallet - Fitter Knife - LVT Roller



More details on [gerflor.com](http://gerflor.com)



# CREATION 55 CLIC

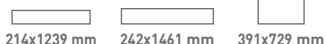
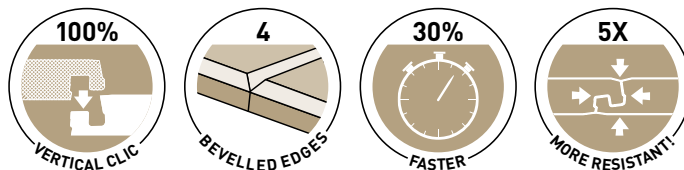

PUR+ Matt



**CREATION 55 CLIC** is a synthetic, decorative, flexible, antistatic, abrasion group T floorcovering available in tiles and planks, with bevelled edges. It consists in a 0.55 mm thick transparent wear layer, a design film of 2 m width to have more variety in the design and a Duo Core Technology, made with a rigid core back layer reinforced with a fiber veil, combined with a flexible core top layer to provide softness and comfort surface. The overall thickness is 5 mm.

It benefits from a cross-linked polyurethane surface treatment (**PUR+ MATT**), making maintenance easier and eliminating the need for initial polishes.

**CREATION 55 CLIC** is an interlocking floorcovering assembled with a vertical system on the long and short side for a quick and solid installation. The resistance to use (commercial / industrial use) of 33-42 according to EN-ISO 10874 and has B<sub>fl</sub>-s1 class for smoke emission according to EN 13501-1.

**CREATION 55 CLIC** is made with phthalate free plasticizers, except recycled content. It is 100% recyclable and made with 55% of recycled content. It is 100% compliant with REACH. The product emission rate of organic compounds is < 10 microgram/m<sup>3</sup> (TVOC < 28 days – ISO 16000-6).

Creation  
LVT

		CREATION 55 CLIC			
<b>DESCRIPTION</b>					
Total thickness	EN ISO 24346	mm	5.00		
Thickness of wearlayer	EN ISO 24340	mm	0.55		
Weight	EN ISO 23997	g/sqm	8230		
Size	EN ISO 24342	mm	214 x 1239	242 x 1461	391 x 729
Number of planks /tiles and sqm per box	EN ISO 24342	mm	7 / 1.86	6 / 2.12	6 / 1.71
<b>CLASSIFICATION</b>					
Norm / Product specification	-	-	EN ISO 10582		
European classification	EN ISO 10874	class	33-42		
Fire rating	EN 13501-1	class	B <sub>fl</sub> -s1		
Static electrical propensity	EN 1815	kV	< 2		
Slip resistance wet: ramp test with oil	DIN 51 130	class	R10		
<b>PERFORMANCES</b>					
Wear resistance	EN 660.2	mm <sup>3</sup>	< 2.0		
Wear group	-	group	T		
Type Binder content	ISO 10582	type	I		
Room impact	NF S 31074	dB	78		
Impact sound insulation	EN ISO 717-2	dB	4		
Dimensional stability (norm)	EN ISO 23999	%	≤ 0.15		
Dimensional stability (average measured value)	-	%	≤ 0.05		
Residual indentation	EN ISO 24343-1	mm	≤ 0.10		
Castor chair test (type H)	ISO 4918	-	OK		
Thermal conductivity	EN ISO 10456	W/(m.k)	0.25		
Colour fastness	EN 20 105 - B02	degree	≥ 6		
Surface treatment	-	-	PUR+ Matt		
Chemical products resistance	EN 423	-	OK		
<b>ENVIRONMENT / INDOOR AIR QUALITY</b>					
TVOC after 28 days	ISO 16000-6	microgram/m <sup>3</sup>	< 10		
Certification	-	-	Floorscore®		
<b>CE MARKING</b>					
CE	EN 14041				

# LUXURY VINYL TILE

## CREATION 55 LOOSELAY

### ▶ CREATION 55 LOOSELAY

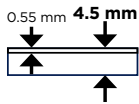

<p><b>PUR+ MATT</b></p> <p>Easy maintenance</p>	<p><b>4D DESIGN</b></p> <p><b>MATT SURFACE</b></p> <p>Natural look</p> <p><b>CRISTAL WEAR LAYER</b></p> <p>High definition design &amp; color</p> <p><b>STRUCTURED EMBOSS</b></p> <p>Ultra realistic surface</p> <p><b>MIX&amp;MATCH DESIGNS</b></p> <p>Easy mix&amp;match of designs &amp; formats</p>	<p><b>DUO CORE TECHNOLOGY</b></p> <p><b>1 RESILIENT COMFORT CORE</b></p> <p>Noise absorption</p> <p>Soft underfoot</p> <p><b>2 RIGID CORE</b></p> <p>The best stability / Fiber glass inside</p> <p>Renovation ceramic &lt; 5 mm joint</p> <p>No adhesive up to 30 m<sup>2</sup></p>	<p><b>GRIP-WAVE BACKLAYER</b></p> <p><b>ANTI-SKID BACKING</b></p> <p>Super strong suction to the subfloor</p> <p>Air circulation: better acoustic</p> <p>Humidity circulation: moisture resistance</p> <p>Easily removable: renovation</p>
---	---	--	--

### QUICK & EASY TO INSTALL

Please refer to Gerflor's installation guidelines



Installation with tackifier



Apply planks or tiles



Pressure roller



Easy to replace a plank

# CREATION 55 LOOSELAY

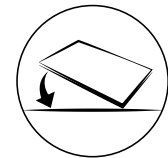

**CREATION 55 LOOSELAY** is a synthetic, decorative, flexible, antistatic, abrasion group T floorcovering available in tiles and planks. It consists in a 0.55 mm thick transparent wear layer, a design film and a Duo Core Technology, made with a rigid core back layer reinforced with a fiber veil, combined with a flexible core top layer to provide softness and comfort surface. The overall thickness is 4.5 mm. It also includes anti-skid backing to allow an easy installation and a glue-free installation up to 30 sqm.

It benefits from a cross-linked polyurethane surface treatment (**PUR+ MATT**), making maintenance easier and eliminating the need for initial polishes.

**CREATION 55 LOOSELAY** is a loose-lay floorcovering, resistant to use (commercial / industrial use) of 33-42 according to EN-ISO 10874 and has B<sub>fl</sub>-s1 class for smoke emission according to EN 13501-1.

**CREATION 55 LOOSELAY** is made with phthalate free plasticizers, except recycled content. It is 100% recyclable and made with 35% of recycled content. It is REACH compliant. The product emission rate of organic compounds is < 10 microgram/m<sup>3</sup> (TVOC < 28 days – ISO 16000-6).

## EXPLORE THE WORLD OF POSSIBILITIES

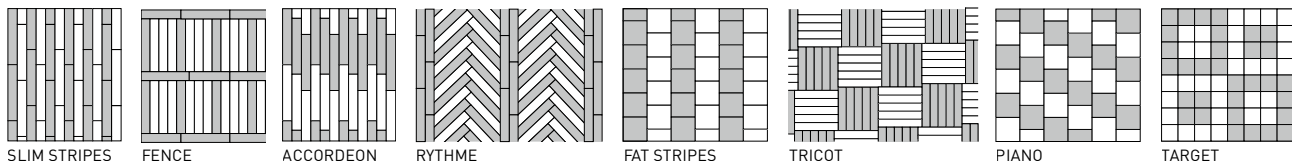

				CREATION 55 LOOSELAY	
DESCRIPTION					
Total thickness	EN ISO 24346	mm	4.50		
Thickness of wearlayer	EN ISO 24340	mm	0.55		
Weight	EN ISO 23997	g/sqm	7500		
Size	EN ISO 24342	mm	229 x 1219	500 x 500	
Number of planks / tiles and sqm per box	-	-	8 / 2.23	8 / 2.0	
CLASSIFICATION					
Norm / Product specification	-	-	EN ISO 10582		
European classification	EN ISO 10874	class	33-42		
Fire rating	EN 13501-1	class	B <sub>fl</sub> -s1		
Static electrical propensity	EN 1815	kV	< 2		
Slip resistance wet: ramp test with oil	DIN 51 130	class	R10		
PERFORMANCES					
Wear resistance	EN 660.2	mm <sup>3</sup>	≤ 2.0		
Wear group	-	group	T		
Type Binder content	ISO 10582	type	I		
Room impact	NF S 31074	dB	73		
Room sound insulation	EN ISO 717-2	dB	7		
Dimensional stability (norm)	EN ISO 23999	%	≤ 0.15		
Dimensional stability (average measured value)	EN ISO 23999	%	≤ 0.05		
Residual indentation	EN ISO 24343-1	mm	≤ 0.10		
Castor chair test (type H)	ISO 4918	-	OK		
Thermal conductivity	EN ISO 10456	W/(m.k)	0.25		
Colour fastness	EN 20 105 - B02	degree	≥ 6		
Surface treatment	-	-	PUR+ Matt		
Chemical products resistance	EN ISO 26987	-	OK		
ENVIRONMENT / INDOOR AIR QUALITY					
TVOC after 28 days	ISO 16000-6	microgram/m <sup>3</sup>	< 10		
CE MARKING					
CE	EN 14041				



# LUXURY VINYL TILE

## CREATION 55 LOOSELAY ACOUSTIC

### ▶ CREATION 55 LOOSELAY ACOUSTIC

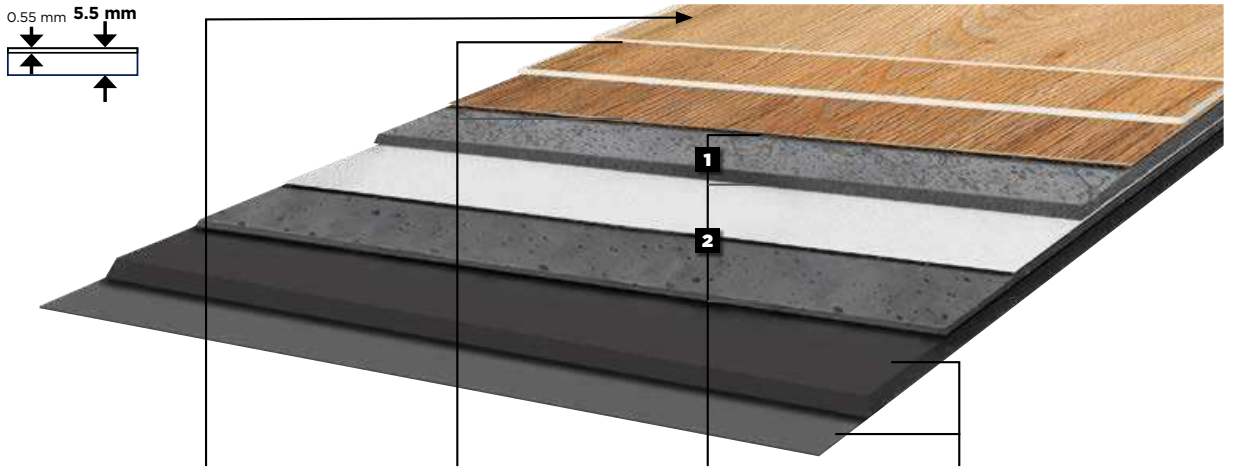

<p><b>PUR+ MATT</b></p> <p>Easy maintenance</p>	<p><b>4D DESIGN</b></p> <p><b>MATT SURFACE</b></p> <p>Natural look</p> <p><b>CRISTAL WEAR LAYER</b></p> <p>High definition design &amp; color</p> <p><b>STRUCTURED EMBOSS</b></p> <p>Ultra realistic surface</p> <p><b>MIX&amp;MATCH DESIGNS</b></p> <p>Easy mix&amp;match of designs &amp; formats</p>	<p><b>DUO CORE TECHNOLOGY</b></p> <p><b>1 RESILIENT COMFORT CORE</b></p> <p>Noise absorption</p> <p>Soft underfoot</p> <p><b>2 RIGID CORE</b></p> <p>The best stability / Fiber glass inside</p> <p>Renovation ceramic 4 mm joint</p>	<p><b>INSULATION ULTRA</b></p> <p><b>ACOUSTIC BACKING</b></p> <p>19 dB</p>
---	---	---	--

Product available on order with a minimum order quantity of 500 sqm and a lead time of 4 months.

### QUICK & EASY TO INSTALL

Please refer to Gerflor's installation guidelines



Installation with tackifier



Apply planks or tiles



Pressure roller



Easy to replace a plank

# CREATION 55 LOOSELAY ACOUSTIC

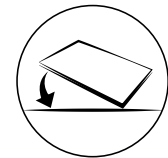

**CREATION 55 LOOSELAY ACOUSTIC** is a synthetic, decorative, flexible, antistatic, abrasion group T floorcoverings available in tiles and planks with bevelled edges. It consists in a 0.55 mm thick transparent wear layer, a design film and a Duo Core Technology, made with a rigid core back layer reinforced with a fiber veil, combined with a flexible core top layer to provide softness and comfort surface. The backing integrates an acoustic core reaching 19 dB acoustic impact noise reduction. The overall thickness is 5.5 mm.

They benefit from a cross-linked polyurethane surface treatment (**PUR+ MATT**), making maintenance easier and eliminating the need for initial polishes.

**CREATION 55 LOOSELAY ACOUSTIC** is a loose lay floorcovering, resistant to use (commercial / industrial use) of 33-42 according to EN-ISO 10874 and has Bfl-s1 class for smoke emission according to EN 13501-1.

**CREATION 55 LOOSELAY ACOUSTIC** is made with phthalate free plasticizers, except recycled content. It is 100% recyclable and made with 35% of recycled content. It is REACH compliant. The product emission rate of organic compounds is < 10 microgram/m<sup>3</sup> (TVOC < 28 days – ISO 16000-6).

## EXPLORE THE WORLD OF POSSIBILITIES

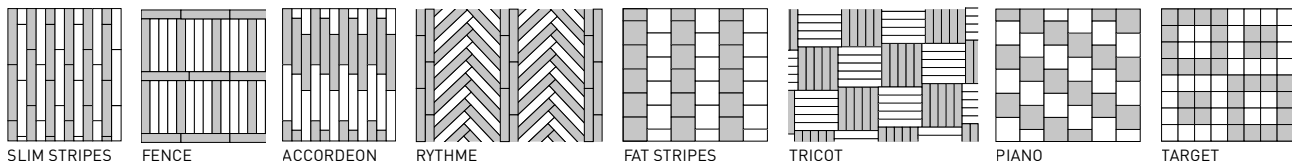

## CREATION 55 LOOSELAY ACOUSTIC

DESCRIPTION			
Total thickness	EN ISO 24346	mm	5.50
Thickness of wearlayer	EN ISO 24340	mm	0.55
Weight	EN ISO 23997	g/sqm	7600
Size	EN ISO 24342	mm	229 x 1219
Number of planks / tiles and sqm per box	-	-	8 / 2.23
			500 x 500
			8 / 2.0
CLASSIFICATION			
Norm / Product specification	-	-	EN 651
European classification	EN ISO 10874	class	33-42
Fire rating	EN 13501-1	class	Bfl-s1
Static electrical propensity	EN 1815	kV	< 2
Slip resistance wet: ramp test with oil	DIN 51 130	class	R10
PERFORMANCES			
Wear resistance	EN 660.2	mm <sup>3</sup>	≤ 2.0
Wear group	-	group	T
Room impact	NF S 31074	dB	70
Room sound insulation	EN ISO 717-2	dB	19
Dimensional stability (norm)	EN ISO 23999	%	≤ 0.15
Dimensional stability (average measured value)	EN ISO 23999	%	≤ 0.05
Residual indentation	EN ISO 24343-1	mm	≤ 0.20
Castor chair test (type H)	ISO 4918	-	OK
Thermal conductivity	EN ISO 10456	W/(m.k)	0.25
Colour fastness	EN 20 105 - B02	degree	≥ 6
Surface treatment	-	-	PUR+ Matt
Chemical products resistance	EN ISO 26987	-	OK
ENVIRONMENT / INDOOR AIR QUALITY			
TVOC after 28 days	ISO 16000-6	microgram/m <sup>3</sup>	< 10
CE MARKING			
CE	EN 14041		

# LUXURY VINYL TILE



CREATION 55 /



CREATION 55 CLIC /



CREATION 55 LOOSELAY / LOOSELAY ACOUSTIC

PUR+ Matt



100% recyclable



0584 White Lime

184 x 1219

214 x 1239



0816 Northwood Macchiato

184 x 1219



0853 Bostonian  
Oak Beige

184 x 1219  
230 x 1500

214 x 1239  
242 x 1461



0060 Arena

184 x 1219

214 x 1239

229 x 1220



0856 Paint Wood Taupe

184 x 1219

214 x 1239



0068 Mansfield Light

184 x 1219



0456 Ranch

184 x 1219  
230 x 1500

214 x 1239  
242 x 1461

229 x 1220



0447 Amador

184 x 1219

214 x 1239

229 x 1220



0810 Chevron Moka

184 x 1219



0847 Swiss Oak Smoked

184 x 1219  
230 x 1500

214 x 1239  
242 x 1461





GLUE DOWN



INTERLOCKING

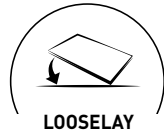

LOOSELAY  
REMOVABLE



0809 Chevron Hurricane



0858 Stripe Oak Ice

184 x 1219 | 214 x 1239



0846 Swiss Oak Pearl

184 x 1219 | 214 x 1239 | 229 x 1220  
230 x 1500 | 242 x 1461



0061 Oxford

184 x 1219 | 214 x 1239



0855 Bostonian Oak Grey

184 x 1219 | 214 x 1239  
230 x 1500 | 242 x 1461



0809 Chevron Hurricane

184 x 1219



Creation  
LVT

DESIGN SHADE VARIATION:



Light



Medium



High

# LUXURY VINYL TILE



CREATION 55 /



CREATION 55 CLIC /



CREATION 55 LOOSELAY / LOOSELAY ACOUSTIC

PUR+ Matt



100% recyclable



0448 Malua Bay



184 x 1219



214 x 1239



229 x 1220



0863 Eramosa Beige



457 x 914



391 x 729



0857 Stripe Oak Honey



184 x 1219



214 x 1239



0441 Honey Oak



184 x 1219



214 x 1239



229 x 1220



0069 Mansfield Natural



184 x 1219



0817 Northwood Mokaccino



184 x 1219



0871 Bostonian Oak



184 x 1219



214 x 1239



0455 Longboard



184 x 1219



214 x 1239



229 x 1220



0579 Amarante



184 x 1219



214 x 1239



0811 Chevron Buckwheat



184 x 1219





GLUE DOWN



INTERLOCKING

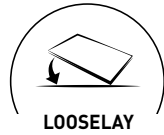

LOOSELAY  
REMOVABLE



0848 Swiss Oak Beige

184 x 1219 | 230 x 1500  
152 x 762 | 214 x 1239  
242 x 1461



0504 Twist

184 x 1219 | 214 x 1239 | 229 x 1220



0795 Swiss Oak Cashmere

184 x 1219 | 230 x 1500 | 214 x 1239  
242 x 1461



0426 Vintage Oak

184 x 1219



0458 Aspen

184 x 1219 | 214 x 1239



0851 Bostonian Oak Honey

Creation  
LVT

DESIGN SHADE VARIATION:



Light



Medium



High



# LUXURY VINYL TILE



CREATION 55 /



CREATION 55 CLIC /



CREATION 55 LOOSELAY / LOOSELAY ACOUSTIC

PUR+ Matt



100% recyclable



0812 Royal Oak Blond

184 x 1219



0796 Swiss Oak Golden

184 x 1219 | 230 x 1500 | 214 x 1239 | 242 x 1461 | 229 x 1220



0459 Brownie

184 x 1219 | 214 x 1239



0461 Michigan

184 x 1219 | 214 x 1239



0740 Royal Oak Coffee

184 x 1219



0740 Royal Oak Coffee



GLUE DOWN



INTERLOCKING



LOOSELAY  
REMOVABLE



0849 Cedar Pure

230 x 1500 | 242 x 1461



0465 Cambridge

184 x 1219 | 214 x 1239



0851 Bostonian Oak Honey

184 x 1219  
 230 x 1500 | 214 x 1239  
 242 x 1461



0347 Ballerina

184 x 1219  
 152 x 762 | 214 x 1239 | 229 x 1220



0850 Cedar Brown

230 x 1500 | 242 x 1461



0870 Quartet Honey

184 x 1219



0445 Rustic Oak

184 x 1219 | 214 x 1239



0859 Quartet Fauve

184 x 1219 | 214 x 1239



0457 Buffalo

184 x 1219 | 214 x 1239



0503 Quartet

184 x 1219  
 152 x 762 | 214 x 1239



DESIGN SHADE VARIATION:



Light



Medium



High

# LUXURY VINYL TILE



CREATION 55 /



CREATION 55 CLIC /



CREATION 55 LOOSELAY / LOOSELAY ACOUSTIC

PUR+ Matt



100% recyclable



0861 Reggia Ivory

457 x 914

391 x 729



0866 Bloom Taupe

610 x 610

391 x 729



0618 Carmel

457 x 914

391 x 729

500 x 500



0868 Bloom Uni Taupe

610 x 610

391 x 729



0751 Durango Taupe

610 x 610

391 x 729



0862 Reggia Taupe

457 x 914



0094 Rust Metal

457 x 914



0373 Silver City

610 x 610

391 x 729



0095 Rust Corten

457 x 914

391 x 729



0860 Norwegian Stone

457 x 914

391 x 729

500 x 500







GLUE DOWN



INTERLOCKING

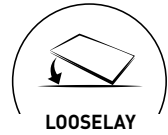

LOOSELAY  
REMOVABLE



0744 Carrare

457 x 914 | 391 x 729

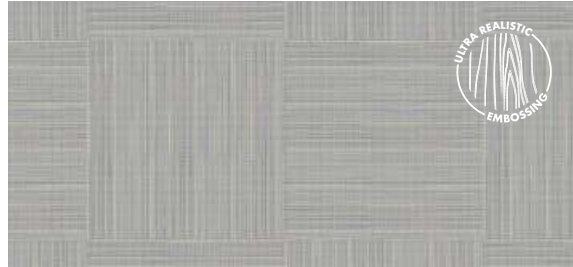

0876 Ponto Cruz Navy

610 x 610 | 152 x 762 | 500 x 500



0869 Bloom Uni Grey

610 x 610 | 391 x 729



0476 Staccato

610 x 610 | 391 x 729

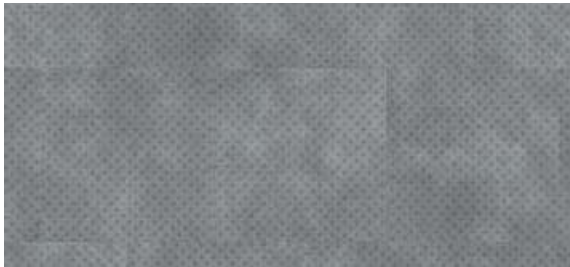

0867 Bloom Grey

610 x 610 | 391 x 729



0436 Riverside

610 x 610 | 391 x 729



0878 Ponto Cruz City

610 x 610 | 152 x 762 | 500 x 500



0374 Parker Station

610 x 610 | 391 x 729 | 500 x 500



Creation  
LVT

DESIGN SHADE VARIATION:



Light



Medium



High

# LUXURY VINYL TILE

## CROSS REFERENCES

	CODE	EMBOSS	CREATION 55	CREATION 55 CLIC	CREATION 55 LOOSELAY/ LOOSELAY ACOUSTIC	SKIRTINGS (MATCHING DESIGNS)
AMADOR	0447	SAW EFFECT	■	■	■	S004
ARENA	0060	SAW EFFECT	■	■	■	S026
BALLERINA	0347	NATURAL	■	■	■	S008
CARMEL	0618	HAMMERED	■	■	■	S020
HONEY OAK	0441	NATURAL	■	■	■	S033
LONG BOARD	0455	BRUSHED	■	■	■	S034
MALUA BAY	0448	BRUSHED	■	■	■	S035
NORVEGIAN STONE	0860	HAMMERED	■	■	■	S042
PARKER STATION	0374	HAMMERED	■	■	■	S047
RANCH	0456	BRUSHED	■	■	■	S053
SWISS OAK GOLDEN	0796	NATURAL	■	■	■	S015
SWISS OAK PEARL	0846	NATURAL	■	■	■	S014
TWIST	0504	NATURAL	■	■	■	S039
AMARANTE	0579	BRUSHED	■	■	■	S005
ASPEN	0458	BRUSHED	■	■	■	S006
BLOOM GREY	0867	HAMMERED	■	■	■	S069
BLOOM TAUPE	0866	HAMMERED	■	■	■	S070
BLOOM UNI GREY	0869	HAMMERED	■	■	■	S071
BLOOM UNI TAUPE	0868	HAMMERED	■	■	■	S072
BOSTONIAN OAK	0871	NATURAL	■	■	■	S016
BOSTONIAN OAK BEIGE	0853	NATURAL	■	■	■	S017
BOSTONIAN OAK GREY	0855	NATURAL	■	■	■	S018
BOSTONIAN OAK HONEY	0851	NATURAL	■	■	■	S019
BROWNIE	0459	NATURAL	■	■	■	S073
BUFFALO	0457	BRUSHED	■	■	■	S075
CAMBRIDGE	0465	NATURAL	■	■	■	S065
CARRARE	0744	STONE	■	■	■	S021
CEDAR BROWN	0850	NATURAL	■	■	■	S024
CEDAR PURE	0849	NATURAL	■	■	■	S025
DURANGO TAUPE	0751	HAMMERED	■	■	■	S027
ERAMOSA BEIGE	0863	NATURAL	■	■	■	S028
MICHIGAN	0461	BRUSHED	■	■	■	S038
OXFORD	0061	BRUSHED	■	■	■	S043
PAINT WOOD TAUPE	0856	BRUSHED	■	■	■	S046
QUARTET	0503	NATURAL	■	■	■	S056
QUARTET FAUVE	0859	NATURAL	■	■	■	S057
REGGIA IVORY	0861	STONE	■	■	■	S054
RIVERSIDE	0436	HAMMERED	■	■	■	S032
RUST CORTEN	0095	PERFORATED	■	■	■	S044
RUSTIC OAK	0445	BRUSHED	■	■	■	S062
SILVER CITY	0373	HAMMERED	■	■	■	S048
STACCATO	0476	PERFORATED	■	■	■	S064
STRIPE OAK HONEY	0857	NATURAL	■	■	■	S010
STRIPE OAK ICE	0858	NATURAL	■	■	■	S009
SWISS OAK BEIGE	0848	NATURAL	■	■	■	S011
SWISS OAK CASHMERE	0795	NATURAL	■	■	■	S012
SWISS OAK SMOKED	0847	NATURAL	■	■	■	S013
WHITE LIME	0584	SAW EFFECT	■	■	■	S074
PONTO CRUZ CITY	0878	TEXTILE	■	■	■	S052
PONTO CRUZ NAVY	0876	TEXTILE	■	■	■	S051
CHEVRON BUCKWHEAT	0811	CHEVRON	■	■	■	S029
CHEVRON HURRICANE	0809	CHEVRON	■	■	■	S030
CHEVRON MOKA	0810	CHEVRON	■	■	■	S031
MANSFIELD LIGHT	0068	BRUSHED	■	■	■	S036
MANSFIELD NATURAL	0069	BRUSHED	■	■	■	S037
NORTHWOOD MACHIATTO	0816	BRUSHED	■	■	■	S040
NORTHWOOD MOKACCINO	0817	BRUSHED	■	■	■	S041
QUARTET HONEY	0870	NATURAL	■	■	■	S058
REGGIA TAUPE	0862	STONE	■	■	■	S055
ROYAL OAK BLOND	0812	ROYAL OAK	■	■	■	S060
ROYAL OAK COFFEE	0740	ROYAL OAK	■	■	■	S061
RUST METAL	0094	PERFORATED	■	■	■	S045
VINTAGE OAK	0426	BRUSHED	■	■	■	S063

■: Available

## PACKAGING

Product size (mm)	m <sup>2</sup> / box	m <sup>2</sup> / palette
-------------------	----------------------	--------------------------

### CREATION 55

152 x 762	3.82	214.04
184 x 1219	3.36	215.32
184 x 1219*	3.14	213.53
230 x 1500	3.11	214.25
457 x 914	3.76	218.04
610 x 610	3.35	187.54

### CREATION 55 CLIC

214 x 1239	1.86	106
242 x 1461	2.12	101.8
391 x 729	1.71	102.6

### CREATION 55 LOOSELAY

229 x 1220	2.23	124.88
500 x 500	2	128

\* CHEVRON design only



# EXCLUSIVE EMBOSSES FOR ENHANCED DESIGNS

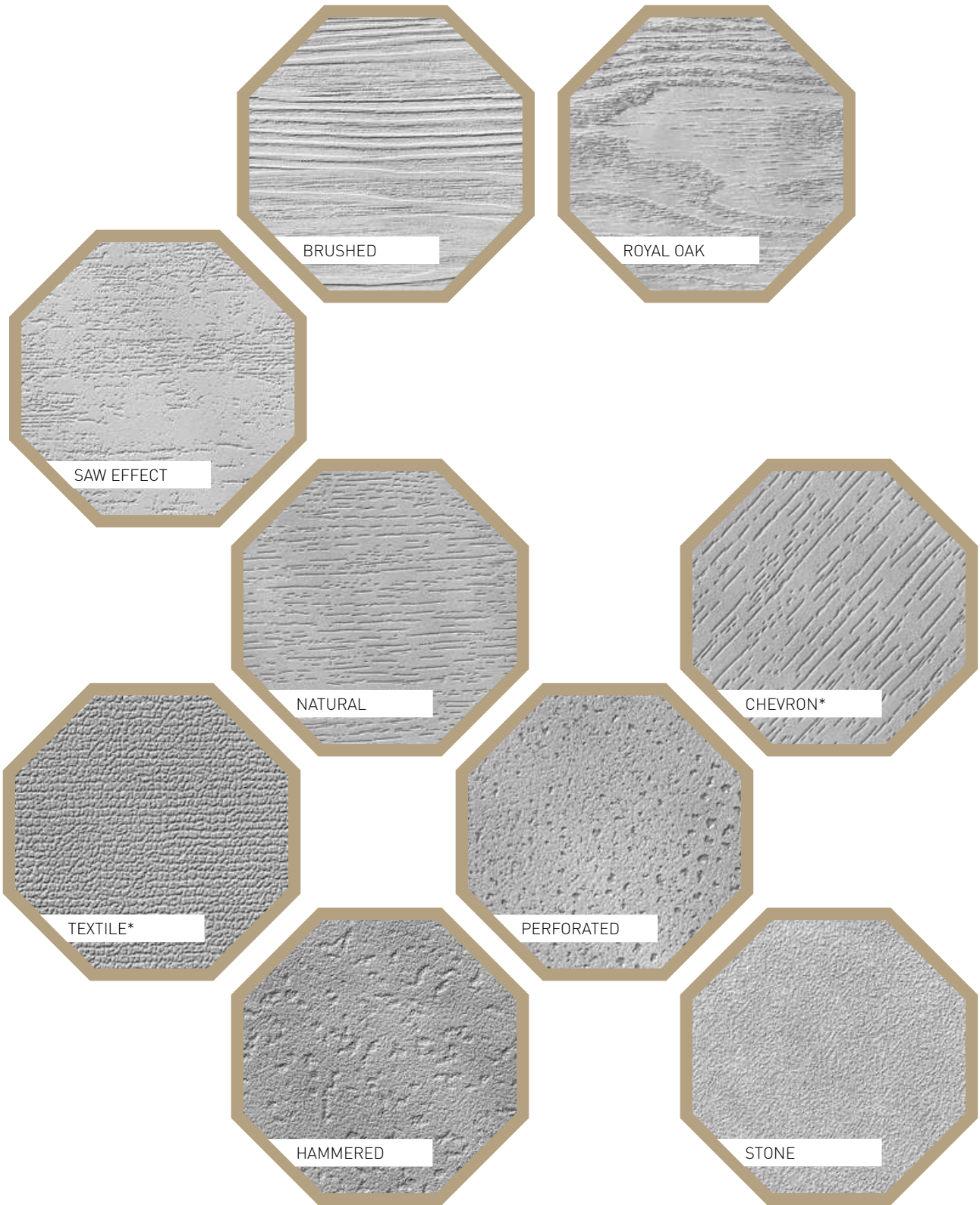

Creation  
LVT





# LUXURY VINYL TILE

## RIGID 55 LOCK ACOUSTIC

### ▶ RIGID 55 LOCK ACOUSTIC

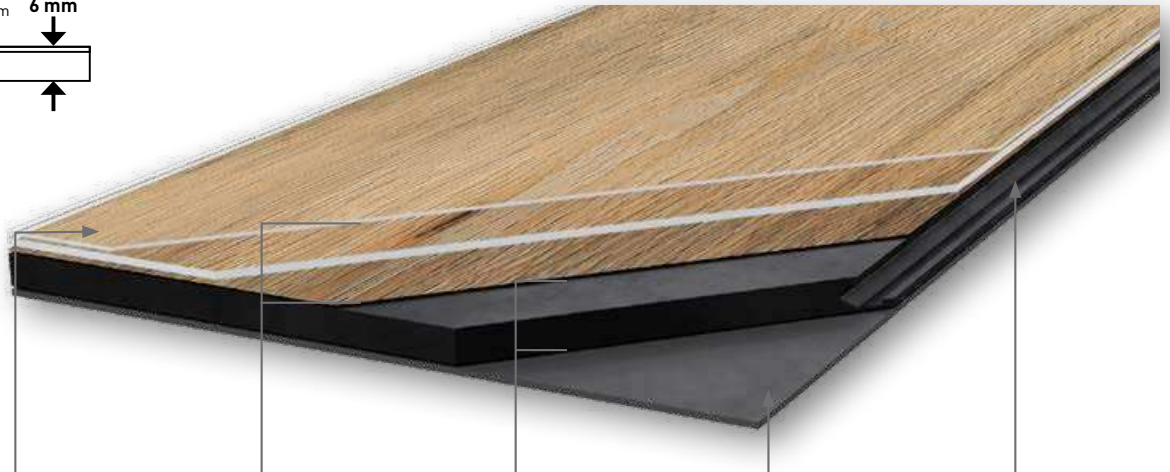
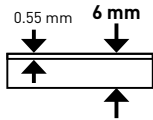

**PUR+ MATT**

Easy maintenance

**4D DESIGN**

**MATT SURFACE**

Natural look

**CRISTAL WEAR LAYER**

High definition design & color

**STRUCTURED EMBOSS & BEVEL**

Ultra realistic surface

**XL FORMAT**

Wide variety of tiles & planks

**FULL RIGID CORE TECHNOLOGY**

Rigid

---

60 °C  
140 °F  
Max.

---

The best stability

---

Renovation ceramic  
6 mm joint

**INSULATION ULTRA**

**ACOUSTIC BACKING**

19 dB

**LOCK SYSTEM**

Standard laminate installation

Please refer to Gerflor's installation guidelines

### ▶ DESIGN SKIRTINGS (see page 174)

### ▶ ENTRANCE MATS (see page 175)

More details on [gerflor.com](http://gerflor.com)

# RIGID 55 LOCK ACOUSTIC

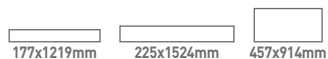
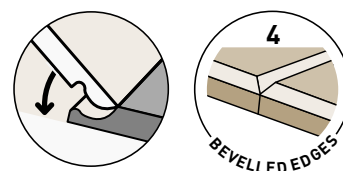

PUR+ Matt 100% recyclable

**RIGID 55 LOCK ACOUSTIC** is a synthetic, decorative, rigid, antistatic floorcovering, available in tiles and planks, with bevelled edges. It consists in a 0.55 mm thick transparent wear layer, a design film, a rigid core board technology and an acoustic underlay integrated reaching 19 dB insulation. The overall thickness is 6 mm.

It benefits from a cross-linked polyurethane surface treatment (**PUR+ MATT**), making maintenance easier and eliminating the need for initial polishes.

**RIGID 55 LOCK ACOUSTIC** is an interlocking floorcovering assembled with an interlocking system, resistant to use (commercial / industrial use) of 33-42 according to EN-ISO 10874 and has B<sub>fl</sub>-s1 class for smoke emission according to EN 13501-1.

**RIGID 55 LOCK ACOUSTIC** is phthalate free, except recycled content. It is 100% recyclable. It is REACH compliant. The product emission rate of organic compounds is < 100 microgram/m<sup>3</sup> (TVOC < 28 days – ISO 16000-6).

## RIGID 55 LOCK ACOUSTIC

DESCRIPTION		RIGID 55 LOCK ACOUSTIC			
Total thickness	EN ISO 24346	mm	6.00		
Thickness of wearlayer	EN ISO 24340	mm	0.55		
Weight	EN ISO 23997	g/sqm	9480		
Size	EN ISO 24342	mm	177 x 1219	225 x 1524	457 x 914
Number of planks /tiles and sqm per box	-	-	8 / 1.73	5 / 1.71	4 / 1.67
CLASSIFICATION					
Norm / Product specification	-	-	EN ISO 10582		
European classification	EN ISO 10874	class	33-42		
Fire rating	EN 13501-1	class	B <sub>fl</sub> -s1		
Static electrical propensity	EN 1815	kV	< 2		
Slip resistance wet	DIN 51 130	class	R10 <sup>(1)</sup>		
PERFORMANCES					
Wear resistance	EN 660.2	mm <sup>3</sup>	≤ 2.0		
Wear group	-	group	T		
Type Binder content	EN ISO 10582	type	I		
Room impact	NF S 31074	dB	81		
Impact sound insulation	EN ISO 717-2	dB	19		
Dimensional stability (norm)	EN ISO 23999	%	≤ 0.15		
Dimensional stability (average measured value)	-	%	≤ 0.05		
Residual indentation	EN ISO 24343-1	mm	≤ 0.10		
Castor chair test (type H)	ISO 4918	-	OK		
Thermal conductivity	EN ISO 10456	W/(m.k)	0.25		
Colour fastness	EN 20 105 - B02	degree	≥ 6		
Surface treatment	-	-	PUR+ Matt		
Chemical products resistance	EN ISO 26987	-	OK		
ENVIRONMENT / INDOOR AIR QUALITY					
TVOC after 28 days	ISO 16000-6	microgram/m <sup>3</sup>	< 100		
CE MARKING					
CE	EN 14041				

(1) Slip resistance wet: details on website gerflor.com

# LUXURY VINYL TILE

## RIGID 55 LOCK ACOUSTIC

177x1219mm

225x1524mm

PUR+ Matt

100% recyclable



0977 Suave Grey



0008 Lovina

177 x 1219 mm



0009 Viajo Grey

177 x 1219 mm



0019 Kilda Pearl

225 x 1524 mm



0977 Suave Grey

177 x 1219 mm



# RIGID 55 LOCK ACOUSTIC

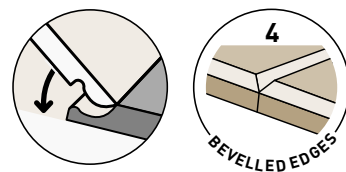

177x1219mm 225x1524mm

PUR+ Matt 100% recyclable



0005 Cocha

177 x 1219 mm



0017 Puno Pure

225 x 1524 mm



0018 Kilda Cashmere

225 x 1524 mm



0004 Sucre

177 x 1219 mm



0003 Viajo

177 x 1219 mm



0002 Hobart

177 x 1219 mm



0001 Puerto

177 x 1219 mm



0015 Kilda Golden

225 x 1524 mm



0979 Crunchy

177 x 1219 mm



0016 Puno Brown

225 x 1524 mm

DESIGN SHADE VARIATION:



Light



Medium



High

Creation  
LVT

# LUXURY VINYL TILE

## RIGID 55 LOCK ACOUSTIC

177x1219mm 225x1524mm 457x914mm | PUR+ Matt | 100% recyclable



0007 Quito

177 x 1219 mm



0006 Uyuni Taupe

177 x 1219 mm



0010 Cartago

177 x 1219 mm



0020 Kilda Smoked

225 x 1524 mm

# RIGID 55 LOCK ACOUSTIC

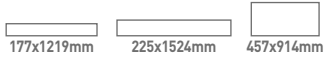
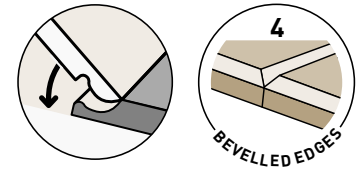

PUR+ Matt



0012 Geelong Grey

457 x 914 mm



0013 Bello

457 x 914 mm



0014 Noosa Corten

457 x 914 mm



0011 Trondheim

457 x 914 mm



## CROSS REFERENCES / RIGID 55 LOCK SYSTEM & CREATION 55

RIGID 55 LOCK ACOUSTIC	CREATION 55 GLUE DOWN / CLIC	CREATION 55 LOOSELAY
Cartago 0010	Amador 0447	Amador 0447
Hobart 0002	Ballerina 0347	Ballerina 0347
Kilda Cashmere 0018	Swiss Oak Cashmere 0795	-
Kilda Smoked 0020	Swiss Oak Smoked 0847	-
Kilda Pearl 0019	Swiss Oak Pearl 0846	Swiss Oak Pearl 0846
Kilda Golden 0015	Swiss Oak Golden 0796	Swiss Oak Golden 0796
Vicjo 0003	Bostonian Oak 0871	-
Vicjo Grey 0009	Bostonian Oak Grey 0855	-
Puno Brown 0016	Cedar Brown 0850	-
Puno Pure 0017	Cedar Pure 0849	-
Bello 0013	Carmel 0618	Carmel 0618
Quito 0007	Arena 0060	Arena 0060
Cocha 0005	Malua Bay 0448	Malua Bay 0448
Sucre 0004	Twist 0504	Sucre 0004
Trondheim 0011	Norwegian Stone 0860	Norwegian Stone 0860
Noosa Corten 0014	Rust Corten 0095	-
Uyuni Taupe 0006	Paint Wood Taupe 0856	-
Lovina 0008	Ranch 0456	Ranch 0456
Puerto 0001	Quartet 0503	-
Geelong Grey 0012	Bloom Uni Grey 0869	-
Crunchy 0979	Buffalo 0457	-
Suave Grey 0977	Oxford 0061	-

Creation  
LVT

DESIGN SHADE VARIATION:



Light



Medium



High



# LUXURY VINYL TILE

## CREATION 30

### ▶ CREATION 30

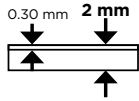

<p><b>PUR+ MATT</b></p> <p>Easy maintenance</p>	<p><b>4D DESIGN</b></p> <p><b>MATT SURFACE</b></p> <p>Natural look</p> <p><b>CRISTAL WEAR LAYER</b></p> <p>High definition design &amp; color</p> <p><b>STRUCTURED EMOSS &amp; MICRO-BEVEL</b></p> <p>Ultra realistic surface</p> <p><b>DESIGNS</b></p> <p>Wide variety of planks or tiles</p>	<p><b>RESILIENT COMFORT CORE</b></p> <p>Noise absorption</p> <p>Soft underfoot</p>	<p><b>DIAMOND BACKLAYER</b></p> <p><b>BODY &amp; STRENGTH</b></p> <p>Easy handling</p> <p><b>BACK EMOSS</b></p> <p>Better subfloor adhesion</p> <p>Easy positioning</p>
---	--	--	---



Please refer to Gerflor's installation guidelines



Format: 1 m x 7.5 lm  
Ref.: 1698

More details on [gerflor.com](http://gerflor.com)

# CREATION 30

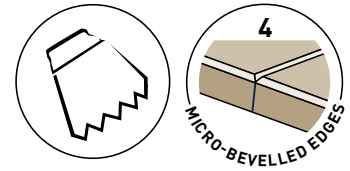

PUR+ Matt



**CREATION 30 DESIGN** is a synthetic, decorative, flexible, antistatic abrasion group T floorcovering available in tile or plank, with bevelled edges. It consists in a 0.3 mm thick transparent wear layer, a design film and a Resilient Comfort Core to provide softness and comfort surface. The overall thickness is 2 mm.

It benefits from a cross-linked polyurethane surface treatment (**PUR+ MATT**), making maintenance easier and eliminating the need for initial polishes.

**CREATION 30 DESIGN** is a glued floorcovering, resistant to use (residential / commercial use) of 23-31 according to EN-ISO 10874 and has B<sub>fl</sub>-s1 class for smoke emission according to EN 13501-1.

**CREATION 30 DESIGN** is made with phthalate free plasticizers, except recycled content. It is 100% recyclable and made with 35% of recycled content. It is REACH compliant. The product emission rate of organic compounds is < 10 microgram/m<sup>3</sup> (TVOC < 28 days – ISO 16000-6).

Creation  
LVT

		CREATION 30					
		DESIGN					
DESCRIPTION							
Total thickness	EN ISO 24346	mm	2.00				
Thickness of wearlayer	EN ISO 24340	mm	0.30				
Weight	EN ISO 23997	g/sqm	3460				
Size	EN ISO 24342	mm	184 x 1219	230 x 1500	457 x 914	610 x 610	
Number of planks /tiles and sqm per box	-	-	15 / 3.36 14 / 3.14 (Chevron)	11 / 3.80	9 / 3.76	9 / 3.35	
CLASSIFICATION							
Norm / Product specification	-	-	EN ISO 10582				
European classification	EN ISO 10874	class	23 - 31				
Fire rating	EN 13501-1	class	B <sub>fl</sub> -s1				
Static electrical propensity	EN 1815	kV	< 2				
Slip resistance wet: ramp test with oil	DIN 51 130	class	R10				
PERFORMANCES							
Wear resistance	EN 660.2	mm <sup>3</sup>	≤ 2.0				
Wear group	-	group	T				
Type Binder content	ISO 10582	type	I				
Room impact	NF S 31074	dB	77				
Impact sound insulation	EN ISO 717-2	dB	4				
Dimensional stability (norm)	EN ISO 23999	%	≤ 0.25				
Dimensional stability (average measured value)	-	%	≤ 0.10				
Residual indentation	EN ISO 24343-1	mm	≤ 0.10				
Castor chair test (type H)	ISO 4918	-	OK				
Thermal conductivity	EN ISO 10456	W/(m.k)	0.25				
Colour fastness	EN 20 105 - B02	degree	≥ 6				
Surface treatment	-	-	PUR+ Matt				
Chemical products resistance	EN ISO 26987	-	OK				
ENVIRONMENT / INDOOR AIR QUALITY							
TVOC after 28 days	ISO 16000-6	microgram/m <sup>3</sup>	< 10				
CE MARKING							
CE	EN 14041						

# LUXURY VINYL TILE

## CREATION 30 CLIC

### ▶ CREATION 30 CLIC

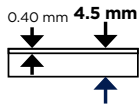

PUR+ MATT	4D DESIGN	DUO CORE TECHNOLOGY	CLIC REVOLUTION 100% VERTICAL
<p>Easy maintenance</p>	<p><b>MATT SURFACE</b></p> <p>Natural look</p>	<p><b>1 RESILIENT COMFORT CORE</b></p> <p>Noise absorption</p> <p>Soft underfoot</p>	<p>30% Faster</p> <p>Durable clic system</p>
	<p><b>CRISTAL WEAR LAYER</b></p> <p>High definition design &amp; color</p>	<p><b>2 RIGID CORE WITH FIBER GLASS VEIL</b></p> <p>The best stability</p> <p>No adhesive</p>	<p>Heavy load resistance</p> <p>Waterproof joints</p>
	<p><b>STRUCTURED EMBOSS &amp; BEVEL</b></p> <p>Ultra realistic surface</p>	<p>Renovation ceramic 4 mm joint</p>	<p>Easy to change a plank</p>
	<p><b>2M PATTERN DESIGN</b></p> <p>Wide variety of planks or tiles</p>		

Please refer to Gerflor's installation guidelines

**UNDERLAY GERFLOR ACOUSTIQUE / 15 dB**



Format: 1 m x 15 lm  
Ref.: 1798

**UNDERLAY GERFLOR SILENCE PLUS / 19 dB**



Format: 1.18 m x 8.5 lm  
Ref.: 5949

**ROMUS TOOLS**  
Anti-bounce mallet - Fitter Knife - LVT Roller



More details on [gerflor.com](http://gerflor.com)



# CREATION 30 CLIC

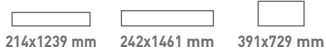
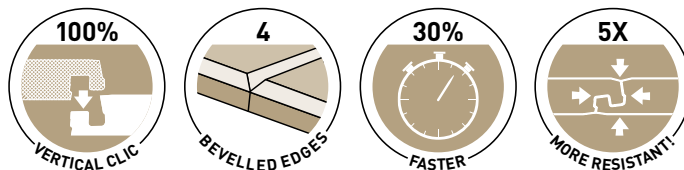

PUR+ Matt 100% recyclable

**CREATION 30 CLIC** is a synthetic, decorative, flexible, antistatic, abrasion group T floorcovering available in tiles and planks, with bevelled edges. It consists in a 0.4 mm thick transparent wear layer, a design film of 2 m width to have more variety in the design and a Duo Core Technology, made with a rigid core back layer reinforced with a fiber veil, combined with a flexible core top layer to provide softness and comfort surface. The overall thickness is 4.5 mm.

It benefits from a cross-linked polyurethane surface treatment (**PUR+ MATT**), making maintenance easier and eliminating the need for initial polishes.

**CREATION 30 CLIC** is an interlocking floorcovering assembled with a vertical system on the long and short side for a quick and solid installation. The resistance to use (commercial / industrial use) of 23-32 according to EN-ISO 10874 and has B<sub>fl</sub>-s1 class for smoke emission according to EN 13501-1.

**CREATION 30 CLIC** is made with phthalate free plasticizers, except recycled content. It is 100% recyclable and made with 55% of recycled content. It is 100% compliant with REACH. The product emission rate of organic compounds is < 10 microgram/m<sup>3</sup> (TVOC < 28 days – ISO 16000-6).

## CREATION 30 CLIC

DESCRIPTION					
Total thickness	EN ISO 24346	mm	4.50		
Thickness of wearlayer	EN ISO 24340	mm	0.40		
Weight	EN ISO 23997	g/sqm	7385		
Plank size	EN ISO 24342	mm	214 x 1239	242 x 1461	391 x 729
Number of planks /tiles and sqm per box	-	-	8 / 2.12	7 / 2.47	8 / 2.28
CLASSIFICATION					
Norm / Product specification	-	-	EN ISO 10582		
European classification	EN ISO 10874	class	32		
Fire rating	EN 13501-1	class	B <sub>fl</sub> -s1		
Static electrical propensity	EN 1815	kV	< 2		
Slip resistance wet: ramp test with oil	DIN 51 130	class	R10		
PERFORMANCES					
Wear resistance	EN 660.2	mm <sup>3</sup>	≤ 2.0		
Wear group	-	group	T		
Type Binder content	ISO 10582	type	I		
Room impact	NF S 31074	dB	78		
Impact sound insulation	EN ISO 717-2	dB	4		
Dimensional stability (norm)	EN ISO 23999	%	≤ 0.15		
Dimensional stability (average measured value)	-	%	≤ 0.05		
Residual indentation	EN ISO 24343-1	mm	≤ 0.10		
Castor chair test (type H)	ISO 4918	-	OK		
Thermal conductivity	EN ISO 10456	W/(m.k)	0.25		
Colour fastness	EN 20 105 - B02	degree	≥ 6		
Surface treatment	-	-	PUR+ Matt		
Chemical products resistance	EN ISO 26987	-	OK		
ENVIRONMENT / INDOOR AIR QUALITY					
TVOC after 28 days	ISO 16000-6	microgram/m <sup>3</sup>	< 10		
Certification	-	-	Floorscore®		
CE MARKING					
	EN 14041				

# LUXURY VINYL TILE

CREATION 30 /  
CREATION 30 CLIC

PUR+ Matt | 100% recyclable



0584 White Lime

184 x 1219

214 x 1239



0853 Bostonian Oak Beige

184 x 1219  
230 x 1500

214 x 1239  
242 x 1461



0456 Ranch

184 x 1219  
230 x 1500

214 x 1239  
242 x 1461



0738 Alamo Sand

184 x 1219



0458 Aspen

184 x 1219

214 x 1239



0816 Northwood Macchiato

184 x 1219



0060 Arena

184 x 1219 | 214 x 1239



0737 Alamo Ash

184 x 1219



0447 Amador

184 x 1219 | 214 x 1239



0846 Swiss Oak Pearl

184 x 1219 | 214 x 1239  
 230 x 1500 | 242 x 1461



0855 Bostonian Oak Grey

184 x 1219 | 214 x 1239  
 230 x 1500 | 242 x 1461



0061 Oxford

184 x 1219 | 214 x 1239



0847 Swiss Oak Smoked

184 x 1219 | 214 x 1239  
 230 x 1500 | 242 x 1461



0809 Chevron Hurricane

184 x 1219



DESIGN SHADE VARIATION:



Light



Medium



High



# LUXURY VINYL TILE



CREATION 30 /  
CREATION 30 CLIC

PUR+ Matt



100% recyclable



0504 Twist

184 x 1219 | 214 x 1239



0848 Swiss Oak Beige

184 x 1219 | 214 x 1239  
230 x 1500 | 242 x 1461



0795 Swiss Oak Cashmere

184 x 1219 | 214 x 1239  
230 x 1500 | 242 x 1461



0817 Northwood Mokaccino

184 x 1219



0811 Chevron Buckwheat

184 x 1219



0455 Longboard

184 x 1219 | 214 x 1239



0742 Timber Camel

184 x 1219



0871 Bostonian Oak

184 x 1219 | 214 x 1239



0741 Timber Rust

184 x 1219



0740 Royal Oak Coffee

184 x 1219



0849 Cedar Pure / 0744 Carrare



0448 Malua Bay

184 x 1219 | 214 x 1239



0849 Cedar Pure

230 x 1500 | 242 x 1461



0441 Honey Oak

184 x 1219 | 214 x 1239



0579 Amarante

184 x 1219 | 214 x 1239



DESIGN SHADE VARIATION:



Light



Medium



High

# LUXURY VINYL TILE



CREATION 30 /  
CREATION 30 CLIC

PUR+ Matt



100% recyclable



0465 Cambridge

184 x 1219 | 214 x 1239



0870 Quartet Honey

184 x 1219



0347 Ballerina

184 x 1219 | 214 x 1239



0850 Cedar Brown

230 x 1500 | 242 x 1461



0739 Royal Oak Gold

184 x 1219



0812 Royal Oak Blond





0812 Royal Oak Blond

184 x 1219



0874 Timber Gold

184 x 1219



0796 Swiss Oak Golden

184 x 1219  
 230 x 1500 | 214 x 1239  
 242 x 1461



0851 Bostonian Oak Honey

184 x 1219  
 230 x 1500 | 214 x 1239  
 242 x 1461



0445 Rustic Oak

184 x 1219 | 214 x 1239



0859 Quartet Fauve

184 x 1219 | 214 x 1239



0461 Michigan

184 x 1219 | 214 x 1239



0503 Quartet

184 x 1219 | 214 x 1239



0459 Brownie

184 x 1219 | 214 x 1239



0457 Buffalo

184 x 1219 | 214 x 1239



DESIGN SHADE VARIATION:



Light



Medium



High

# LUXURY VINYL TILE



CREATION 30 /  
CREATION 30 CLIC

PUR+ Matt



100% recyclable



0861 Reggia Ivory

457 x 914 | 391 x 729



0865 Cementine Buckskin

457 x 914 | 391 x 729



0751 Durango Taupe

610 x 610 | 391 x 729



0747 Pashmina Cloud

457 x 914



0748 Back Street

457 x 914



0618 Carmel

457 x 914 | 391 x 729



0373 Silver City

610 x 610 | 391 x 729

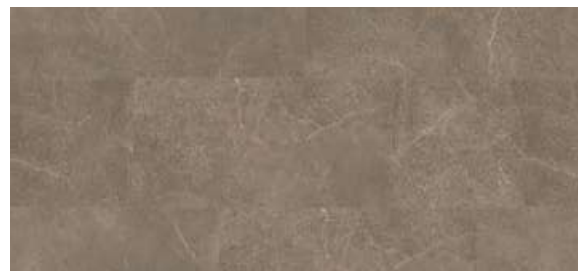

0862 Reggia Taupe

457 x 914



0374 Parker Station

610 x 610 | 391 x 729



0746 Pashmina Storm

457 x 914



GLUE DOWN



INTERLOCKING



0865 Cementine Buckskin / 0618 Carmel



0744 Carrare

457 x 914 | 391 x 729



0864 Cementine Denim

457 x 914 | 391 x 729



0476 Staccato

610 x 610 | 391 x 729



0436 Riverside

610 x 610 | 391 x 729

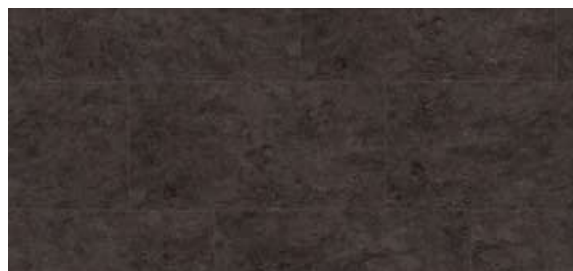

0860 Norwegian Stone

457 x 914 | 391 x 729



Creation  
LVT

DESIGN SHADE VARIATION:



Light



Medium



High



# LUXURY VINYL TILE

## CROSS REFERENCES

CODE	EMBOSS	CREATION 30			S004
		■	■	■	
AMADOR	0447	SAW EFFECT	■	■	S004
AMARANTE	0579	BRUSHED	■	■	S005
ARENA	0060	SAW EFFECT	■	■	S026
ASPEN	0458	BRUSHED	■	■	S006
BALLERINA	0347	NATURAL	■	■	S008
BOSTONIAN OAK	0871	NATURAL	■	■	S016
BOSTONIAN OAK BEIGE	0853	NATURAL	■	■	S017
BOSTONIAN OAK GREY	0855	NATURAL	■	■	S018
BOSTONIAN OAK HONEY	0851	NATURAL	■	■	S019
BROWNIE	0459	NATURAL	■	■	S073
BUFFALO	0457	BRUSHED	■	■	S075
CAMBRIDGE	0465	NATURAL	■	■	S065
CARMEL	0618	HAMMERED	■	■	S020
CARRARE	0744	STONE	■	■	S021
CEDAR BROWN	0850	NATURAL	■	■	S024
CEDAR PURE	0849	NATURAL	■	■	S025
CEMENTINE BUCKSKIN	0865	STONE	■	■	S023
CEMENTINE DENIM	0864	STONE	■	■	S022
DURANGO TAUPE	0751	HAMMERED	■	■	S027
HONEY OAK	0441	NATURAL	■	■	S033
LONG BOARD	0455	BRUSHED	■	■	S034
MALUA BAY	0448	BRUSHED	■	■	S035
MICHIGAN	0461	BRUSHED	■	■	S038
NORVEGIAN STONE	0860	HAMMERED	■	■	S042
OXFORD	0061	BRUSHED	■	■	S043
PARKER STATION	0374	HAMMERED	■	■	S047
QUARTET	0503	NATURAL	■	■	S056
QUARTET FAUVE	0859	NATURAL	■	■	S057
RANCH	0456	BRUSHED	■	■	S053
REGGIA IVORY	0861	STONE	■	■	S054
RIVERSIDE	0436	HAMMERED	■	■	S032
RUSTIC OAK	0445	BRUSHED	■	■	S062
SILVER CITY	0373	HAMMERED	■	■	S048
STACCATO	0476	PERFORATED	■	■	S064
SWISS OAK BEIGE	0848	NATURAL	■	■	S011
SWISS OAK CASHMERE	0795	NATURAL	■	■	S012
SWISS OAK GOLDEN	0796	NATURAL	■	■	S015
SWISS OAK PEARL	0846	NATURAL	■	■	S014
SWISS OAK SMOKED	0847	NATURAL	■	■	S013
TWIST	0504	NATURAL	■	■	S039
WHITE LIME	0584	SAW EFFECT	■	■	S074
ALAMO ASH	0737	ALAMO	■	■	S002
ALAMO SAND	0738	ALAMO	■	■	S003
BACK STREET	0748	HAMMERED	■	■	S007
CHEVRON BUCKWHEAT	0811	CHEVRON	■	■	S029
CHEVRON HURRICANE	0809	CHEVRON	■	■	S030
NORTHWOOD MACCHIATO	0816	BRUSHED	■	■	S040
NORTHWOOD MOKACCINO	0817	BRUSHED	■	■	S041
PASHMINA CLOUD	0747	STONE	■	■	S049
PASHMINA STORM	0746	STONE	■	■	S050
QUARTET HONEY	0870	NATURAL	■	■	S058
REGGIA TAUPE	0862	STONE	■	■	S055
ROYAL OAK BLOND	0812	ROYAL OAK	■	■	S060
ROYAL OAK COFFEE	0740	ROYAL OAK	■	■	S061
ROYAL OAK GOLD	0739	ROYAL OAK	■	■	S059
TIMBER CAMEL	0742	BRUSHED	■	■	S066
TIMBER GOLD	0874	BRUSHED	■	■	S067
TIMBER RUST	0741	BRUSHED	■	■	S068

CREATION 30



CREATION 30 CLIC



SKIRTINGS (MATCHING DESIGNS)



## PACKAGING

Product size (mm)	m <sup>2</sup> / box	m <sup>2</sup> / pallet
-------------------	----------------------	-------------------------

### CREATION 30

184 x 1219	3.36	241.92
184 x 1219*	3.14	251.2
230 x 1500	3.80	250.8
610 x 610	3.35	234.5
457 x 914	3.76	248.16

### CREATION 30 CLIC

214 x 1239	2.12	114.5
242 x 1461	2.47	118.6
391 x 729	2.28	116.3

\* CHEVRON design only

■ : Available

# EXCLUSIVE EMBOSSES FOR ENHANCED DESIGNS

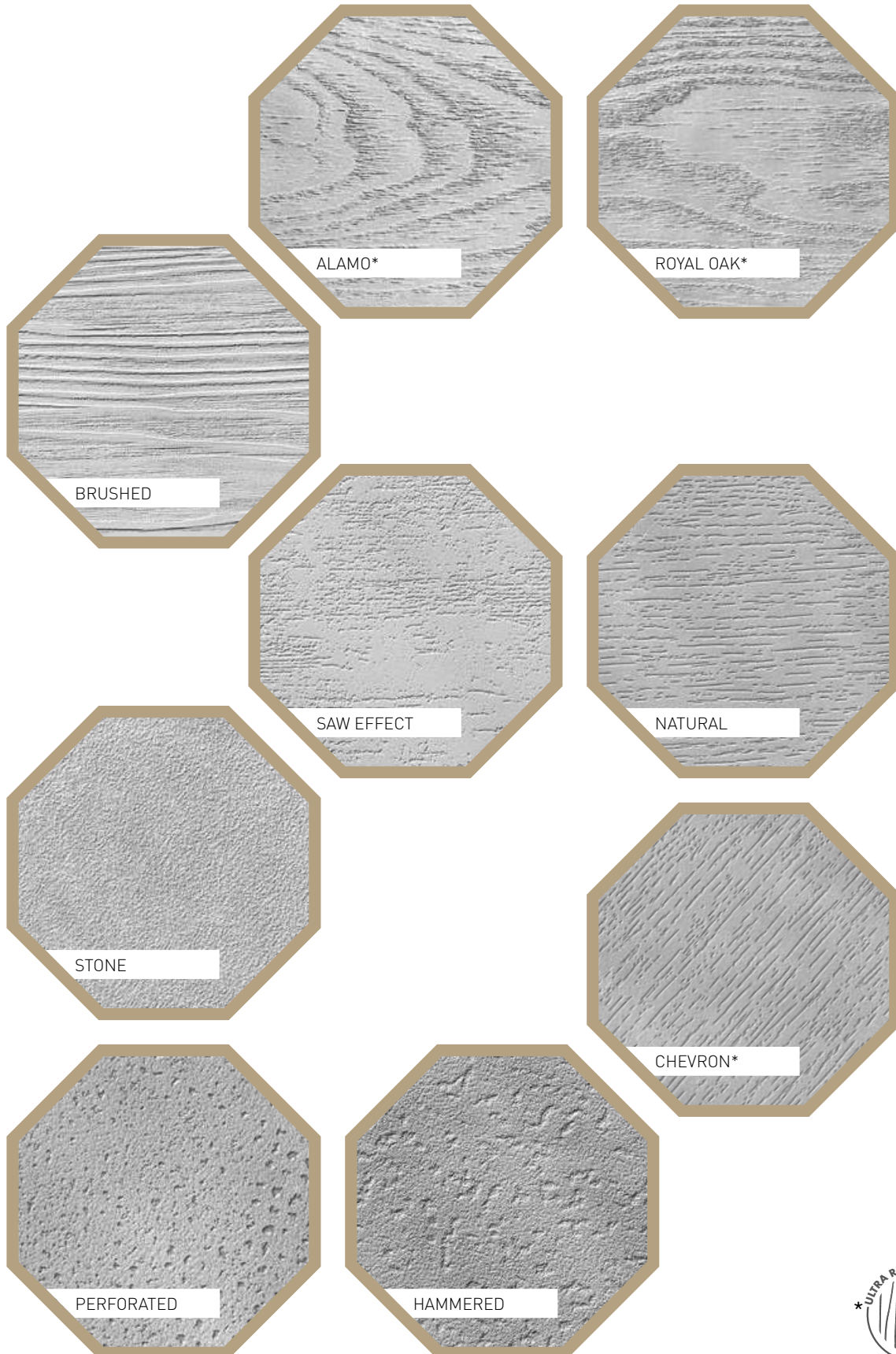

Creation  
LVT



# LUXURY VINYL TILE

## RIGID 30 LOCK

### ▶ RIGID 30 LOCK

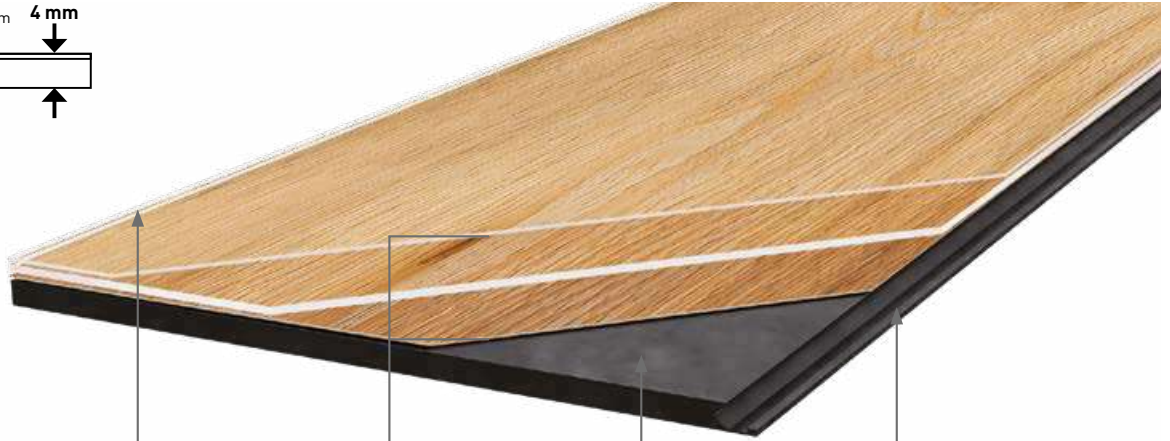
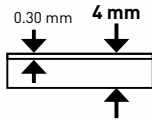

<p><b>PUR+ MATT</b></p> <p>Easy maintenance</p>	<p><b>4D DESIGN</b></p> <p><b>MATT SURFACE</b></p> <p>Natural look</p>	<p><b>FULL RIGID CORE TECHNOLOGY</b></p> <p>Rigid</p> <hr/> <p>60 °C 140 °F Max.</p> <hr/> <p>The best stability</p> <hr/> <p>Renovation ceramic 6 mm joint</p>	<p><b>LOCK SYSTEM</b></p> <p>Standard laminate installation</p>
	<p><b>CRISTAL WEAR LAYER</b></p> <p>High definition design &amp; color</p>		
	<p><b>STRUCTURED EMBOSS &amp; BEVEL</b></p> <p>Ultra realistic surface</p>		
	<p><b>XL FORMAT</b></p> <p>Wide variety of tiles &amp; planks</p>		

Please refer to Gerflor's installation guidelines

### ▶ DESIGN SKIRTINGS

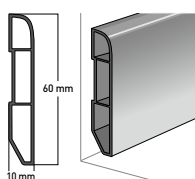

**Vinyl design skirting**  
Ref. 6086 + colour code  
**Design skirting caps**  
Ref. 6087 (see page 288 for further details)

- 60 mm high
- Suitable for areas up to 80 sqm
- 2 lm
- Packaging: 6 skirtings per box (12 lm)
- 100% watertight suitable for dry AND wet areas
- All designs available + paintable white

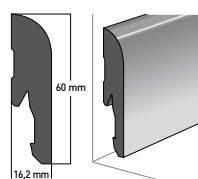

**MDF design skirting**  
Ref. 5947 + colour code

- 60 mm high / 16 mm thick
- Suitable for areas as from 80 sqm
- 2.2 lm
- Packaging: 5 skirtings per box (11 lm)
- Can be clipped (Gerflor clip: 5948), adhesived or nailed
- All designs available + paintable white

More details on [gerflor.com](http://gerflor.com)



# RIGID 30 LOCK

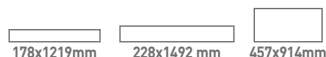
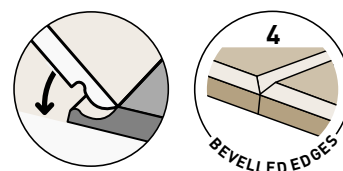

PUR+ Matt

100% recyclable

**RIGID 30 LOCK** is a synthetic, decorative, rigid, antistatic floorcovering, available in tiles and planks, with bevelled edges. It consists in a 0.30 mm thick transparent wear layer, a design film, a rigid core board technology. The overall thickness is 4 mm.

They benefit from a cross-linked polyurethane surface treatment (PUR+ MATT), making maintenance easier and eliminating the need for initial polishes.

**RIGID 30 LOCK** is a loose-lay floorcovering (up to 150 squared meters) assembled with a interlocking system, resistant to use (commercial / industrial use) of 23-31 according to EN-ISO 10874 and has Bfl-s1 class for smoke emission according to EN 13501-1.

**RIGID 30 LOCK** is phthalate free, except recycled content. It is 100% recyclable. It is 100% compliant with REACH. The product emission rate of organic compounds is < 100 microgram/m<sup>3</sup> (TVOC < 28 days - ISO 16000-6).

## RIGID 30 LOCK

DESCRIPTION					
Total thickness	EN ISO 24346	mm	4.00		
Thickness of wearlayer	EN ISO 24340	mm	0.30		
Weight	EN ISO 23997	g/sqm	7890		
Size	EN ISO 24342	mm	178 x 1219	228 x 1492	457 x 914
Number of planks /tiles and sqm per box	-	-	7 / 1.52	5 / 1.70	5 / 2.09
CLASSIFICATION					
Norm / Product specification	-	-	EN ISO 10582		
European classification	EN ISO 10874	class	23-31		
Fire rating	EN 13501-1	class	B <sub>fl</sub> -s1		
Static electrical propensity	EN 1815	kV	< 2		
Slip resistance wet	DIN 51 130	class	R10		
PERFORMANCES					
Wear resistance	EN 660.2	mm <sup>3</sup>	≤ 2.0		
Wear group	-	group	T		
Type Binder content	EN ISO 10582	type	I		
Room impact	NF S 31074	dB	80		
Impact sound insulation	EN ISO 717-2	dB	4		
Dimensional stability (norm)	EN ISO 23999	%	≤ 0.15		
Dimensional stability (average measured value)	-	%	≤ 0.08		
Residual indentation	EN ISO 24343-1	mm	≤ 0.10		
Castor chair test (type H)	ISO 4918	-	OK		
Thermal conductivity	EN ISO 10456	W/(m.k)	0.25		
Colour fastness	EN 20 105 - B02	degree	> 6		
Surface treatment	-	-	PUR+ Matt		
Chemical products resistance	EN ISO 26987	-	OK		
ENVIRONMENT / INDOOR AIR QUALITY					
TVOC after 28 days	ISO 16000-6	microgram/m <sup>3</sup>	< 100		
CE MARKING					
	EN 14041				

# LUXURY VINYL TILE

## RIGID 30 LOCK

178x1219mm 228x1492mm | PUR+ Matt | 100% recyclable



0017 Puno Pure

228 x 1492 mm



0004 Sucre

178 x 1219 mm



0002 Hobart

178 x 1219 mm



0008 Lovina

178 x 1219 mm



0015 Kilda Golden

228 x 1492 mm



0003 Viajo

178 x 1219 mm



0016 Puno Brown

228 x 1492 mm



0001 Puerto

178 x 1219 mm



0979 Crunchy

178 x 1219 mm

# RIGID 30 LOCK

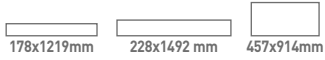
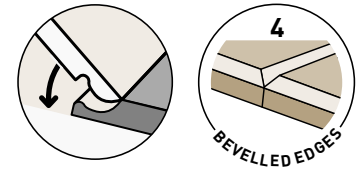

PUR+ Matt

100% recyclable



0007 Quito

178 x 1219 mm



0013 Bello

XL  
TILES

457 x 914 mm



0019 Kilda Pearl

228 x 1492 mm

XL  
PLANKS

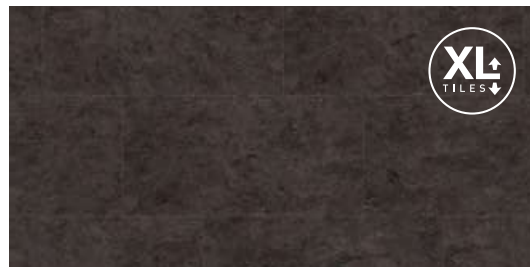

0011 Trondheim

XL  
TILES

457 x 914 mm



0010 Cartago

178 x 1219 mm



## CROSS REFERENCES / RIGID 30 LOCK & CREATION

CODE	RIGID	CREATION
0010	Cartago	Amador
0007	Quito	Arena / Denim Wood
0002	Hobart	Ballerina
0003	Viajo	Bostonian Oak
0009	Viajo Grey	Bostonian Grey
0013	Bello	Carmel / Dock Taupe
0016	Puno Brown	Cedar Brown
0017	Puno Pure	Cedar Pure
0011	Trondheim	Norwegian Stone / Welsh Slate
0001	Puerto	Quartet
0008	Lovina	Ranch
0015	Kilda Golden	Swiss Oak Golden
0019	Kilda Pearl	Swiss Oak Pearl
0004	Sucre	Twist / Midwest
0977	Suave Grey	Oxford
0979	Crunchy	Buffalo



0009 Viajo Grey

178 x 1219 mm



0977 Suave Grey

178 x 1219 mm



DESIGN SHADE VARIATION:



Light



Medium



High

Creation  
LVT



# LUXURY VINYL TILE

## TOPSILENCE DESIGN

### ▶ TOPSILENCE DESIGN

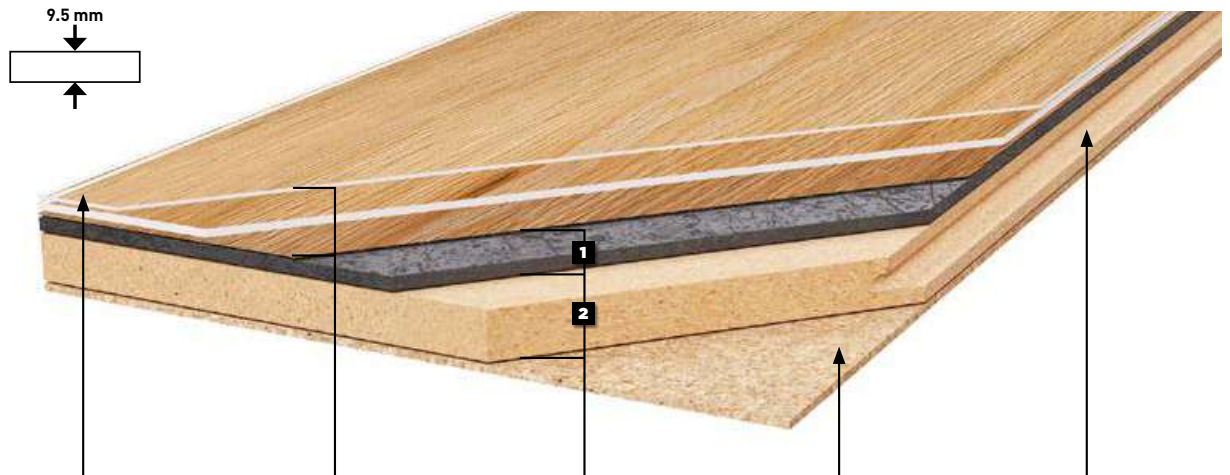

**PUR+ MATT**

Easy maintenance

**4D DESIGN**

**MATT SURFACE**

Natural look

**CRISTAL WEAR LAYER**

High definition design & color

**STRUCTURED EMBOSS & BEVEL**

Ultra realistic surface

**COLLECTION**

Wide variety of tiles & planks

**HYBRID TECHNOLOGY**

**1 RESILIENT COMFORT CORE**

Noise absorption

Soft underfoot

**2 WOOD CORE**

60 °C  
140 °F  
Max.

The best stability

Renovation ceramic < 6 mm joint

**NATURAL INSULATION**

**ACOUSTIC BACKING**

16 dB

**LOCK SYSTEM**

Standard laminate interlocking

Please refer to Gerflor's installation guidelines

### ▶ DESIGN SKIRTINGS

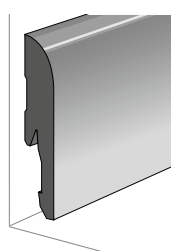
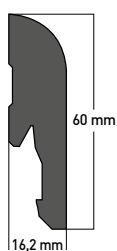

#### MDF design skirting - Ref. 5947 + colour code

- 60 mm high / 16 mm thick
- 2.2 lm
- Packaging: 5 skirtings per box (11 lm)
- Can be clipped (Gerflor clip: 5948), adhesived or nailed
- All designs available + paintable white

More details on [gerflor.com](http://gerflor.com)

# TOPSILENCE DESIGN

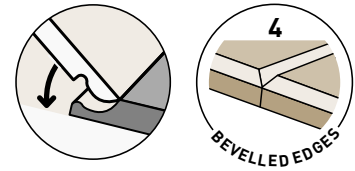

PUR+ Matt



**TOPSILENCE DESIGN** is a decorative floorcovering solution based on a Vinyl and HDF construction, available in tiles and planks, with bevelled edges. It consists of a wear layer, a design film, a PVC layer for a better walking comfort, a 6.8 mm HDF board for the stability and 1.2 mm Cork underlay allowing acoustic insulation up to 16 dB. The overall thickness is 9.5 mm. It benefits from a cross-linked polyurethane surface treatment (**PUR+ MATT**), making maintenance easier and eliminating the need for initial polishes.

**TOPSILENCE DESIGN** is an interlocking floorcovering assembled with an interlocking system, resistant to use (residential / commercial use) of 23-32 according to EN-ISO 16511 and has B<sub>fl</sub>-s1 class for smoke emission according to EN 13501-1.

**TOPSILENCE DESIGN** is phthalate free, except recycled content. It is REACH compliant. The product emission rate of organic compounds is < 100 microgram/m<sup>3</sup> (TVOC < 28 days – ISO 16000-6).

			TOPSILENCE DESIGN
<b>DESCRIPTION</b>			
Total thickness	EN ISO 24346	mm	9.5
Weight	EN ISO 23997	g/sqm	9880
Plank size	EN ISO 24342	mm	229 x 1235
Tile size	EN ISO 24342	mm	298 x 620
<b>CLASSIFICATION</b>			
Norm / Product specification	-	-	EN 16511
European classification	EN ISO 10874	class	32
Fire rating	EN 13501-1	class	B <sub>fl</sub> -s1
Static electrical propensity	EN 1815	kV	< 2
Slip resistance wet	DIN 51 130	class	R10
<b>PERFORMANCES</b>			
Impact sound insulation	EN ISO 717-2	dB	16
Dimensional stability	EN ISO 23999	%	≤ 0.15
Residual indentation	EN ISO 24343-1	mm	≤ 0.10
Castor chair test (type H)	ISO 4918	-	OK
Thermal conductivity	EN ISO 10456	W/(m.k)	0.25
Colour fastness	EN 20 105 - B02	degree	≥ 6
Surface treatment	-	-	PUR+ Matt
Chemical products resistance	EN ISO 26987	-	OK
<b>ENVIRONMENT / INDOOR AIR QUALITY</b>			
TVOC after 28 days	ISO 16000-6	microgram/m <sup>3</sup>	< 100
<b>CE MARKING</b>			
CE	EN 14041		

# LUXURY VINYL TILE

## TOPSILENCE DESIGN

229x1235 mm

298x620 mm

PUR+ Matt

100% recyclable



0007 Carvalho

229 x 1235 mm



0005 Sintra

229 x 1235 mm



0009 Arda Golden

229 x 1235 mm



0006 Ruivo Brown

229 x 1235 mm



0015 Braga

229 x 1235 mm

0005 Sintra



# TOPSILENCE DESIGN

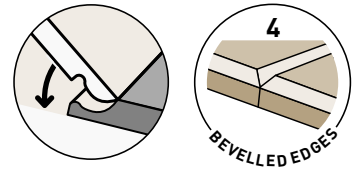

PUR+ Matt

100% recyclable



0011 Tavira Clear

229 x 1235 mm



0004 Peniche

229 x 1235 mm



0008 Estrela

229 x 1235 mm



0010 Arda Pearl

229 x 1235 mm



0003 Douro

229 x 1235 mm



0014 Montego Grey

229 x 1235 mm



0002 Minho

298 x 620 mm

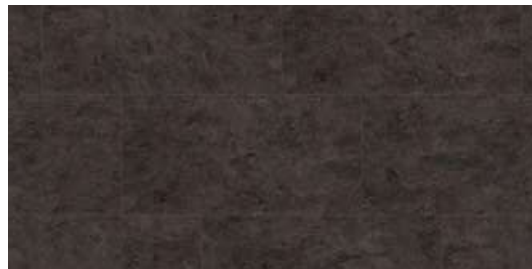

0001 Negra

298 x 620 mm



Creation  
LVT

## CROSS REFERENCES / TOPSILENCE DESIGN & CREATION 30

TOPSILENCE DESIGN	CREATION 30 GLUE DOWN / CLIC
Ruivo Brown 0006	Cedar Brown 0850
Sintra 0005	Ballerina 0347
Arda Golden 0009	Swiss Oak Golden 0796
Braga 0015	Buffalo 0457
Tavira Clear 0011	Twist 0504
Carvalho 0007	Malua Bay 0448
Peniche 0004	Arena 0060

TOPSILENCE DESIGN	CREATION 30 GLUE DOWN / CLIC
Arda Pearl 0010	Swiss Oak Pearl 0846
Estrela 0008	Ranch 0456
Douro 0003	Amador 0447
Montego Grey 0014	Oxford 0061
Negra 0001	Norwegian Stone 0860
Minho 0002	Carmel 0618

DESIGN SHADE VARIATION:



Light



Medium



High

# LUXURY VINYL TILE

## MORE THAN A FLOOR... WALL & FINISHES



### PROFILES

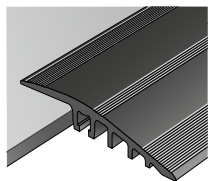

**RAMP 5-6MM**  
(aluminium)  
Ref. 0505



**FLAT THRESHOLD\***  
(aluminium)  
Ref. 2570

Suitable with Creation  
Clic and Looselay

### DESIGN SKIRTINGS

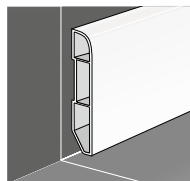

Ref. 6086 + Color code  
(Vinyl)

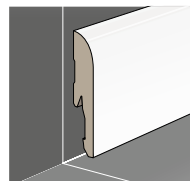

Ref. 5947 + Color code  
(MDF)

**+ END CAPS**

Ref. 6087 (1 color anthracite grey)

White to paint or matching design  
pages 123, 144, 164

### COVERING SKIRTING

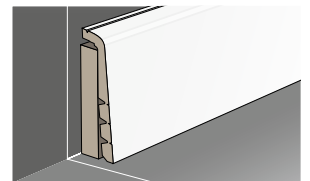

Ref. 2550\*  
(MDF)



**TOOLS**



**ADD-ON UNDERLAYERS**



Creation  
LVT

**FOR MORE DETAILS**

visit [gerflor.com](http://gerflor.com)  
> Services > Virtual Library



**SPECIAL LVT FINISHING  
BROCHURE AVAILABLE**

**MATTING**

**3 TRAFFIC LEVELS**



**QUICKMAT TILES**

Ref. 1725 + 1726 + 1727



**LOOSELAY ROMAT GT  
INSERT KIT**

Ref. 1719



**KIT ESPLANADE 9000**

Ref. 1700

Suitable with Creation Clic and Looselay

**COMPLETE RANGE  
OF ACCESSORIES  
page 282-313**





.....

# TECHNICAL TILES

..... PAGES .....

# 176/191

.....





**GTI ..... 180-187**

- GTI MAX 180-183
- GTI EL5 184-187

**Attraction® ..... 188-191**

# TECHNICAL TILES

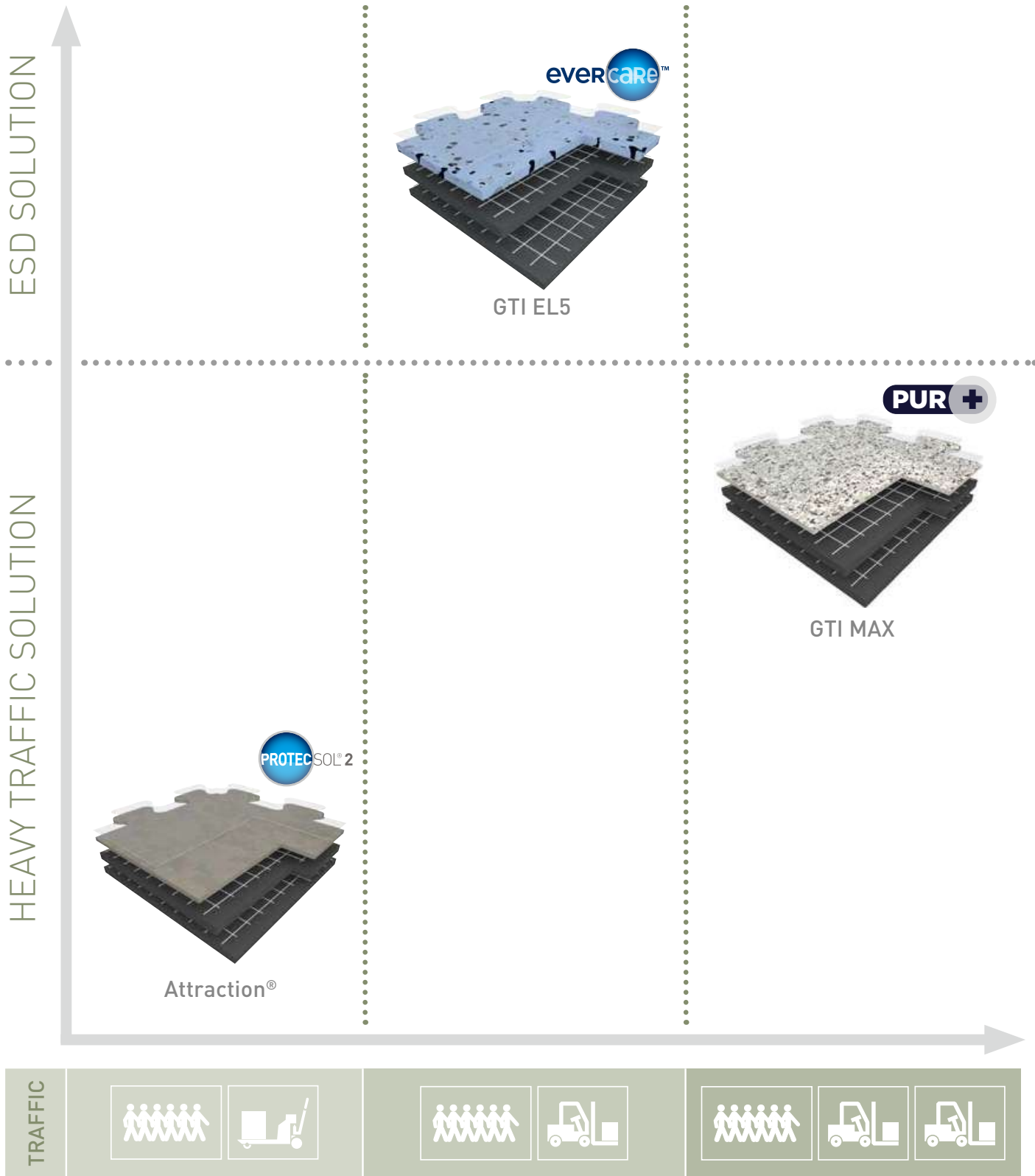



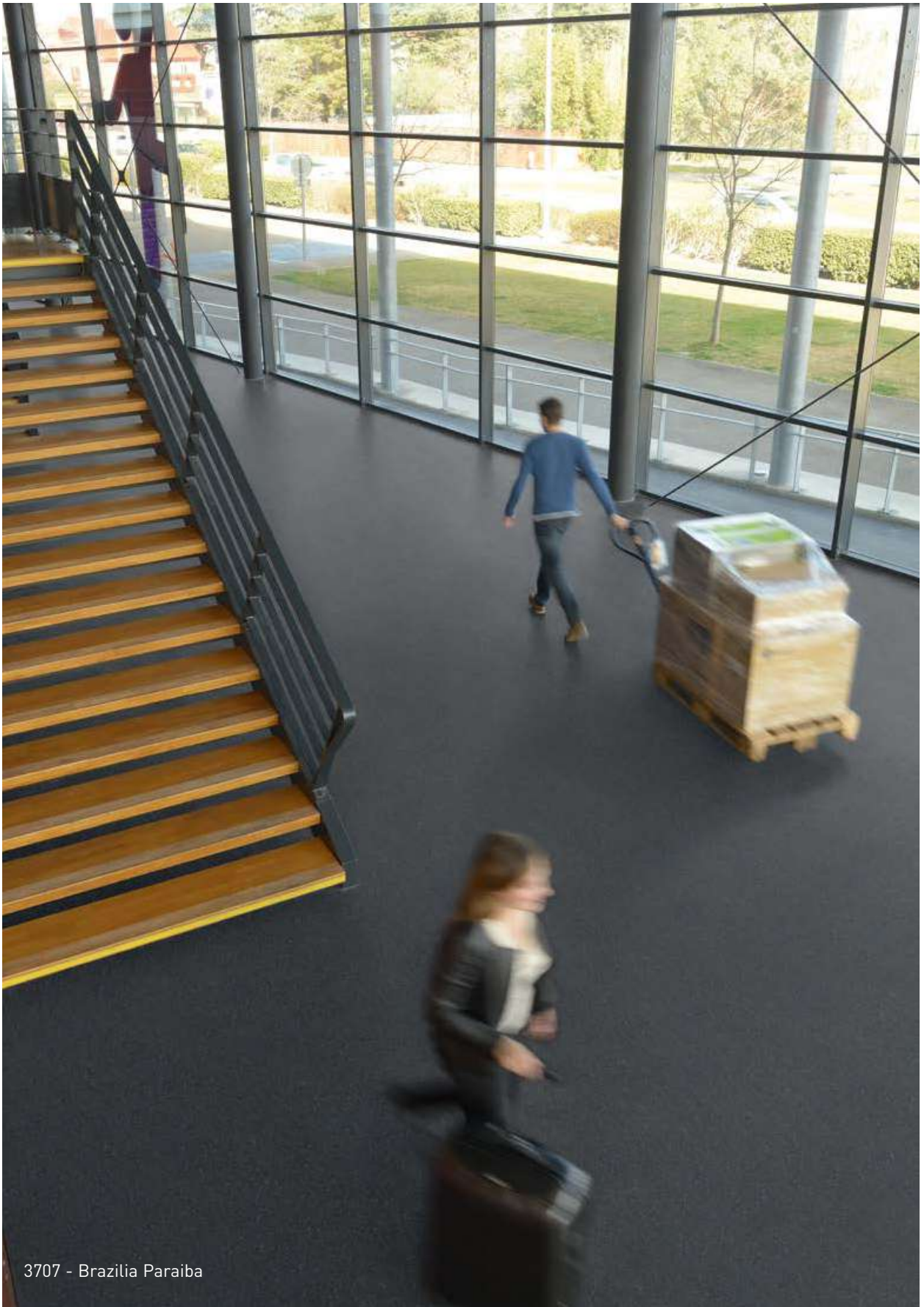

3707 - Brazilia Paraiba

Technical  
tiles

# TECHNICAL TILES

## GTI MAX

### ▶ GTI MAX CONNECT & CLEANTECH

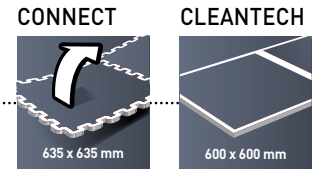

#### GTI CONNECT

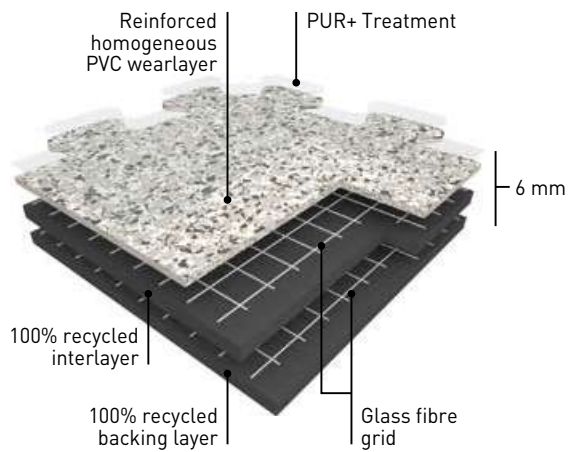

#### GTI CLEANTECH

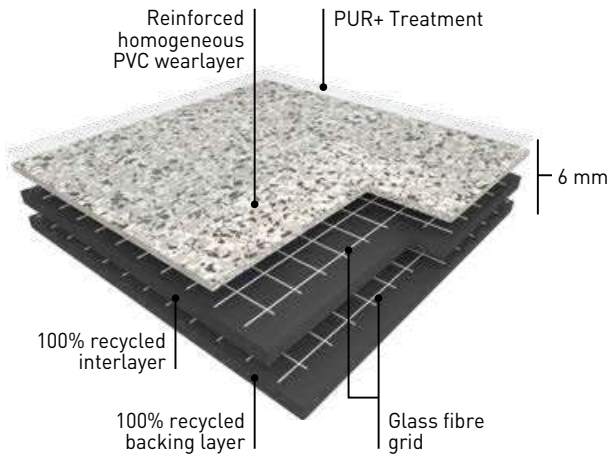

**GTI MAX** is a multi-layered interlocking looselay vinyl tile with polyurethane treatment (**PUR+**), 6 mm thick with a dovetail joint for the **CONNECT** configuration and with welded joints for the **CLEANTECH** configuration.

GTI is manufactured by Gerflor using a continuous high pressure process, abrasion group T. The **GTI MAX** wearlayer is reinforced by specific oblong fillers that offers an outstanding resistance to traffic.

**GTI MAX** is reinforced with 2 glass fibre grids on either side of an intermediate pressed homogeneous layer.

**GTI MAX** backing is a 4 mm thick black pressed homogeneous sheet, its surface is a coloured and reinforced homogeneous sheet 2 mm thick. The product is 100% recyclable.

**GTI MAX** is made with a phthalate free plasticizer.

**GTI Access** are ramps that provide continuity between the tile and the existing floor.

**GTI Corner** enable covering of inaccessible corners or finishing central patterns.

#### GTI LOGOS



# GTI MAX



Removable

R10

PUR+



- ▶ **Resistant to heavy traffic**
- ▶ **Fast renovation: can be installed over existing floorcovering**
- ▶ **No subfloor preparation, no adhesive and no production stop (no loss of money)**
- ▶ **Polyurethane surface treatment PUR+ for ease of maintenance**
- ▶ **6 Standard logos: Mix and match colours to create corners and walkways**

	TEST METHOD		GTI MAX	
<b>DESCRIPTION</b>				
Total thickness	-	EN ISO 24346	mm	6
Wearlayer thickness	-	EN ISO 24340	mm	2
Weight	-	EN ISO 23997	g/m <sup>2</sup>	9365
Size	-	EN ISO 24342	mm	635 x 635 GTI CONNECT 600 x 600 GTI CLEANTECH (without dovetail) <sup>(1)</sup>
<b>CLASSIFICATION</b>				
Norm / Product specification	-	-	-	EN ISO 10582
European classification	-	EN ISO 10874	class	34-43
Fire rating	-	EN 13501-1	class	Bfl-s1
Static electrical propensity	EN 1815	EN 14041	kV	< 2
Slip resistance wet: ramp test with oil	DIN 51 130	-	class	R10
Pendulum test	-	BS7976	-	Concrete emboss <sup>(2)</sup> : PTV+ 36 compliant   Rice emboss <sup>(2)</sup> : NO
<b>PERFORMANCES</b>				
Wear resistance	-	EN 660.2	mm <sup>3</sup>	≤ 2.0
Wear group	-	-	group	T
Type Binder content	-	EN ISO 10582	type	I
Dimensional stability	-	EN ISO 23999	%	≤ 0.15
Residual indentation	-	EN ISO 24343-1	mm	≤ 0.10
Castor chair test (type W)	-	ISO 4918	-	OK
Shore Hardness	-	EN ISO 868	H <sub>b</sub>	≥ 55
Shifting resistance	-	CAHIER CSTB 3562	N/mm <sup>2</sup>	≥ 30
Thermal conductivity	-	EN ISO 10456	W/(m.k)	0.25
Colour fastness	-	EN 20 105 - B02	degree	≥ 6
Surface treatment	-	-	-	PUR+
Chemical products resistance	-	EN ISO 26987	-	OK
<b>ENVIRONMENT / INDOOR AIR QUALITY</b>				
TVOC after 28 days	-	ISO 16000-6	microgram/m <sup>3</sup>	< 100
Certification	-	-	-	Floorscore®
<b>CE MARKING</b>				
CE	EN 14041			

(1) Available upon request

(2) See pages 182-183



# TECHNICAL TILES

## GTI MAX - Rice Emboss

  **Removable** | **R10** | **PUR+** |  **100% recyclable**

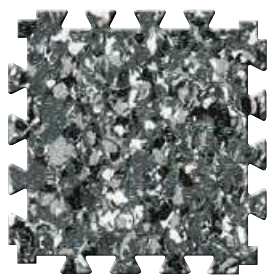

0249 - Carbon

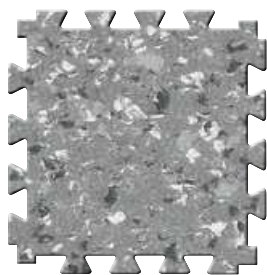

0266 - Peler

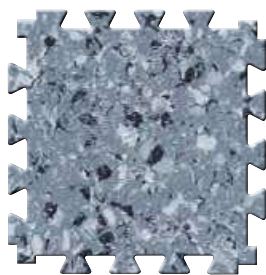

0252 - Titanium



0253 - Aluminium

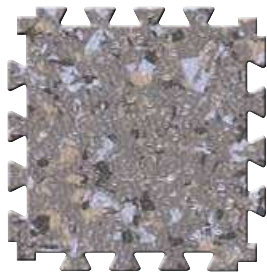

0247 - Magma

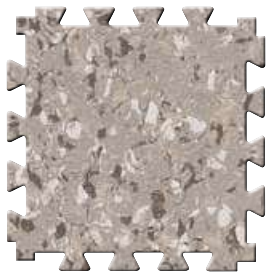

0267 - Levante

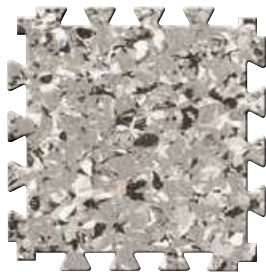

0264 - Ponente



0265 - Maestrale

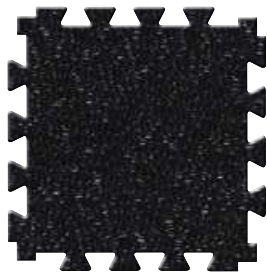

0236 - Black

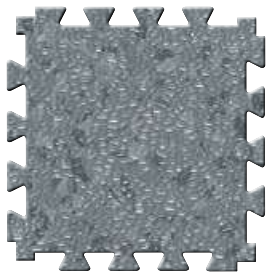

0235 - Dark Grey

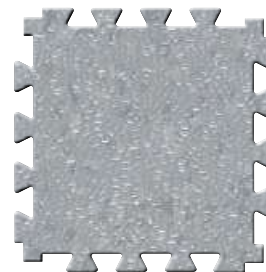

0234 - Clear Grey

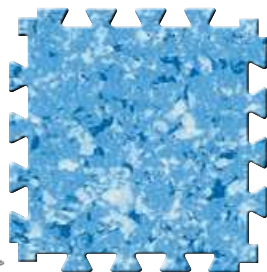

0255 - Saphir

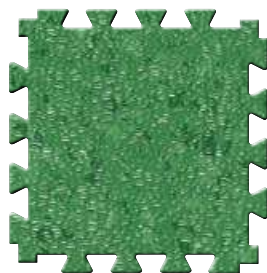

0233 - Green

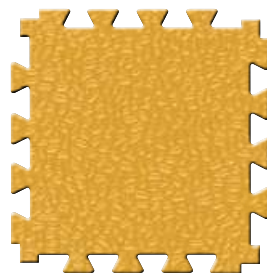

0244 - Yellow

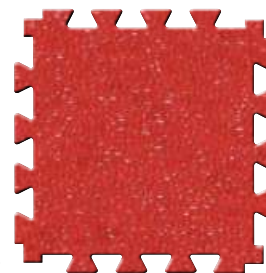

0232 - Red

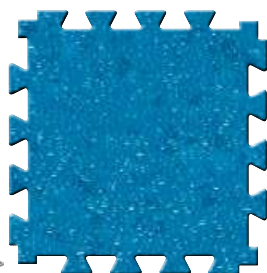

0230 - Blue

15 interlocking edges per side

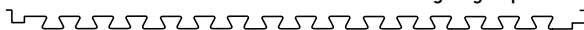

All these colours are available in GTI MAX CLEANTECH.  
For more details please contact your Gerflor representative.

# GTI MAX - Concrete Emboss



Removable

R10

PUR+

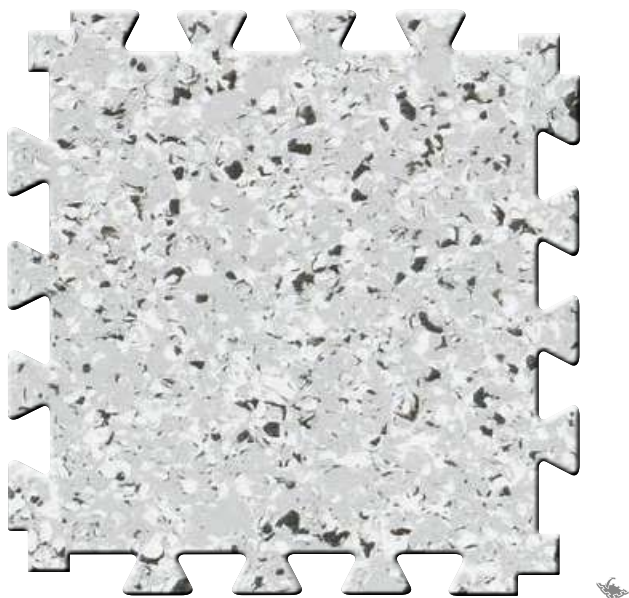

0268 - Ermellino

^ Scale 1

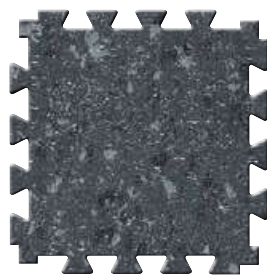

0260 - Ora

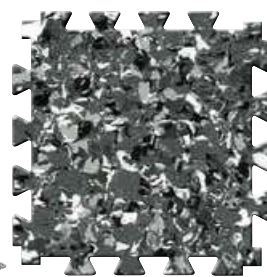

1249 - Tramontana



0262 - Libeccio

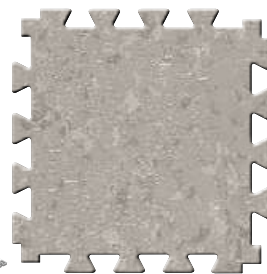

0263 - Bora



0268 Ermellino

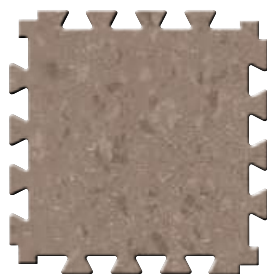

0261 - Scirocco

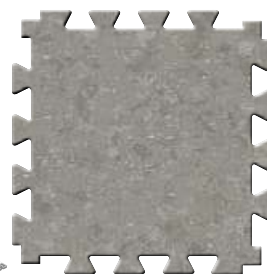

0259 - Grecale

Technical tiles

## ACCESSORIES GTI MAX

ALUMINIUM RAMP 5-6 MM

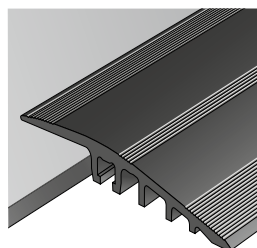

Aluminium Ramp 5-6 mm /  
Ref. 0505  
+ Aluminium Corner 5-6 mm /  
Ref. 1513  
See page 294

HIGH TRAFIC PVC RAMP 6 MM

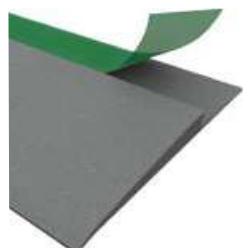

Ref. 0500  
See page 293

KIT ESPLANADE 9000



Ref. 1700  
See page 297

CORNER & ACCESS

GTI CORNER CONNECT  
320 x 320 mm



GTI ACCESS CONNECT  
635 x 320 mm



GTI CORNER CLEANTECH  
300 x 300 mm

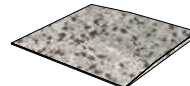

GTI ACCESS CLEANTECH  
600 x 300 mm

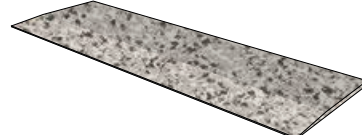

For more information, please refer to our GTI MAX brochure.



# TECHNICAL TILES

## GTI EL5

### ▶ GTI EL5 CONNECT & CLEANTECH

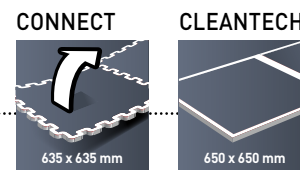

#### GTI EL5 CONNECT

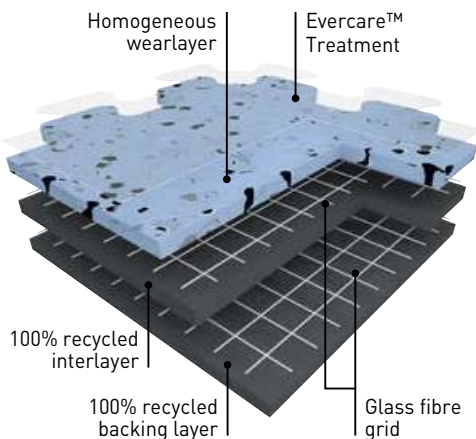

**GTI EL5 CONNECT** is a multi-layered looselay vinyl tile, 6 mm thick, reinforced with 2 glass fibre grids. GTI EL5 CONNECT tiles can be installed using interlocking system with dove tails.

**GTI EL5 CLEANTECH** is a multi-layered looselay vinyl tile, 6 mm thick, reinforced with 2 glass fibre grids. GTI EL5 CLEANTECH is available in **square format with welded joints** for clean environments and watertight systems requirements.

**GTI EL5** wearlayer is 2 mm vinyl homogeneous manufactured with continuous high pressure process, abrasion group P. It offers an outstanding resistance to traffic.

This floorcovering is treated with **Evercare™** technology: the latest improvements in polyurethane surface treatment obtained by UV laser cross-linking. Evercare™ offers **easy maintenance and resistance against staining** of chemical products used in healthcare like betadine, eosin or anti-bacterial hand gel; **and decontamination protocols**.

This treatment has excellent maintenance characteristics; it requires no wax for life!

The carbon encapsulated granules throughout its full thickness and the **conductive backing** and **conductive surface treatment** ensure optimal and consistent conductive properties throughout its full life expectancy.

- $5 \times 10^4 \leq Rt \leq 10^6$  according to **EN 1081**

It has permanent antistatic properties.

- **< 2000 V** according to **EN 1815**

**The product is non-emissive of volatile organic compounds with < 10 microgram/m<sup>3</sup> (TVOC after 28 days ISO 16000-6).**

#### GTI EL5 CLEANTECH

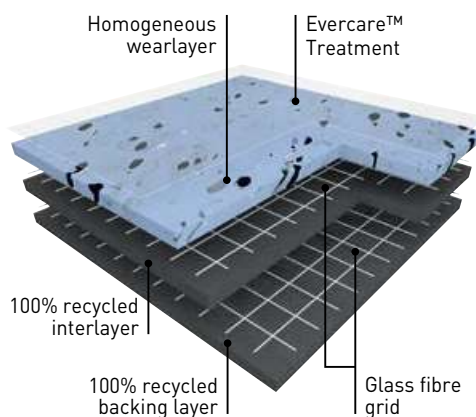

#### COMPLEMENTARY FINISHES

GTI EL5 CONNECT		GTI EL5 CLEANTECH	
2717	Access	2715	Access
		2716	Corner
		2722	Conductive Welding Rods
2718	Corner	2719	Coving
		2720	Coving Corner In
		2721	Coving Corner Out





# GTI EL5



Removable

R9

Evercare™



## CONNECT

- ▶ Fast Installation
- ▶ Resistance to heavy traffic

## CLEANTECH

- ▶ Watertight System (hot welding)
- ▶ Resistance to heavy traffic

			GTI EL5
<b>DESCRIPTION</b>			
Total thickness	EN ISO 24346	mm	6
Wearlayer thickness	EN ISO 24340	mm	2
Weight	EN ISO 23997	g/m <sup>2</sup>	9240
Size	EN ISO 24342	mm	635 x 635 (GTI EL5 CONNECT) 650 x 650 (GTI EL5 CLEANTECH)
<b>CLASSIFICATION</b>			
Norm / Product specification	-	-	EN ISO 10582
European classification	EN ISO 10874	class	34-43
Fire rating	EN 13501-1	class	Bfl-s1
Electrical resistance <sup>(1)</sup>	EN 1081	W	Rg 10 <sup>6</sup>
Static electrical propensity	EN 1815	kV	< 2
Slip resistance wet: ramp test with oil	DIN 51 130	class	R9
<b>PERFORMANCES</b>			
Wear resistance	EN 660.2	mm <sup>3</sup>	≤ 4.0
Wear group	NF 189	group	P
Type Binder content	EN ISO 10582	type	I
Dimensional stability	EN ISO 23999	%	≤ 0.25
Castor chair test (type W)	ISO 4918	-	OK
Shore Hardness	EN ISO 868	H <sub>D</sub>	≥ 90
Thermal conductivity	EN ISO 10456	W/(m.k)	0.25
Colour fastness	EN 20 105 - B02	degree	≥ 6
Surface treatment	-	-	Evercare™
Chemical products resistance	EN ISO 26987	-	OK
<b>ENVIRONMENT / INDOOR AIR QUALITY</b>			
TVOC after 28 days	ISO 16000-6	microgram/m <sup>3</sup>	< 10
Certification	-	-	Floorscore®
<b>CE MARKING</b>			
	EN 14041		

(1) Measured before installation

# TECHNICAL TILES

GTI EL5



GTI CLEANTECH - 0354 Blue

# GTI EL5

## GTI EL5 CONNECT

Compact  
CONNECT  
635 x 635 mm

R9 | Evercare™ | Removable



0353 Beige

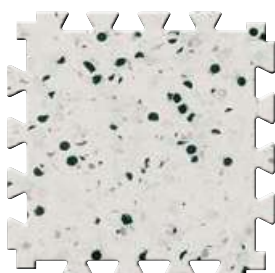

0350 Light Grey

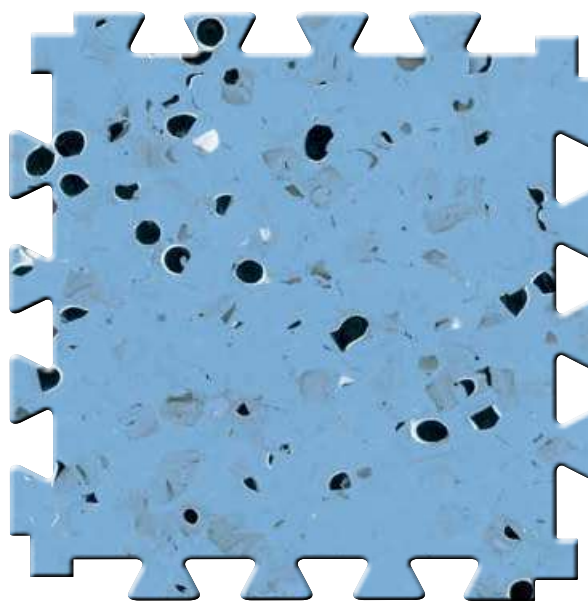

0354 Blue

^ Scale 1



0352 Grey

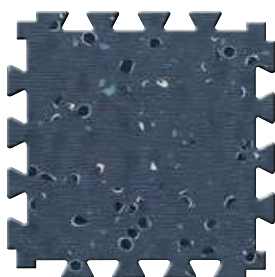

0351 Black

## GTI EL5 CLEANTECH

Compact  
CLEANTECH  
650 x 650 mm

R9 | Evercare™ | Removable

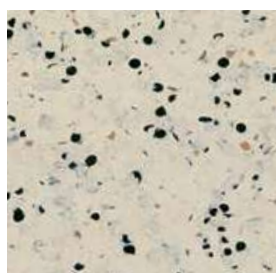
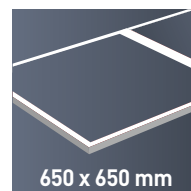

0353 Beige

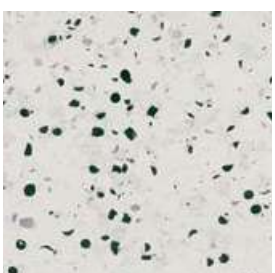

0350 Light Grey

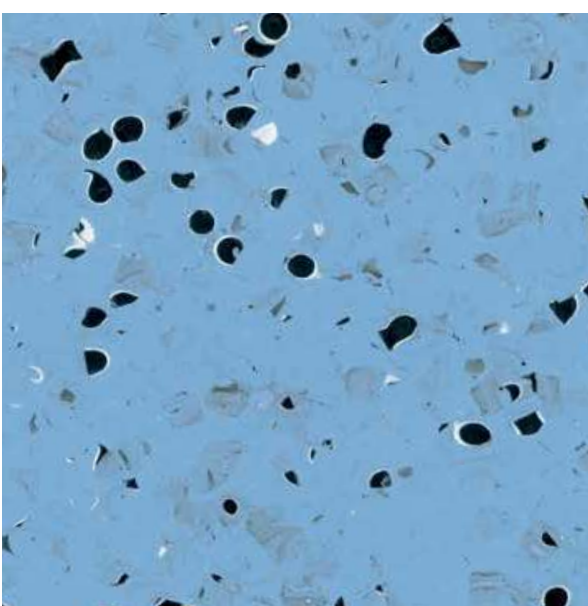

0354 Blue

^ Scale 1

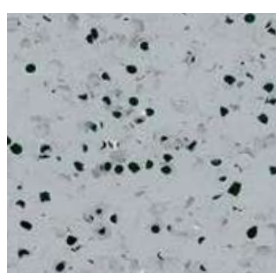

0352 Grey

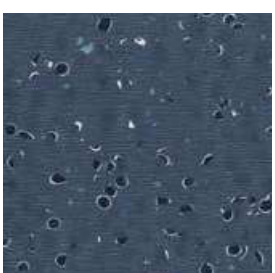

0351 Black

Technical  
tiles



# TECHNICAL TILES

## ATTRACTION®

### ▶ ATTRACTION® CONNECT & CLEANTECH

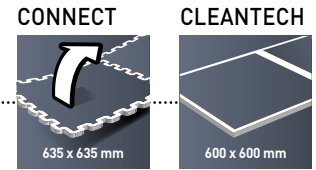

#### ATTRACTION® CONNECT

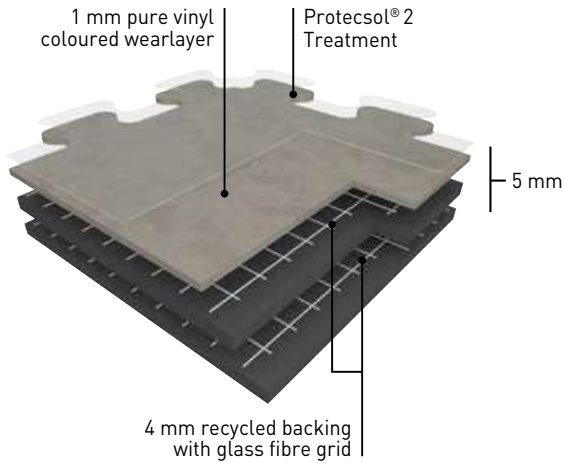

ATTRACTION® is a semi-flexible tile constructed by compacting, at high temperature and over 3000 T, a 4 mm recycled backing and a 1 mm **pure vinyl wear layer**. **This wear layer is incorporating very densely pressed coloured chips, with a mat finishing and without a transparent wear layer.** The product comprises a compact backing which is pressed and reinforced with two glass fibre grids.

ATTRACTION® has a unique dovetail joint which allows fast loose lay installation and replacement.

ATTRACTION® is treated with **Protecsol® 2**, a surface treatment obtained by UV laser crosslinking.

This **Protecsol® 2** ensures easy maintenance and eliminates permanently the need for acrylic emulsion (metallisation). It avoids staining of chemical products used in healthcare like iodine alcohol, Betadine, eosin and anti-bacterial hand gel.

It has a Bfl-s1 fire classification in accordance with standard EN 13501-1. The products emission rate of volatile organic compounds is **< 10 microgram/m³ (TVOC after 28 days – ISO 16000-6)**.

It is made with a phthalate free plasticizer.

It is made of 100% controlled recycled materials.

It does not contain any heavy metals or CMR 1&2 and they are 100% compliant with REACH.

It is 100% recyclable and made with up to 80% recycled content.

#### ATTRACTION® CLEANTECH

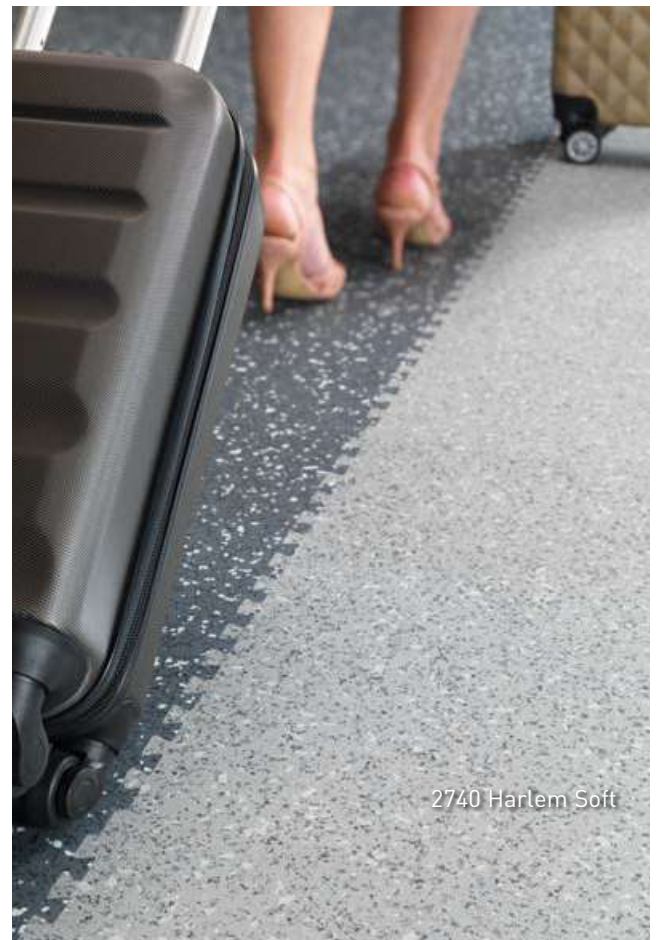
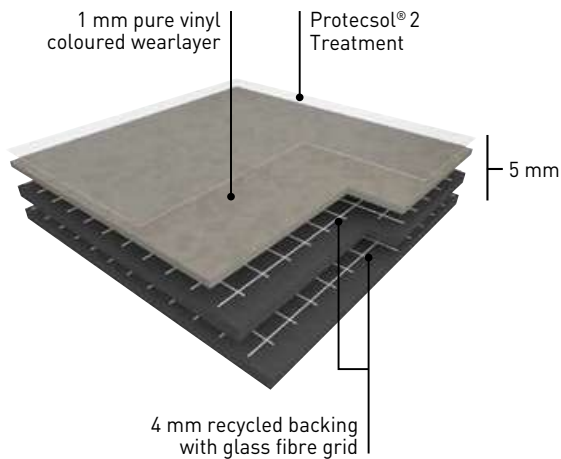

2740 Harlem Soft

# ATTRACTION®



Removable

R10

Protecsol® 2



The Taralay Premium range in the looselay Attraction® format for an easy and longlasting renovation!

- ▶ Fast track and easy installation
- ▶ No immobilisation of the premises and no loss of turnover
- ▶ Little or no subfloor preparation
- ▶ Low maintenance cost: UV cured polyurethane Protecsol® 2 treatment.

			ATTRACTION®
DESCRIPTION			
Total thickness	EN ISO 24346	mm	5.00
Wearlayer thickness	EN ISO 24340	mm	1.00
Weight	EN ISO 23997	g/m <sup>2</sup>	7460
Size	EN ISO 24342	mm	635 x 635 CONNECT 600 x 600 CLEANTECH (without dovetail) <sup>(1)</sup>
CLASSIFICATION			
Norm / Product specification	-	-	EN ISO 10582
European classification	EN ISO 10874	class	34-43
Fire rating	EN 13501-1	class	Bfl-s1
Static electrical propensity	EN 1815 IEC 61340-4-5	kV V	< 2
Slip resistance wet: ramp test with oil	DIN 51 130	class	R10
PERFORMANCES			
Wear resistance	EN 660.2	mm <sup>3</sup>	≤ 2.0
Wear group	-	group	T
Type Binder content	EN ISO 10582	type	I
Dimensional stability	EN ISO 23999	%	≤ 0.25
Residual indentation	EN ISO 24343-1	mm	≤ 0.10
Castor chair test (type W)	ISO 4918	-	OK
Thermal conductivity	EN ISO 10456	W/(m.k)	0.25
Colour fastness	EN 20 105 - B02	degree	≥ 6
Surface treatment	-	-	Protecsol® 2
Chemical products resistance	EN ISO 26987	-	OK
ENVIRONMENT / INDOOR AIR QUALITY			
TVOC after 28 days	ISO 16000-6	microgram/m <sup>3</sup>	< 10
Certification	-	-	Floorscore®
CE MARKING			
CE	EN 14041		

(1) Available upon request

# TECHNICAL TILES

## ATTRACTION®

 Compact CONNECT 635 x 635 mm	 Compact CLEANTECH 600 x 600 mm	Removable	R10	Protocols® 2	 100% recyclable
---	---	-----------	-----	--------------	---



8386 Boa Vista (Brazilia)

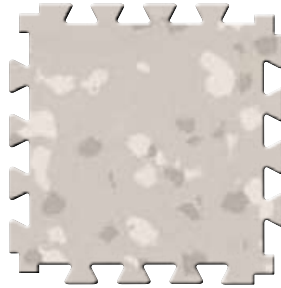

4342 Juara (Brazilia)

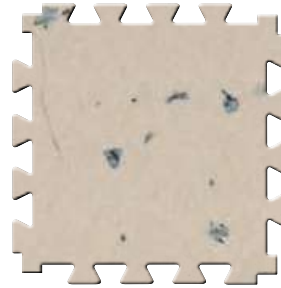

4343 Tokelau (Indiana)

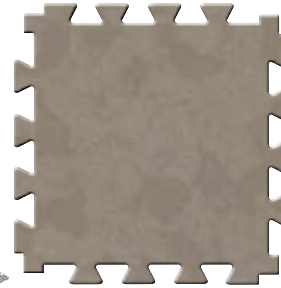

4351 Greige (Osmoz)



8736 Recife (Brazilia)

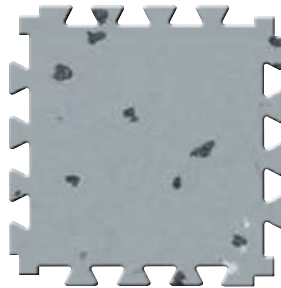

4003 Tao (Indiana)

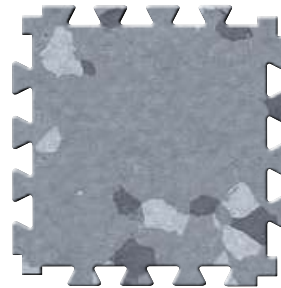

3709 Ceara (Brazilia)



8053 Anambas (Indiana)



4004 Pago (Indiana)

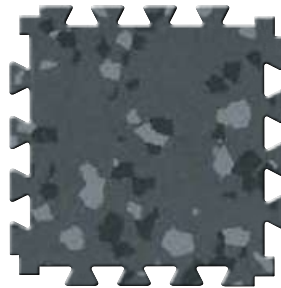

3707 Paraiba (Brazilia)

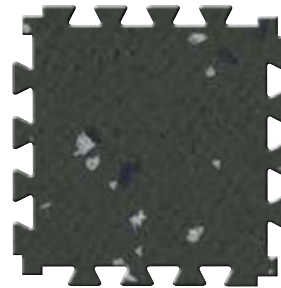

8837 Songo (Indiana)



635 mm

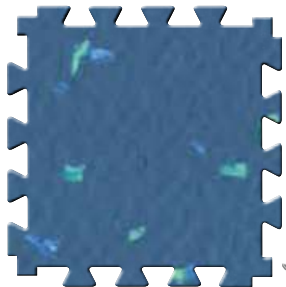

4476 Wattaru (Indiana)

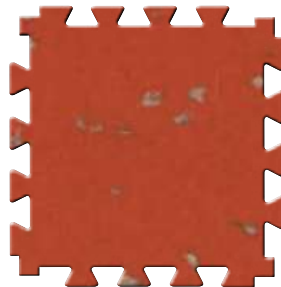

4146 Moheli (Indiana)

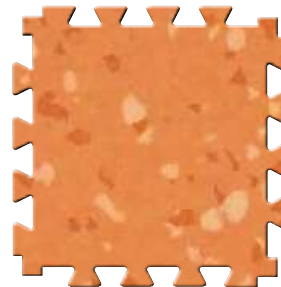

8157 Goias (Brazilia)

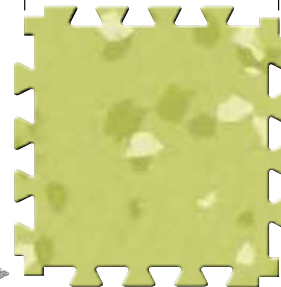

8577 Amazonas (Brazilia)

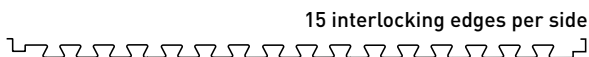

15 interlocking edges per side

All these colours are available in ATTRACTION® CLEANTECH.  
For more details please contact your Gerflor representative.



# ATTRACTION® - NEOPOLIS

Compact  
CONNECT  
635 x 635 mm

Compact  
CLEANTECH  
600 x 600 mm

Removable

R10

Protocolsol® 2

100% recyclable

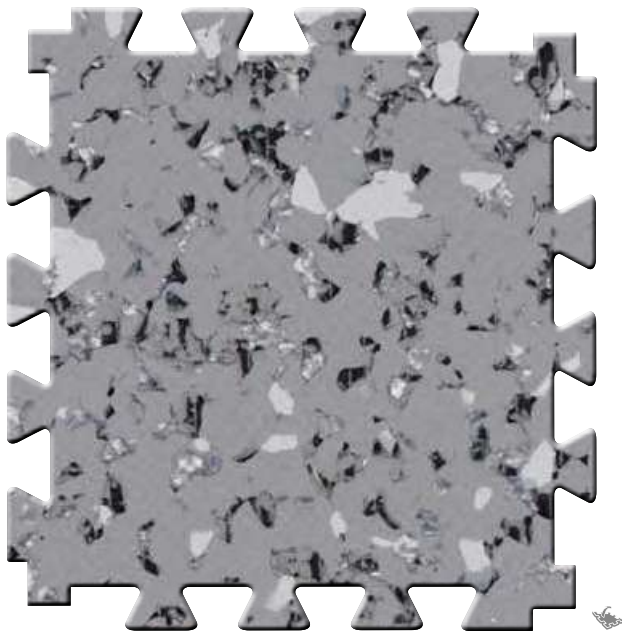

2740 Harlem Soft (Neopolis)

^ Scale 1

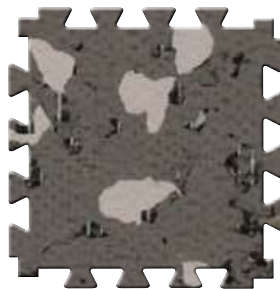

2742 Times Square (Neopolis)

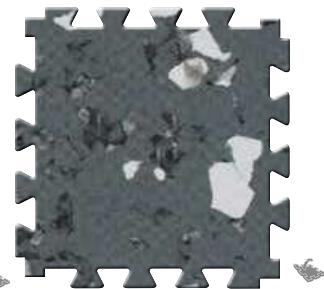

2741 Brooklyn (Neopolis)



2743 Central Park (Neopolis)



2744 Queens Soft (Neopolis)



2740 Harlem Soft



2745 Plaza (Neopolis)

Technical  
tiles

## ACCESSORIES ATTRACTION®

### ALUMINIUM RAMP 5-6 MM

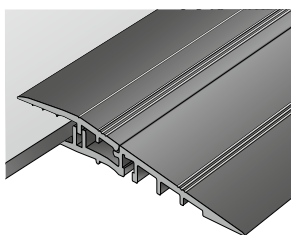

Aluminium Ramp 5-6 mm /  
Ref. 0609  
+ ALUMINIUM CORNER 5-6 mm /  
Ref. 0629  
See page 294

### KIT ROMAT GT FOR ATTRACTION®



Ref. 1719  
See page 297

### CORNER & ACCESS

ATTRACTION®  
CORNER  
CONNECT  
320 x 320 mm

ATTRACTION®  
ACCESS  
CONNECT  
635 x 320 mm

ATTRACTION®  
CORNER  
CLEANTECH  
300 x 300 mm

ATTRACTION®  
ACCESS  
CLEANTECH  
600 x 300 mm

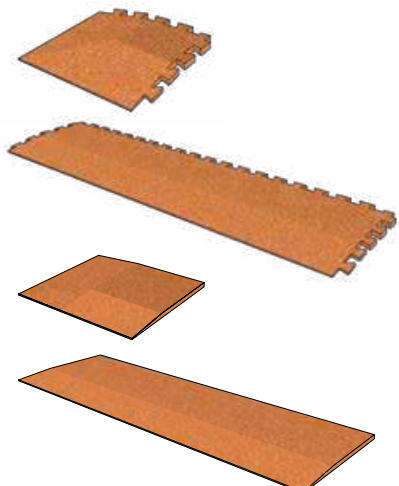

For more information, please refer to our Attraction® brochure.

A modern bathroom with a shower, sink, and towel rack. The shower has a silver showerhead and a glass door. The sink is white with a black countertop. A towel rack holds two white towels. A blue soap dispenser is on the wall. The floor is made of large, light-colored tiles. A pair of white slippers is on the floor near the shower.

TECHNICAL  
SOLUTIONS

PAGES

**192/215**



## EL5 / EL7 solutions

Dissipative & conductive floors .....196-199

### Dissipative floors

- Mipolam EL7 198
- Mipolam Robust EL7 198

### Conductive floors

- Mipolam EL5 199
- Mipolam Technic EL5 199
- GTI EL5 (See page 184)

## Safety floorings.....200-205

- Tarasafe Geo SparClean® 203
- Tarasafe Ultra & Ultra Comfort SparClean® 204
- Tarasafe Standard/Plus/Super 205
- Tarasafe Ultra H<sub>2</sub>O (See page 209)

## Shower System.....206-211

- Elegance SD 208
- Tarasafe Ultra H<sub>2</sub>O 209
- Mural Calypso 210

## Wallcoverings .....212-215

- Mural Ultra 214
- Mural Club 215
- Mural Calypso (See page 210)



# TECHNICAL SOLUTIONS

EL5 / EL7  
SOLUTIONS

## Dissipative Floors

EN 1081 ( $\Omega$ ):  $10^6 \leq Rt \leq 10^8$

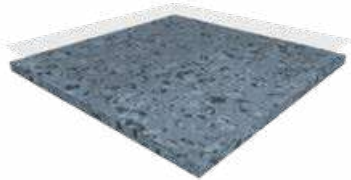

Mipolam EL7

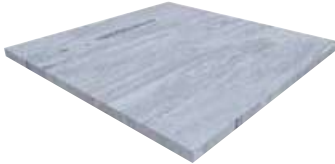

Mipolam Robust EL7

SLIP RESISTANT  
FLOORINGS

## SparClean® Treatment

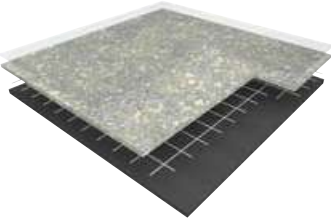

Tarasafe Geo /  
Tarasafe Ultra

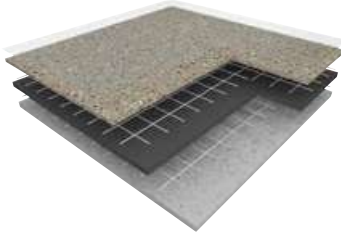

Tarasafe Ultra Comfort

SHOWER  
SYSTEM

## Floorcoverings



Elegance SD

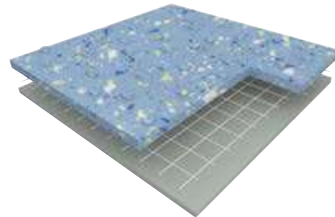

Tarasafe Ultra H<sub>2</sub>O

WALLCOVERINGS

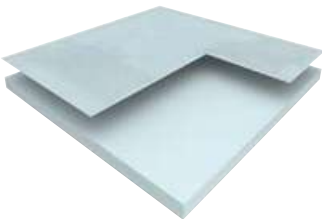

Mural Calypso



Mural Club

---

---

## Conductive Floors

EN 1081 ( $\Omega$ ):  $10^4 \leq R_t \leq 10^6$



Mipolam EL5

EN 1081 ( $\Omega$ ):  $10^4 \leq R_t \leq 10^6$

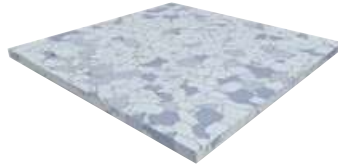

Mipolam Technic EL5

EN 1081 ( $\Omega$ ):  $5 \times 10^4 \leq R_t \leq 10^6$

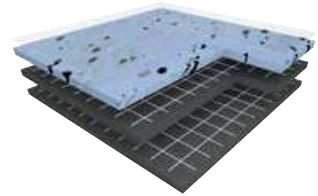

GTI EL5

---

---

## PUR Treatment

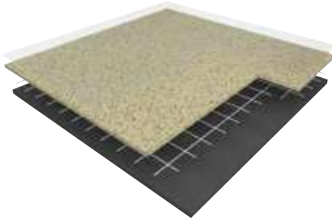

Tarasafe Standard

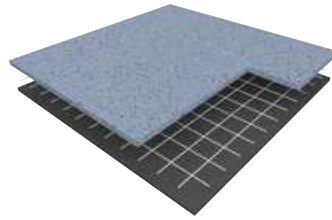

Tarasafe Super

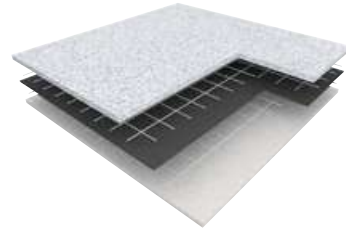

Tarasafe Plus

---

---

## Wallcoverings

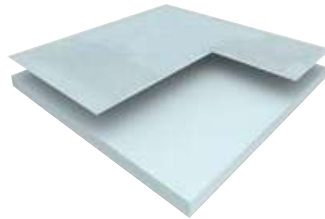

Mural Calypso

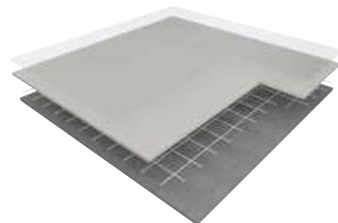

Mural Ultra

# TECHNICAL SOLUTIONS

## EL5 / EL7 SOLUTIONS

### Dissipative floors

#### ▶ MIPOLAM EL7 - MIPOLAM ROBUST EL7

MIPOLAM EL7

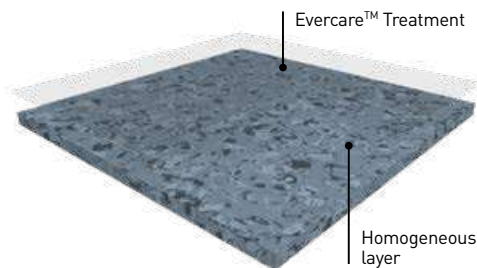

MIPOLAM ROBUST EL7

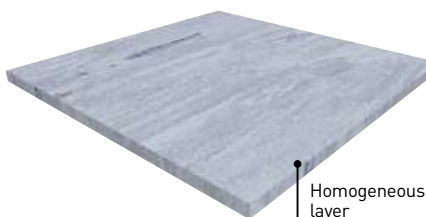

**MIPOLAM EL7** is a dissipative flexible homogeneous vinyl floorcovering available in both sheet and tile form, calendered and compacted and comes in 10 colours. This floorcovering is treated with **EVERCARE™**: the latest improvements in polyurethane surface treatment obtained by UV laser cross-linking. Evercare™ avoids stain of chemical products used in healthcare like betadine, eosin or anti-bacterial hand gel and increases the durability of the flooring. According to ISO 21702, **MIPOLAM EL7** has **anti-viral activity** against Human Coronaviruses: it reduces the number of virus by 99.7% after 2h. According to ISO 22196, **MIPOLAM EL7** has **anti-bacterial activity** against E. coli, S. aureus and MRSA of 99% after 24h. This treatment has excellent maintenance characteristics; it requires no wax for life! **MIPOLAM EL7** acts as a continuous dissipater  $10^6 \leq Rt \leq 10^8$ . The product has to be grounded with an ESD copper strip [see finishes] to meet its full performance. The product is non-reactive to residual indentation with a value  $\leq 0.02$  mm. The flooring has a binder content type II, is suitable for heavy duty traffic areas and has a Bfl-s1 fire resistance. The product is non-emissive of volatile organic compounds with  $<10$  microgram/m<sup>3</sup> (TVOC after 28 days ISO 16000-6).



**MIPOLAM ROBUST EL7** is a dissipative flexible homogeneous vinyl floorcovering available in both sheet and tile. Calendered and compacted. It acts as a continuous dissipater  $10^6 \leq Rt \leq 10^8$  (EN 1081).

### Conductive floors

#### ▶ MIPOLAM EL5 - MIPOLAM TECHNIC EL5



MIPOLAM EL5

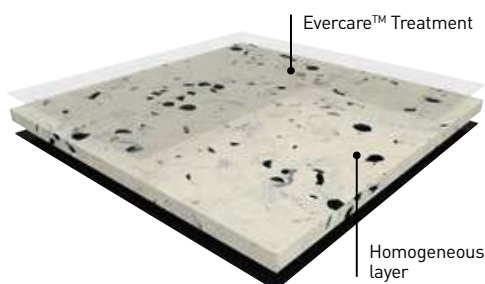

MIPOLAM TECHNIC EL5

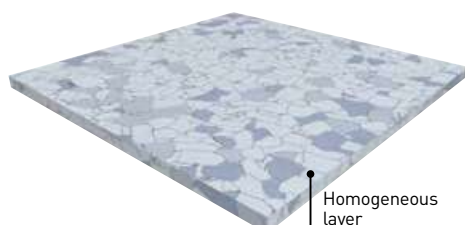

**MIPOLAM EL5** is a conductive flexible homogeneous vinyl floorcovering available in sheet. The 2 mm homogeneous material incorporates carbon encapsulated granules throughout its full thickness. It has a **conductive backing** to ensure optimal and consistent conductive properties throughout its full life expectancy. This floorcovering is treated with **Evercare™**: the latest improvements in polyurethane surface treatment obtained by UV laser cross-linking. Evercare™ avoids stain of chemical products used in healthcare like betadine, eosin or anti-bacterial hand gel and increases the durability of the flooring. According to ISO 21702, **MIPOLAM EL5** has **anti-viral activity** against Human Coronaviruses: it reduces the number of virus by 99.7% after 2h. According to ISO 22196, **MIPOLAM EL5** has **anti-bacterial activity** against E. coli, S. aureus and MRSA of 99% after 24h. This treatment has excellent maintenance characteristics; it requires no wax for life! **MIPOLAM EL5** acts as a continuous conductive  $10^4 \leq Rt \leq 10^6$ . The product has to be grounded with an ESD copper strip (see finishes) to meet its full performance. The product is non-reactive to residual indentation with a value  $\leq 0.02$  mm (EN ISO 24343-1) The flooring complies with the EN ISO 10874 (34-43) offering a binder content type II, is suitable for heavy duty traffic areas and has a Bfl-s1 fire resistance. The product is non-emissive of volatile organic compounds with  $<10$  microgram/m<sup>3</sup> (TVOC after 28 days ISO 16000-6).



**MIPOLAM TECHNIC EL5** is a conductive flexible homogeneous compacted vinyl floorcovering available in tiles. The conductive carbon coated PVC pellets create a perfect conductive network for permanent conductive and antistatic properties throughout its full life expectancy. It acts as a continuous conductive  $10^4 \leq Rt \leq 10^6$  (EN 1081).



# EL5 / EL7 SOLUTIONS



100% recyclable

**A complete range for Hi-tech applications: electronics and telecommunication areas, computer rooms, operating theatres, radiology...**

- ▶ **Compacted floorcovering for better hygiene, maintenance, and traffic resistance.**
- ▶ **Available in tiles and sheets with specific formats especially adapted to raised floors (608 x 608 mm).**

			MIPOLAM EL7	MIPOLAM ROBUST EL7	MIPOLAM EL5	MIPOLAM TECHNIC EL5
<b>DESCRIPTION</b>						
Total thickness	EN ISO 24346	mm	2	2	2	2
Weight	EN ISO 23997	g/sqm	3100	3300	2985	3800
Width of sheet	EN ISO 24341	cm	200	200	200	-
Length of sheet	EN ISO 24341	lm	20	20	20	-
Tile size	EN ISO 24342	mm	608 x 608	608 x 608	-	608 x 608
Number of tiles per package	-	-	20	20	-	20
<b>CLASSIFICATION</b>						
Norm / Product specification	-	-	EN ISO 10581	EN ISO 10581	EN ISO 10581	EN ISO 10581
European classification	EN ISO 10874	class	34-43	34-43	34-43	34-43
Fire rating	EN 13501-1	class	B <sub>fl</sub> -s1	B <sub>fl</sub> -s1	B <sub>fl</sub> -s1	B <sub>fl</sub> -s1
Electrical resistance <sup>(1)</sup>	EN 1081	Ohm	10 <sup>6</sup> ≤ Rt ≤ 10 <sup>8</sup>	10 <sup>6</sup> ≤ Rt ≤ 10 <sup>8</sup>	10 <sup>4</sup> ≤ Rt ≤ 10 <sup>6</sup>	10 <sup>4</sup> ≤ Rt ≤ 10 <sup>6</sup>
Static electrical propensity	EN 1815	kV	< 2	< 2	< 2	< 2
Slip resistance wet	DIN 51 130	class	R9	-	R9	-
<b>PERFORMANCES</b>						
Type Binder content	EN ISO 10581	type	II	II	I	II
Dimensional stability	EN ISO 23999	%	Sheet ≤ 0.40 Tile ≤ 0.25	Sheet ≤ 0.40 Tile ≤ 0.25	≤ 0.40	≈ 0.25
Residual indentation (norm)	EN ISO 24343-1		≤ 0.10	≤ 0.10	≤ 0.10	≤ 0.10
Residual indentation (average measured value)	EN ISO 24343-1	mm	≈ 0.02	≈ 0.03	≈ 0.02	≈ 0.03
Castor chair test (type W)	ISO 4918	-	OK	OK	OK	OK
Thermal conductivity	EN ISO 10456	W/(m.k)	0.25	0.25	0.25	0.25
Colour fastness	EN 20 105 - B02	degree	≥ 6	≥ 6	≥ 6	≥ 6
Surface treatment	-	-	Evercare™	-	Evercare™	-
Chemical products resistance <sup>(2)</sup>	EN ISO 26987	-	OK	OK	OK	OK
Anti-bacterial activity (E.coli - S. aureus - MRSA) after 24h <sup>(3)</sup>	ISO 22196	-	> 99% inhibits growth	-	> 99% inhibits growth	-
Anti-viral activity (human coronavirus) after 2h <sup>(3)</sup>	ISO 21702	-	> 99.7% virucidal activity	-	> 99.7% virucidal activity	-
<b>ENVIRONMENT / INDOOR AIR QUALITY</b>						
TVOC after 28 days	ISO 16000-6	microgram/m <sup>3</sup>	< 10	< 10	< 10	< 10
Certification	-	-	Floorscore®	-	Floorscore®	-
<b>CE MARKING</b>						
CE	EN 14041					

(1) Measured before installation.

(2) Staining table available upon request.

(3) The implementation of an effective cleaning method is the best defence against infection

**Important:** please refer to Gerflor installation guidelines - [www.gerflor.com](http://www.gerflor.com)

# TECHNICAL SOLUTIONS

## EL7 SOLUTIONS: MIPOLAM EL7 & ROBUST EL7

### MIPOLAM EL7



 $10^6 \leq Rt \leq 10^8 \Omega$ 

 100% recyclable



4120 Silver Grey



^ Scale 1



4166 Thistle



4159 Grey Storm



4101 Quartz



4120 Silver Grey



4116 Sapphire



4111 Raffia

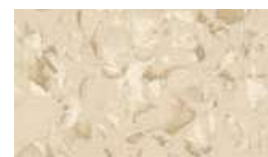

4124 Smoked Opal



4110 Violet Grey



4144 Havana Brown



4132 Citrine



### MIPOLAM ROBUST EL7



 $10^6 \leq Rt \leq 10^8 \Omega$ 
 100% recyclable



0003 Ivory



^ Scale 1



0005 Steel



0013 Pewter



0003 Ivory



0112 Storm



0306 Green



0002 Platinum



# EL5 SOLUTIONS: MIPOLAM EL5 / TECHNIC EL5 / GTI EL5

## MIPOLAM EL5



$10^4 \leq Rt \leq 10^6 \Omega$

Evercare™

100% recyclable

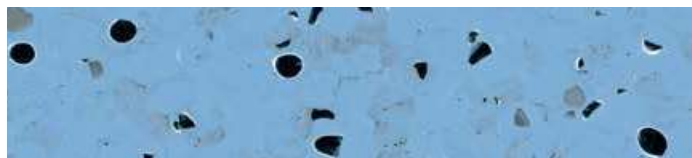

0354 Blue



^ Scale 1



0350 Light Grey



0353 Beige



0354 Blue



0352 Grey



0351 Black

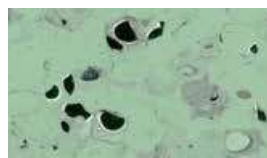

0355 Green



## MIPOLAM TECHNIC EL5



$10^4 \leq Rt \leq 10^6 \Omega$

100% recyclable



0637 Light Blue



^ Scale 1



0635 White



0636 Grey



0637 Light Blue



0640 Beige



0638 Blue



0639 Green



## GTI EL5

More information on GTI EL5 tile, refer to pages 184-187



Removable

R9

Evercare™

100% recyclable



# TECHNICAL SOLUTIONS

## SAFETY FLOORINGS - TARASAFE

### TARASAFE GEO: SPARCLEAN® TREATED

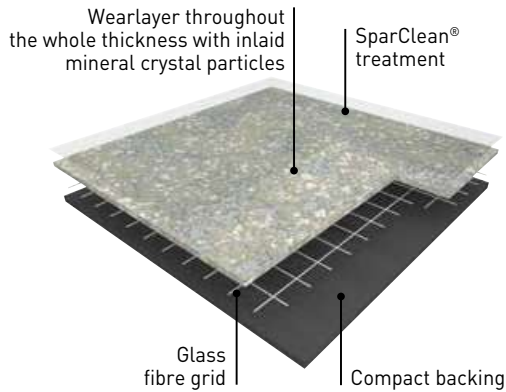

**TARASAFE GEO** is a slip resistant vinyl floorcovering, with a PVC wear layer and deeply inlaid mineral crystal particles (patented) and coloured chips for a decorative design. It is reinforced with a glass fibre grid in sheet form.

It is an ideal solution for heavy traffic applications where slip resistance, durability, hygiene and easy maintenance are required. **TARASAFE GEO** is suitable for most contract & commercial areas. It is eco-friendly, 100% recyclable, Floorscore® certified and does not contain any heavy metals or CMR 1&2, it is also 100% compliant with REACH.

The product emission rate of volatile organic compounds is < 100 microgram/m<sup>3</sup> (TVOC after 28 days – ISO 16000 -6).

The **SparClean®** surface treatment improves the product performance in terms of stain and dirt resistance and designs last longer for extended durability.

According to ISO 22196, **TARASAFE GEO** has **anti-bacterial activity** against MRSA of 99% after 24h.

### TARASAFE ULTRA / ULTRA COMFORT: SPARCLEAN® TREATED

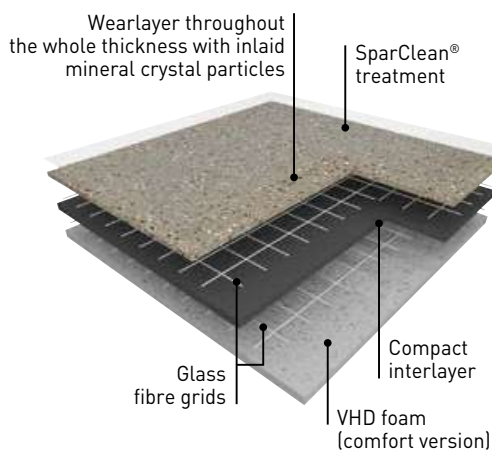

**TARASAFE ULTRA & ULTRA COMFORT** are slip resistant safety vinyl floorcoverings, with a PVC wear layer and deeply inlaid mineral crystal particles (patented) and coloured chips for a decorative design. They are reinforced with a glass fibre grid and are available in a sheet format.

The ranges are ideal for heavy traffic applications where slip resistance, durability, hygiene and easy maintenance are required. Suitable for most contract & commercial areas, they are a popular choice in the education and healthcare environments, the matt finish surface is also perfectly suitable for dementia care units.

They are eco-friendly, 100% recyclable, Floorscore® certified and do not contain any heavy metals or CMR 1&2. They are also 100% compliant with REACH.

The product emission rate of volatile organic compounds is < 100 microgram/m<sup>3</sup> (TVOC after 28 days – ISO 16000 -6).

The **SparClean®** surface treatment improves the product performance in terms of stain and dirt resistance and designs last longer for extended durability.

According to ISO 22196, **TARASAFE ULTRA** has **anti-bacterial activity** against MRSA of 99% after 24h.

**TARASAFE ULTRA COMFORT** has a VHD closed cell foam backing yielding a 16 dB sound insulation.

### TARASAFE ULTRA H2O

See page 209

# TARASAFE

## ▶ TARASAFE STANDARD: PUR TREATED .....

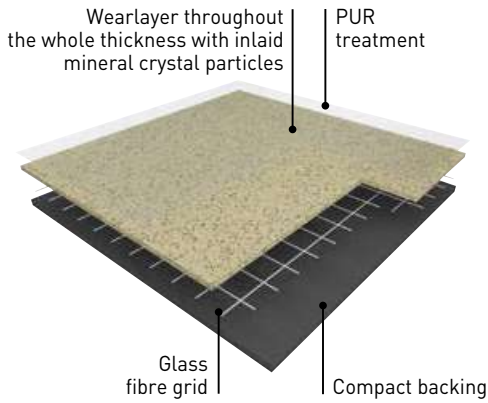

**TARASAFE STANDARD** with **PUR** surface treatment is a slip resistant safety vinyl floorcovering, with a PVC wear layer and deeply inlaid mineral crystal particles (patented). It is reinforced by a glass fibre grid and available in a sheet format. It is an ideal solution for heavy traffic applications where slip resistance, durability, hygiene and easy maintenance are required.

**TARASAFE STANDARD** is suitable for most contract & commercial areas. It is eco-friendly, 100% recyclable, Floorscore® certified and does not contain any heavy metals or CMR 1&2, it is also 100% compliant with REACH.

The product emission rate of volatile organic compounds is < 100 microgram/m<sup>3</sup> (TVOC after 28 days – ISO 16000 -6).

The **PUR** surface treatment improves the product performance in term of stain resistance and durability.

According to ISO 22196, **TARASAFE STANDARD** has **anti-bacterial activity** against MRSA of 99% after 24h.

## ▶ TARASAFE PLUS / TARASAFE SUPER: NON-TREATED .....

### TARASAFE SUPER

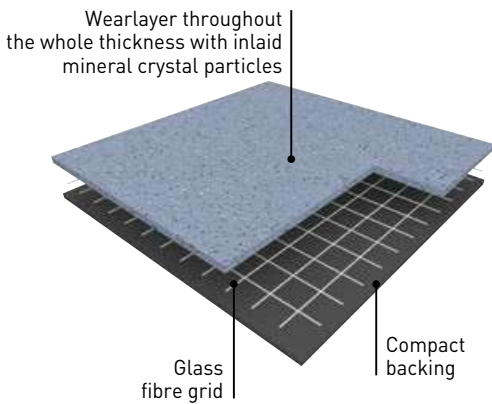

**TARASAFE PLUS** and **TARASAFE SUPER** are slip resistant safety vinyl floorcoverings, with a PVC wear layer and deeply inlaid mineral crystal particles (patented). They are reinforced by a glass fibre grid and available in a sheet format. They are an ideal solution for heavy traffic applications where slip resistance, durability, hygiene and easy maintenance are required.

**TARASAFE PLUS** comprises a textile backing for better adherence in wet areas. It helps reducing telegraphing.

**TARASAFE SUPER** and **PLUS** are suitable for most contract & commercial areas. They are eco-friendly, 100% recyclable, Floorscore® certified and do not contain any heavy metals or CMR 1&2, they are also 100% compliant with REACH.

The product emission rate of volatile organic compounds is < 100 microgram/m<sup>3</sup> (TVOC after 28 days – ISO 16000 -6).

### TARASAFE PLUS

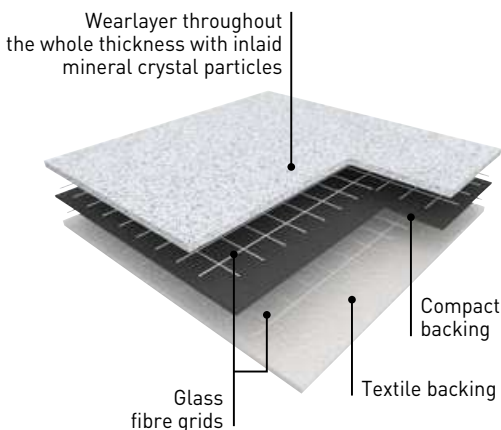

# TECHNICAL SOLUTIONS

## TARASAFE



- ▶ **Easy to clean and maintain:** due to a compacted non porous surface made of vinyl content
- ▶ **Permanent slip resistance:** dense concentration of deep inlaid mineral crystal particles throughout the wear layer
- ▶ **Enhanced colour, design and brightness:** due to the mineral crystal particles
- ▶ **Highest abrasion rating**
- ▶ **Indoor Air Quality:** low VOC emission

			TARASAFE					
			GEO	ULTRA	STANDARD	ULTRA COMFORT	SUPER	PLUS
<b>DESCRIPTION</b>								
Total thickness	EN ISO 24346	mm	2.0	2.0	3.2	2.2	2.5	
Thickness of wearlayer	EN ISO 24340	mm	1.00	0.85	0.85	0.85	1.12	1.14
Weight	EN ISO 23997	g/sqm	2370	2460	2460	2960	2880	3090
Width/Length of sheet	EN ISO 24341	cm/ml	200/20	200/20	200/20	200/20	200/20	200/20
<b>CLASSIFICATION</b>								
Norm/Product specification	-	-	EN ISO 10582		EN 651	EN ISO 10582		
European classification	EN ISO 10874	class	34-43	34-43	34-42	34-43		
Fire rating	EN 13501-1	class	B <sub>fl</sub> -s1	B <sub>fl</sub> -s1	B <sub>fl</sub> -s1	B <sub>fl</sub> -s1		
Static electrical propensity	EN 1815	kV	< 2	< 2	< 2	< 2		
<b>SLIP RESISTANCE</b>								
Pendulum Test (dry & wet)	BS 7976-2	PTV (degree)	> 36	> 36	-	-		
Surface roughness	-	µm	Rz ≥ 20	Rz ≥ 20	-	-		
Ramp test with oil	DIN 51 130	class	R10	R10	R10	R12	R10	
Ramp test with water	DIN 51 097	class	B	B	-	-		
Ramp test	EN 13845 (annex C)	class	ESf / ESb	ESf / ESb	-	-		
<b>PERFORMANCES</b>								
Wear resistance	EN 660.2	mm <sup>3</sup>	≤2	≤2	≤2	≤2		
Wear group	-	-	T	T	T	T		
Type Binder content	EN ISO 10582	type	I	I	-	I		
Dimensional stability	EN ISO 23999	%	≤ 0.40	≤ 0.40	≤ 0.40	≤ 0.40		
Residual indentation: exigency	EN ISO 24343-1	mm	≤ 0.10	≤ 0.10	≤ 0.20	≤ 0.10		
Residual indentation (average measure)	-	mm	≈ 0.03	≈ 0.05	≈ 0.03	≈ 0.03		
Castor chair test (type W)	ISO 4918	-	OK	OK	OK	OK		
Impact sound Insulation	EN ISO 717-2	dB	-	-	16	-		
Thermal conductivity	EN ISO 10456	W/(m.K)	0.25	0.25	0.25	0.25		
Colour fastness	EN 20 105-B02	degree	≥ 6	≥ 6	≥ 6	≥ 6		
Surface treatment	-	-	SparClean®	PUR	SparClean®	-		
Chemical products resistance	EN ISO 26987	-	OK	OK	OK	OK		
Anti-bacterial activity (MRSA) <sup>(1)</sup>	ISO 22196	-	> 99% inhibits growth	> 99% inhibits growth	> 99% inhibits growth	-		
<b>ENVIRONMENT / INDOOR AIR QUALITY</b>								
TVOC after 28 days	ISO 16000-6	microgram/m <sup>3</sup>	< 100	< 100	< 100	< 100		
Certification	-	-	Floorscore®	Floorscore®	Floorscore®	Floorscore®		
<b>CE MARKING</b>								
CE	EN 14041							

(1) The implementation of an effective cleaning regime is the most important defence against infection.



# TARASAFE GEO



2 m

R 10

SparClean®



3409 Ocean Wave

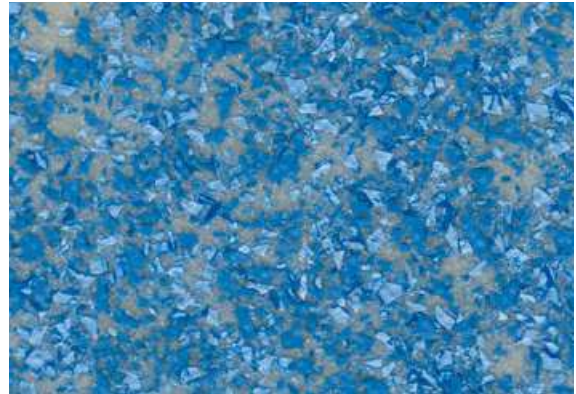

3409 Ocean Wave

^ Scale 1



3775 Crystalline



3772 Cliff



3771 Rock



8081 Trail

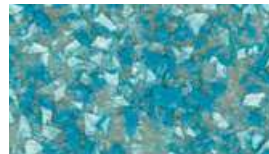

3405 Turquoise



3303 Desert



3105 Sunspot

Technical  
Solutions

# TECHNICAL SOLUTIONS

## TARASAFE ULTRA, TARASAFE ULTRA COMFORT

 2 m | 
  2 m | 
 R 10 | 
 SparClean® | 
  Blade Save  
 3 times more blade life | 
  100% recyclable  
 contains recycled materials



8709 Granite

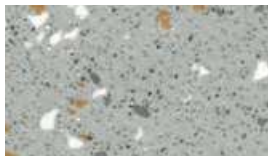

8704 Pebble

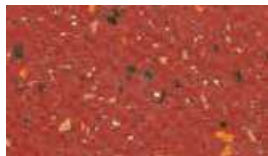

4128 Ruby

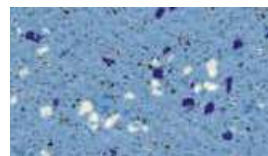

7482 Halite

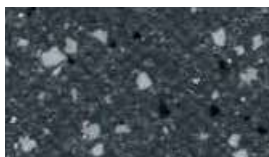

8717 Obsidian



8710 Basalt



8013 Jasper

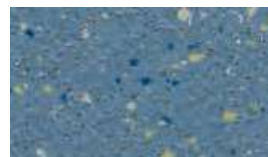

4465 Cobalt

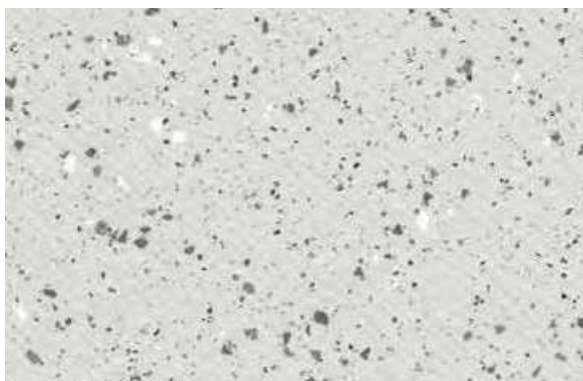

8701 Opal



^ Scale 1

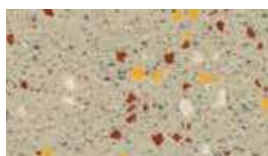

7384 Citrine



4472 Moonstone

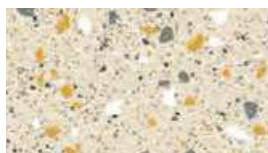

7383 Diopside

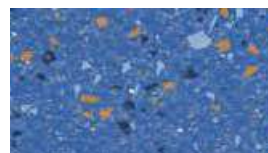

4470 Sapphire



8701 Opal



4323 Sandstone

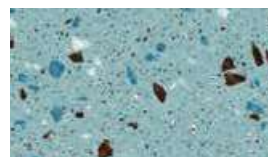

4463 Aqua

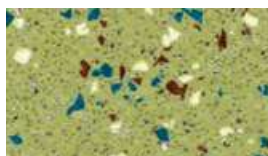

4505 Peridot

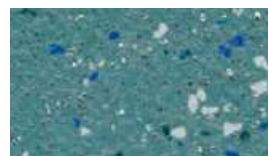

4460 Topaz

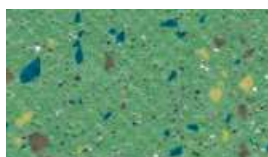

4508 Jade



 Color reference available as Tarasafe Ultra H2O (R11).



# TARASAFE STANDARD - PLUS - SUPER

## TARASAFE STANDARD

Compact 2 m | R 10 | PUR

## TARASAFE PLUS

Plus 2.5mm Compact Textile backing 2 m | R 10

## TARASAFE SUPER

Compact 2 m | R 12



7302 Sahara<sup>(1)</sup>



^ Scale 1



7618 Edelweiss



7731 Marbre<sup>(1)</sup>



7386 Savana<sup>(1) (2)</sup>



7767 Dove Grey<sup>(1) (2)</sup>



7312 Dune

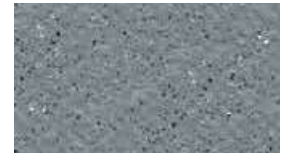

7773 Storm



7115 Flame



7508 Avocado



7107 Poppy



7704 Sky Blue



7801 Noir



7438 Baleine<sup>(1) (2)</sup>



7709 Royal Blue



7801 Noir

(1) Tarasafe Plus - (2) Tarasafe Super

Technical Solutions



# TECHNICAL SOLUTIONS

## SHOWER SYSTEM

### ELEGANCE SD

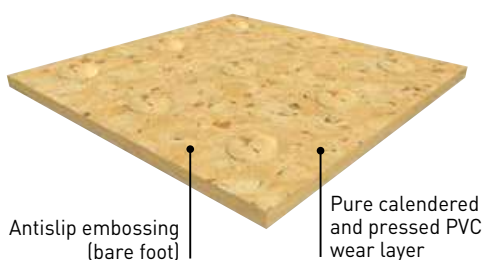

**SHOWER SYSTEM ELEGANCE SD** is a flexible homogeneous calendered compacted floorcovering available in 2 m sheet, with a non-directional polychrome design, to offer an even colour throughout the thickness. It should be hot welded with a CR 40 welding rod.

**SHOWER SYSTEM ELEGANCE SD** is specifically embossed for wet barefoot traffic. **ELEGANCE SD** is compliant with antislip resistance norms (R9 according to DIN 51130 and B classification according to DIN 51097) for a **safe usage** in barefoot or shod applications such as showers. The Shower System enables access for all in showers especially for disabled people. It is made of 32% mineral material and 34% renewable material. It uses 100% controlled recycled material. The TVOC emissions in the air at 28 days (EN 16000) are < 10 microgram/m<sup>3</sup>. It is 100% recyclable.

### TARASAFE ULTRA H2O

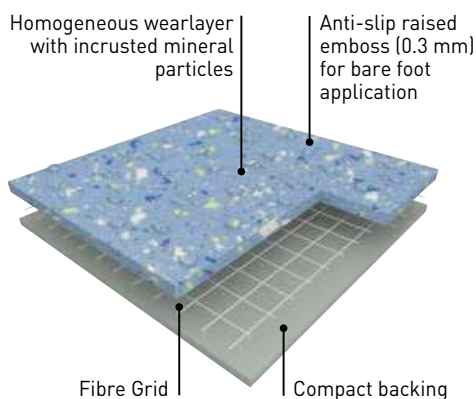

**TARASAFE ULTRA H2O** is a slip resistant vinyl floorcovering, with a PVC wear layer and deeply inlaid mineral particles and coloured chips for a decorative design together with a raised emboss for better slip resistance.

**TARASAFE ULTRA H2O** is an ideal solution for traffic applications where enhanced slip resistance with barefoot and durability are required such as wet areas. The specific embossing together with the mineral particles give a Class C barefoot slip resistance (DIN 51 097) and R11 slip resistance (DIN 51 130) which makes **TARASAFE ULTRA H2O** ideal for barefoot or shod applications.

It is reinforced with a glass fibre grid in sheet form. Its homogeneous wear layer provides a group P of abrasion.

According to ISO 22196, **TARASAFE ULTRA H2O** has **anti-bacterial activity** against MRSA of 99% after 24h.

It does not contain any heavy metals or CMR 1&2 and it is 100% compliant with REACH. The product emission rate of volatile organic compounds is < 100 microgram/m<sup>3</sup> (TVOC after 28 days – ISO 16000 -6). This product is 100% recyclable and contents 18% of mineral material and 22% of inexhaustible material.

### MURAL CALYPSO

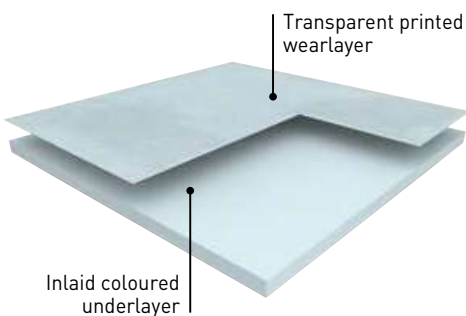

**MURAL CALYPSO** is a multilayered wall covering in 2 m width roll and with a **B-s2,d0 fire classification** according to EN 13501.

It is hot welded with CR41 welding rods for a perfect water tightness. It is made of a printed transparent wear layer and a coloured under layer for a better aspect of the welding. This layer comprises 20% of recycled products.

According to ISO 22196, **MURAL CALYPSO** has **anti-bacterial activity** against E. coli, S. aureus and MRSA of 99% after 24h.

It does not contain any CMR 1 & 2 component and is 100% compliant with REACH.

It is 100% recyclable.

This wall covering is specially recommended for wet room areas and makes the installation in angles easier thanks to its flexibility.

The Shower System is compliant with most laws on "access for all" thanks to the installation in shower without tray.

Gerflor also recommends the Tarasafe compact ranges with surface treatments (SparClean®: Geo & Ultra / PUR: Standard) for the use in wet room areas.





See pages 203-205

# ELEGANCE SD / TARASAFE ULTRA H2O / MURAL CALYPSO



The **SHOWER SYSTEM** provides a safe and hygienic solution thanks to:

- ▶ **Anti-slip resistance floorings**
- ▶ **100% waterproof installation**

			ELEGANCE SD	TARASAFE ULTRA H2O	MURAL CALYPSO
<b>DESCRIPTION</b>					
Total thickness	EN ISO 24346	mm	2.4 (on grainside)	2.0 (on grainside)	0.92
Thickness of wearlayer	EN ISO 24340	mm	2.40	1.0	0.10
Weight	EN ISO 23997	g/sqm	3100	2400	1610
Width/Length of sheet	EN ISO 24341	cm/ml	200/20	200/20	200/30
<b>CLASSIFICATION</b>					
Product specification	-	-	EN ISO 10581	EN ISO 10582	EN 15 102
European classification	EN ISO 10874	class	34-43	34-43	-
Fire rating	EN 13501-1	class	Bfl-s1	Cfl-s1	B-s2,d0
Static electrical propensity	EN 1815	kV	< 2	< 2	-
Slip resistance wet: ramp test with oil	DIN 51130	class	R9	R11	-
Slip resistance wet: bare foot	DIN 51 097	class	B	C	-
Determination of slip resistance barefoot & shod + water	EN 13845-annexe C	class	-	ESb	-
Water tightness	EN 13553	-	OK	In progress	-
Slip resistance wet areas	CTE	class	-	3	-
<b>PERFORMANCES</b>					
Wear resistance	EN 660.2	mm <sup>3</sup>	≤ 4.0	≤ 4.0	-
Wear group	NF 189	group	P	P	-
Type Binder content	ISO 10581	type	I	-	-
Type Binder content	ISO 10582	type	-	I	-
Dimensional stability	EN ISO 23999	%	≤ 0.40	≤ 0.40	-
Residual indentation	EN ISO 24343-1	mm	≤ 0.10	≤ 0.10	-
Residual indentation (measure)	-	mm	≈ 0.03	≈ 0.03	-
Thermal conductivity	EN ISO 10456	W/(m.k)	0.25	0.25	-
Colour fastness	EN 20 105 - B02	degree	≥ 6	≥ 6	≥ 6
Chemical products resistance	EN ISO 26987	-	OK	OK	OK
Anti-bacterial activity <sup>(1)</sup> (E. coli - S. aureus - MRSA)	ISO 22196	-	-	> 99% <sup>(2)</sup> inhibits growth	> 99% <sup>(3)</sup> inhibits growth
<b>ENVIRONMENT / INDOOR AIR QUALITY</b>					
TVOC after 28 days	ISO 16000-6	microgram/m <sup>3</sup>	< 10	< 100	-
Certification	-	-	Floorscore®	Floorscore®	-
<b>CE MARKING</b>					
<b>CE</b>	EN 15102		-		OK
	EN 14041				
					-

(1) The implementation of an effective cleaning regime is the most important defence against infection.

(2) Anti-bacterial activity (MRSA)

(3) Anti-bacterial activity (E. coli - S. aureus - MRSA)

# TECHNICAL SOLUTIONS

## ANTISLIP FLOORINGS - ELEGANCE SD



Compact



100% recyclable



0700 Melon



0700 Melon

^ Scale 1



0329 Hazelnut



0704 Raspberry Grey



0322 Jicama

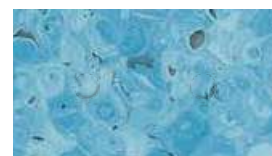

0341 Bilberry



0705 Patisson





# ANTISLIP FLOORINGS - TARASAFE ULTRA H2O



100% recyclable



7720 Iceberg

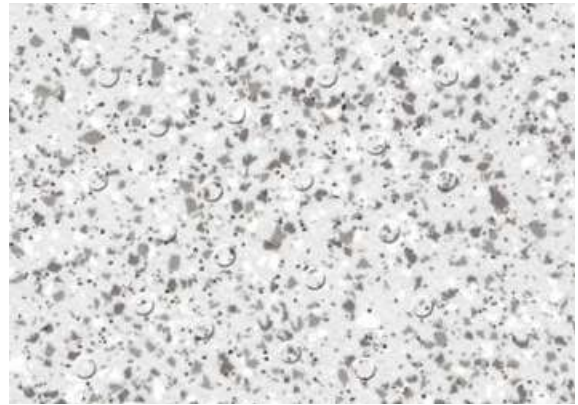

7720 Iceberg

^ Scale 1



7732 Gravel

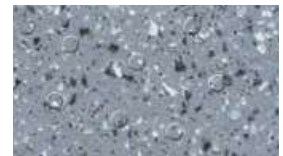

7746 Stone



7325 Seashore

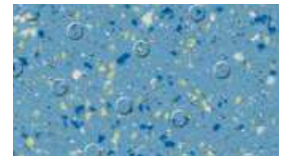

7418 Marine

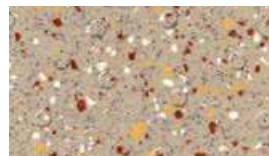

7314 Sand

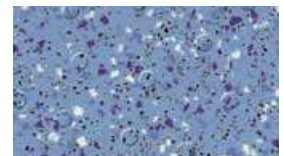

7413 Ocean Blue

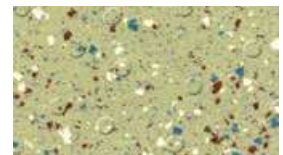

7513 Seagrass

# TECHNICAL SOLUTIONS

## MURAL CALYPSO

 Compact | **Bs2d0** |  100% recyclable

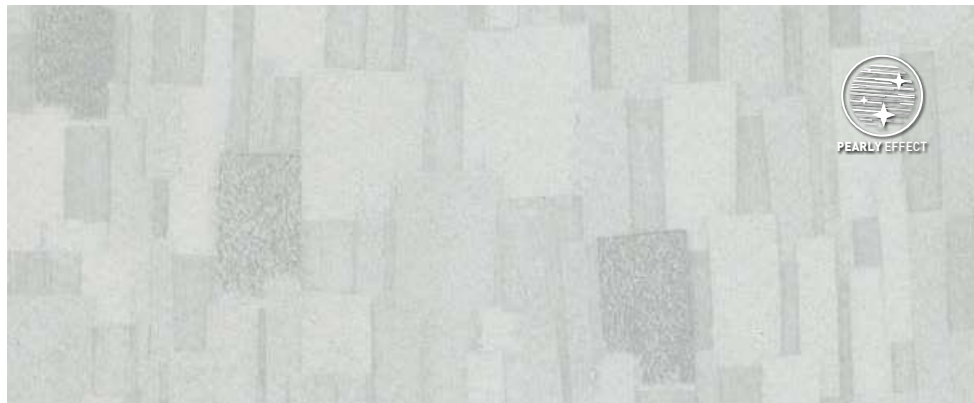

7004 Prism Haze Pearl



^ Scale 1



7003 Prism Ice



7734 Manhattan Concrete



7728 Manhattan Stone

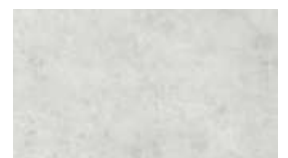

7721 Manhattan Mist



7009 Fossil Haze



7008 Fossil Ice



7004 Prism Haze Pearl



7002 Bamboo Lotus



7744 Nordic Milk

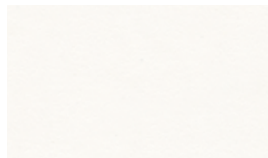

7611 Snow

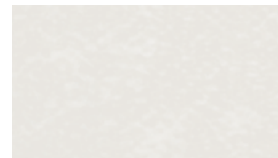

7711 Ice



7000 Bamboo Snow Pearl



7753 Nordic Zen



7104 Melon



7715 Crystal



7001 Bamboo Haze Pearl



7005 Blossom Snow Pearl

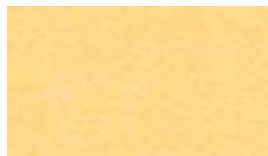

7201 Moonlight



7714 Frost



7740 Fabric Silk



7006 Blossom Haze Pearl

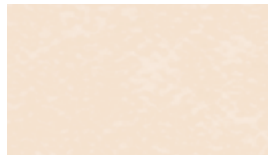

7309 Lotus



7408 Skyline



7736 Fabric Wool



7007 Blossom Lichen



7311 Linen



7012 Breeze



7414 Fabric Denim



7011 Lichen



7712 Shadow



7010 Haze





# TECHNICAL SOLUTIONS

## WALLCOVERINGS

### MURAL ULTRA / MURAL CLUB / MURAL CALYPSO

#### ▶ MURAL ULTRA

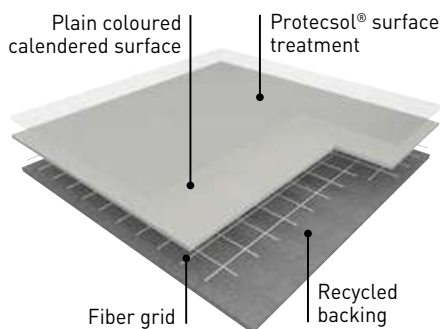

**MURAL ULTRA** is a flexible wall covering vinyl sheet which has a thickness of 1.5 mm for an extended durability. It has a B-s2,d0 fire classification (EN 13501-1) which complies with most European fire regulations. It is made of a pure PVC coloured surface and a backing which comprises 25% of recycled products. This multi-layered product is reinforced with a non-woven glassfibre grid for improved resistance to tearing and excellent dimensional stability. It has a great resistance to chemical products staining thanks to its **Protecsol®** surface treatment.

According to ISO 22196, **MURAL ULTRA** has **anti-bacterial activity** against E. coli, S. aureus and MRSA of 99% after 24h.

The joints are hot-welded to ensure perfect water-tightness. It is 100% recyclable and the components are 100% compliant with REACH.

#### ▶ MURAL CLUB

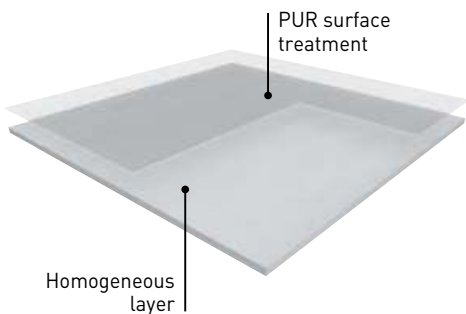

**MURAL CLUB** is a homogeneous wall covering in 2 m width roll and with a B-s2,d0 fire classification. It is designed to be a permanent wall covering. It is hot welded with CR40 welding rods for better hygiene.

It is made of calendered layer with colour throughout the whole thickness for a nicer aspect of the welding. This layer comprises at least 10% of recycled products. It does not contain any CMR 1 & 2 component and is 100% compliant with REACH. It is 100% recyclable.

**MURAL CLUB** benefits from a **PUR** surface treatment which provides good resistance to chemical products and makes maintenance easier.

According to ISO 22196, **MURAL CLUB** has **anti-bacterial activity** against E. coli, S. aureus and MRSA of 99% after 24h.

Full resistant to impact, it acts as a buffer against damage from beds, trolleys and indoor motorized vehicles and other transportation systems.

**MURAL CLUB** is fully impact resistant and is therefore ideal for use as a cladding in large public buildings such as hospitals care institutions dental and veterinary surgeries, clean rooms, stores and supermarkets, warehouse and storage areas.

#### ▶ MURAL CALYPSO

See page 210

# WALLCOVERINGS

## MURAL ULTRA / MURAL CLUB

- ▶ Easily seam welded to produce continuous surfaces.
- ▶ Create a safe and hygienic environment.
- ▶ Flexible and easy to cove.
- ▶ Ideal for walls and ceilings.
- ▶ Recyclable and Eco responsible.

			MURAL ULTRA	MURAL CLUB
<b>DESCRIPTION</b>				
Total thickness	EN ISO 24346	mm	1.5	1.00
Thickness of wearlayer	EN ISO 24340	mm	0.65	1.00
Weight	EN ISO 23997	g/sqm	2600	1780
Width/Length of sheet	EN ISO 24341	cm/ml	200 / 21	200 / 30
<b>CLASSIFICATION</b>				
Product specification	-	-	EN 15 102	EN 15 102
Fire rating	EN 13501-1	class	B-s2,d0	B-s2,d0
<b>PERFORMANCES</b>				
Colour fastness	EN 20 105 - B02	degree	≥ 6	≥ 6
Surface treatment	-	-	Protecsol®	PUR
Chemical products resistance	EN ISO 26987	-	OK	OK
Anti-bacterial activity (E. coli - S. aureus - MRSA) <sup>(1)</sup>	ISO 22196	-	> 99% inhibits growth	> 99% inhibits growth
<b>CE MARKING</b>				
	EN 15102		OK	

*(1) The implementation of an effective cleaning regime is the most important defence against infection.*



# TECHNICAL SOLUTIONS

## MURAL ULTRA



Protocolsol®



100% recyclable



4116 Apricot



^ Scale 1

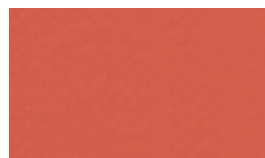

4150 Cranberry\*

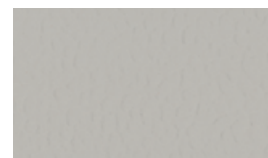

3765 Flannel

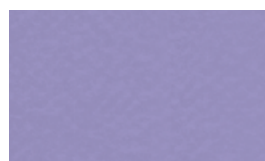

4118 Violet\*

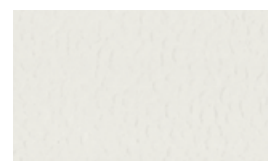

3735 Arctic

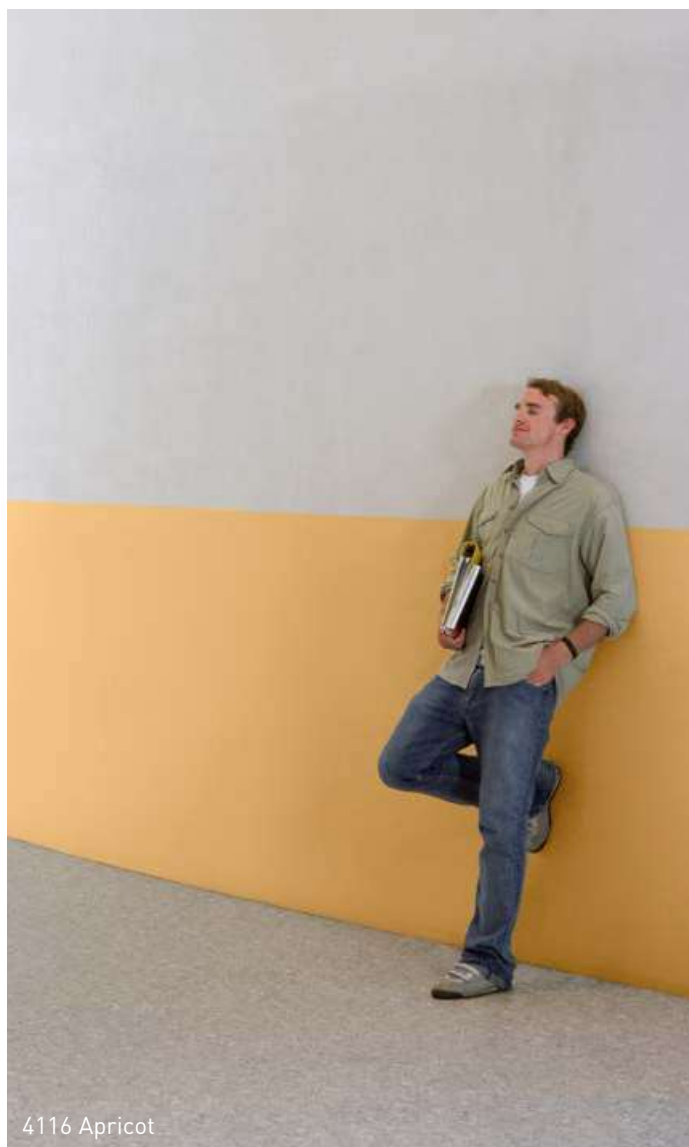

4116 Apricot

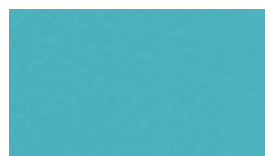

4494 Pacific

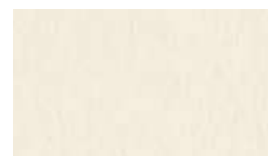

8608 Lily



4497 Lobelia

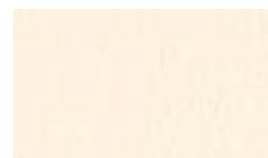

4345 Ecrú



4525 Lime



4346 Sand



8253 Lemon



\*Available for a minimum order quantity of 2000 sqm.



# MURAL CLUB



PUR



100% recyclable



0001 White

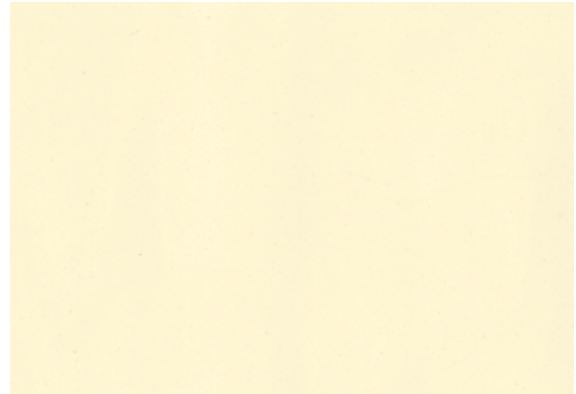

0005 Yellow

^ Scale 1



0006 Grey

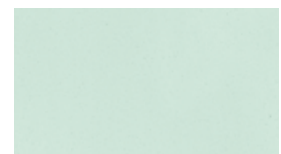

0004 Green

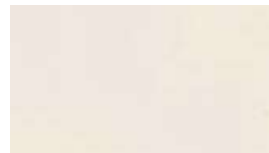

0003 Sand



0007 Blue

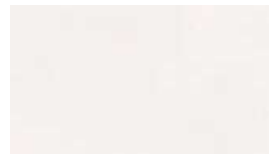

0001 White





The background of the entire page is a complex, multi-colored marbled pattern. It features swirling, organic shapes in shades of yellow, orange, brown, blue, and green, creating a rich, textured appearance. The colors are layered and blended, giving it a sense of depth and movement.

DLW  
LINOLEUM

PAGES

**216/245**



# Creative by Nature

## KEY POINTS TO REMEMBER ABOUT GERFLOR DLW LINOLEUM

- 1** The DLW brand stands for **150 years of experience** and has been considered a **reference since its creation**.
- 2** The greenest solution on the market:  
**98% bio based material / 76% rapidly renewable / up to 40% recycled content.**
- 3** **Unlimited possibilities** in terms of **creativity**, allowing unique and **differentiating designs**.
- 4** Adapted to numerous types of buildings, from **education to healthcare**, from **public buildings to offices**, thanks to a complete portfolio of **compact, acoustic, sport and industrial solutions**.

### Compact Linoleum..... 226-237

- Marmorette 228-230
- Arabesque 231
- Colorette 232
- Uni Walton 233
- Lino Art 234-237
  - Urban 234
  - Star 235
  - Metallic 236
  - Flow 237

### Acoustic Linoleum..... 238-241

- Marmorette Acoustic 240
- Marmorette AcousticPlus 240
- Colorette AcousticPlus 241

### Technic Linoleum..... 242-243

- High Mechanical Traffic Linodur 243
- Dissipative Linoleum Marmorette LCH 243

### Finishes ..... 244

### Cleaning Linoleum Floors ..... 245



# DLW LINOLEUM - Sustainable by Nature

## Natural Composition

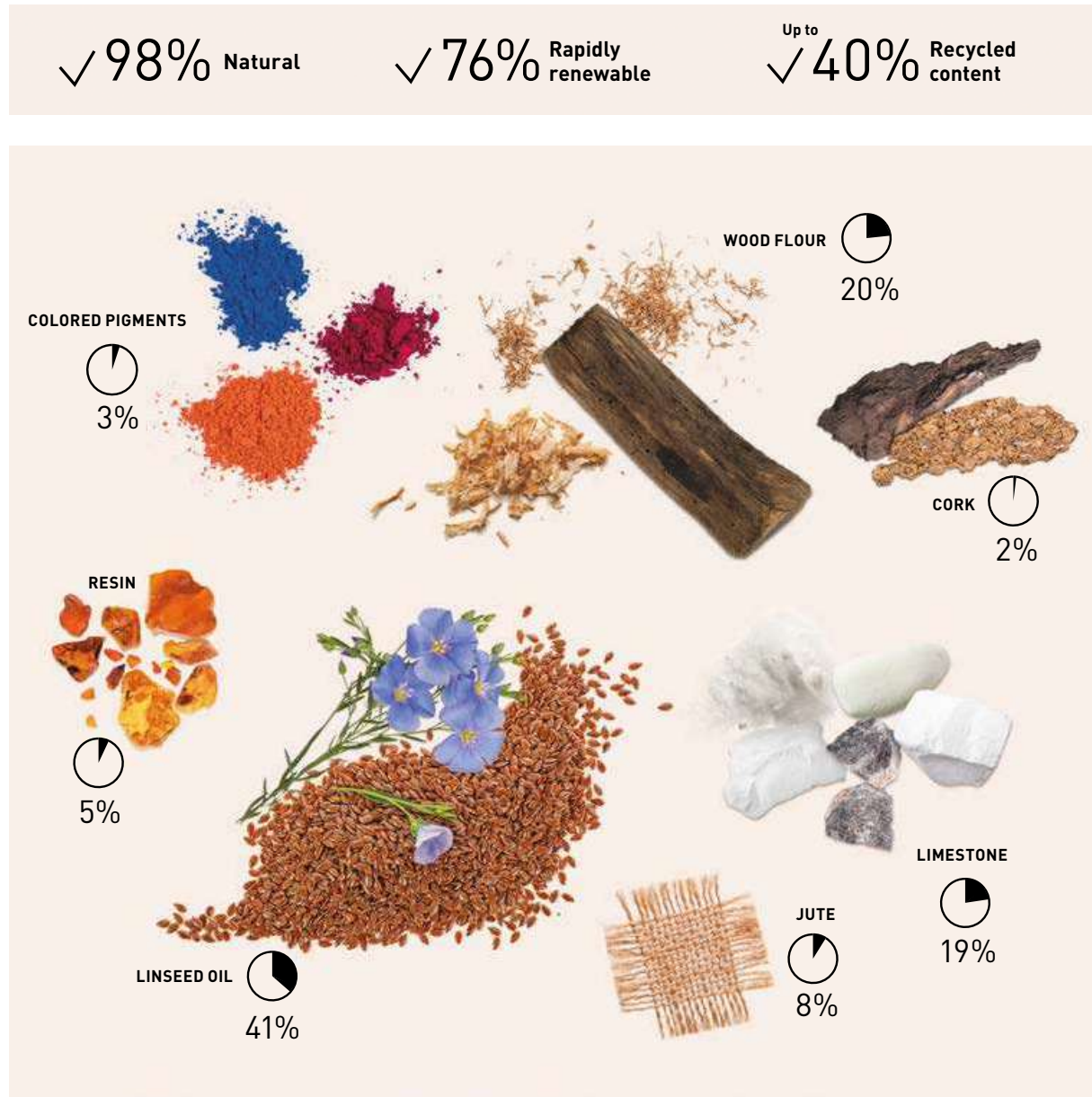

## Eco labels

### QUALITY



### LIFE CYCLE ANALYSIS



### INDOOR AIR QUALITY



## Cradle to Cradle Certified™ Silver<sup>(1)</sup>

Developed using circular economy principles

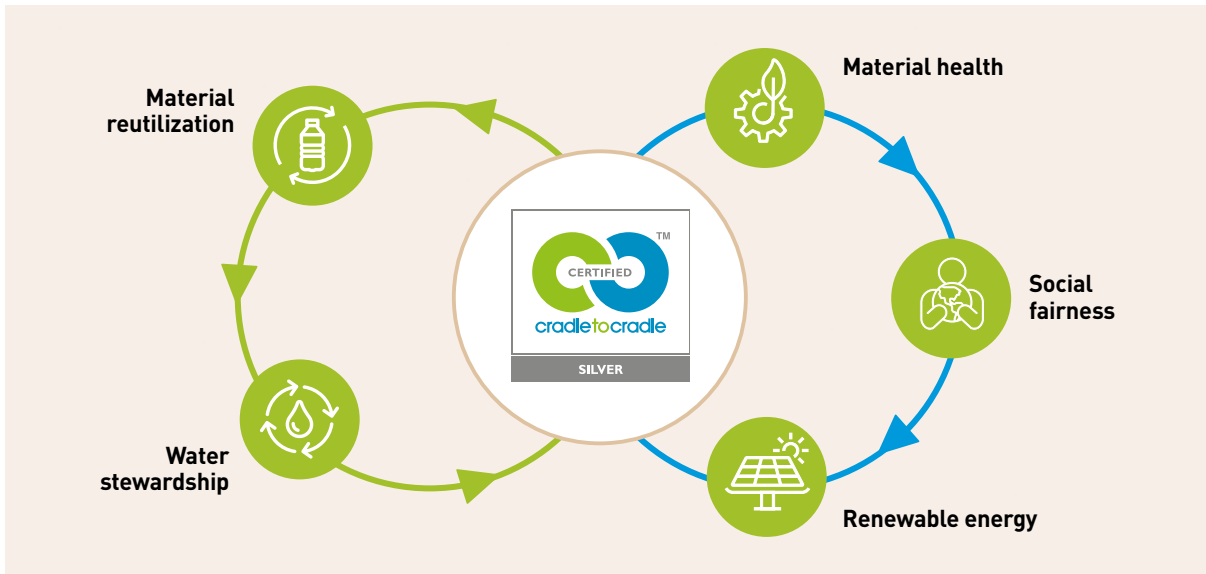

[1] Marmorette, Arabesque, Colorette, Uni Walton, Lino Art  
Cradle Certified™ is a registered trademark of the Cradle to Cradle Products Innovation Institute.

## Carbon neutral<sup>(2)</sup>

Third party certified EPD indicates carbon neutrality during the first stages of its life cycle.



[2] From Cradle to Gate: includes raw materials and manufacturing process (A1-A3 stages of EPD)  
Source: Environmental Performance Declaration (EPD). Certified by Enea. More information on [gerflor.com](http://gerflor.com)

# DLW LINOLEUM - Protective by Nature



NEW SOLVENT-FREE SURFACE PROTECTION,  
DEVELOPED EXCLUSIVELY FOR LINOLEUM.  
Extremely hard-wearing due to triple laser UV cross-linking technology



## INDOOR AIR QUALITY



- Very low VOC emissions  
TVOC < 10 microgram/m<sup>3</sup>  
after 28 days (ISO 16516)



- Certified according to the most demanding standards



[www.blauerengel.de/uz120](http://www.blauerengel.de/uz120)



CERTIFIED BY  
SCS Global Services



## NATURAL DESIGN

MATT EFFECT



LPX / PUR / OTHERS...







## EASY TO CLEAN



Standard Linoleum



NEOCARE™

- Dirt and stain barrier
- Cost effective maintenance
- Easy cleaning with a mop or any modern cleaning equipment

*Detailed cleaning protocol available on [www.gerfor.com](http://www.gerfor.com)*



## HYGIENE

DLW Linoleum floorings contribute to lower the microbe load (bacteria, virus, ...) and to minimise the risk of a contamination chain.

- Excellent resistance against disinfection chemicals
- Anti-viral and anti-bacterial activity



## DURABLE



- No sealing and waxing needed
- Higher scratch resistance
- Easy to repair: in case of heavily damaged flooring, DLW linoleum can be easily repaired using the spray buffing method (red disk)

## WAXING

NEOCARE™ is a high performing surface treatment protecting against dirt, stains and scratches and does not require any sealing & waxing throughout the life of the product. Waxing remains an option.



Black disk





Uni Walton  
0100 Ocean Blue

Lino Art Flow  
0030 Rain



# DLW LINOLEUM

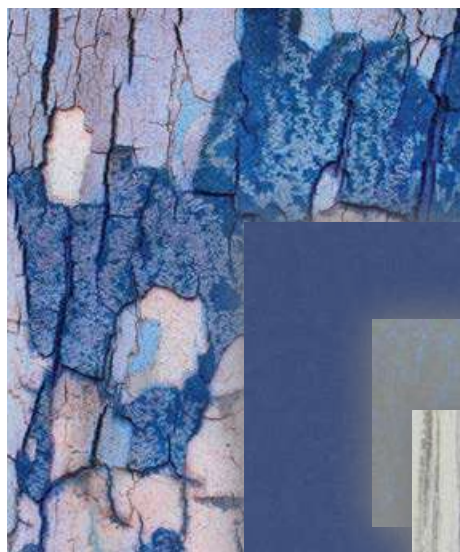

Lino Art Urban  
0566 Shining Blue



Uni Walton  
0100 Ocean Blue



Lino Art Flow  
0030 Rain

*Mix and match*

**Visualize your project**

[interiordesigner.gerflor.com](http://interiordesigner.gerflor.com)



Lino Art Urban  
0555 Flashy Street Grey



Lino Art Flow  
0024 Magma



Marmorette  
0117 Mandarin Orange





# DLW LINOLEUM

			MARMORETTE	ARABESQUE	COLORETTE
<b>DESCRIPTION</b>					
Total thickness	EN ISO 24346	mm	2.0 / 2.5 / 3.2	2.5	2.5
Backing	-	-	Jute fabric	Jute fabric	Jute fabric
Thickness of cork / foam backing	EN ISO 24340	mm	-	-	-
Weight	EN ISO 23997	g/sqm	2400 / 2900 / 3800	2900	2900
Width of sheet	EN ISO 24341	cm	200	200	200
Length of sheet	EN ISO 24341	m	20-31	20-31	20-31
<b>CLASSIFICATION</b>					
Norm / Product specification	-	-	EN ISO 24011	EN ISO 24011	EN ISO 24011
European classification	EN ISO 10874	class	23 / 34 / 43 23 / 32 / 41 in 2.0 mm	23 / 34 / 43	23 / 34 / 43
Fire rating	EN 13501-1	class	Cfl-s1 <sup>(1)</sup>	Cfl-s1 <sup>(1)</sup>	Cfl-s1 <sup>(1)</sup>
Slip resistance	ASR A1.5 / DIN 51130 – BGR 181	class	R9	R9	R9
Barefoot slipping	DIN 51097	class	-	-	-
Impact sound insulation	EN ISO 717-2	dB	3 dB / 5 dB / 6 dB	5 dB	5 dB
<b>PERFORMANCES</b>					
Residual indentation	EN ISO 24343-1	mm	≤ 0.09 / ≤ 0.11 / ≤ 0.11	≤ 0.11	≤ 0.11
Colour fastness	EN ISO 105 - B02	degree	6	6	6
Vertical resistance	EN 1081	Ohm	-	-	-
Point contact resistance	VDE 0100	kOhm	> 200	> 200	> 200
Static electrical propensity	EN 1815	kV	≈ 2.0	≈ 2.0	≈ 2.0
Castor chair test [Type H]	ISO 4918	-	OK	OK	OK
Flexibility	ISO 24344	mm	Ø 20 (2,5 mm)	Ø 20	Ø 20
Thermal resistance	EN 12667	sqm,K/W	0.012 / 0.015 / 0.018	0.015	0.015
Thermal conductivity	EN ISO 10456	W/(m.K)	0.17	0.17	0.17
Surface treatment	-	-	Neocare™	Neocare™	Neocare™
Chemical products resistance	EN ISO 26987	class	OK	OK	OK
Anti-bacterial activity (E. coli – S. aureus – MRSA) after 24 hours <sup>(2)</sup>	EN ISO 22196 / JIS Z 2801	-	> 99.99% inhibits growth	> 99.99% inhibits growth	> 99.99% inhibits growth
Anti-viral activity (Human coronavirus) after 5h <sup>(2)</sup>	ISO 21702	-	> 98.65% virucidal activity	> 98.65% virucidal activity	> 98.65% virucidal activity
<b>INDOOR AIR QUALITY</b>					
TVOC after 28 days	EN 16516	microgram/m <sup>3</sup>	< 10	< 10	< 10
<b>CIRCULAR ECONOMY</b>					
Certification	Cradle to Cradle	-	Silver	Silver	Silver
<b>CE MARKING</b>					
	EN 14041: 2004 AC: 2006	-			

(1) Glued according to certificate.

(2) The implementation of an effective cleaning method is the best defense against infection.

DOP numbers available from your local branch.



Depending on light exposure, the product color can vary, due to linoleum natural oxidization process. This process is reversible. We recommend that the samples be exposed to sunlight for several hours prior to making a final color choice.

UNI WALTON	LINO ART URBAN / FLOW / METALLIC / STAR	MARMORETTE ACOUSTICPLUS 19dB	COLORETTE ACOUSTICPLUS 19dB	MARMORETTE ACOUSTIC 15dB	LINODUR	MARMORETTE LCH
2.5	2.5	4.0	4.0	4.0	4.0	2.5
Jute fabric	Jute fabric	Foam backing	Foam backing	Cork and jute fabric	Jute fabric	Jute fabric
-	-	1.5	1.5	2.0	-	-
2900	2900	3500	3500	3900	4700	3000
200	200	200	200	200	200	200
20-31	20-31	20-31	20-31	20-31	20-31	20-31
EN ISO 24011	EN ISO 24011	EN 686	EN 686	EN 687	EN ISO 24011	EN ISO 24011
23 / 34 / 43	23 / 34 / 43	23 / 33 / 41	23 / 33 / 41	23 / 33 / 41	23 / 34 / 43	23 / 34 / 43
C <sub>ft-s1</sub> <sup>(1)</sup>	C <sub>ft-s1</sub> <sup>(1)</sup>	C <sub>ft-s1</sub> <sup>(1)</sup>	C <sub>ft-s1</sub> <sup>(1)</sup>	C <sub>ft-s1</sub> <sup>(1)</sup>	C <sub>ft-s1</sub> <sup>(1)</sup>	C <sub>ft-s1</sub> <sup>(1)</sup>
R9	R9	R9	R9	R9	R9	R9
-	-	-	-	-	A	-
5 dB	5 dB	19 dB	19 dB	15 dB	6 dB	3 dB
≤ 0.11	≤ 0.11	≤ 0.30	≤ 0.30	≤ 0.40	≤ 0.20	≤ 0.11
6	6	6	6	6	6	6
-	-	-	-	-	-	10 <sup>6</sup> ≤ R ≤ 10 <sup>8</sup>
> 200	> 200	> 200	> 200	> 200	> 200	> 100
≈ 2.0	≈ 2.0	2.0	2.0	2.0	2.0	2.0
OK	OK	OK	OK	OK	OK	OK
Ø 20	Ø 20	-	-	-	-	-
0.015	0.015	0.044	0.044	0.04	0.023	0.015
0.17	0.17	0.0937	0.0937	0.17	0.17	0.17
Neocare™	Neocare™	Neocare™	Neocare™	Neocare™	LPX	LPX
OK	OK	OK	OK	OK	OK	OK
> 99.99% inhibits growth	> 99.99% inhibits growth	> 99.99% inhibits growth	> 99.99% inhibits growth	> 99.99% inhibits growth	> 99.99% inhibits growth	> 99.99% inhibits growth
> 98.65% virucidal activity	> 98.65% virucidal activity	> 98.65% virucidal activity	> 98.65% virucidal activity	> 98.65% virucidal activity	-	-
< 10	< 10	< 10	< 10	< 10	-	-
Silver	Silver	Bronze	Bronze	Silver	-	-



# COMPACT LINOLEUM

MARMORETTE / ARABESQUE /  
COLORETTE / UNI WALTON / LINO ART

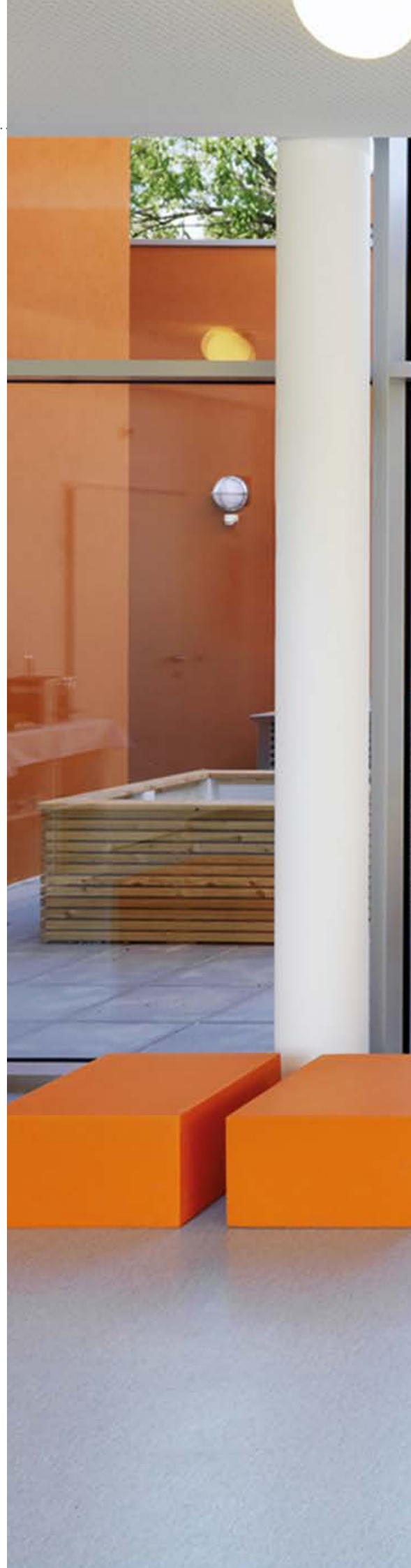
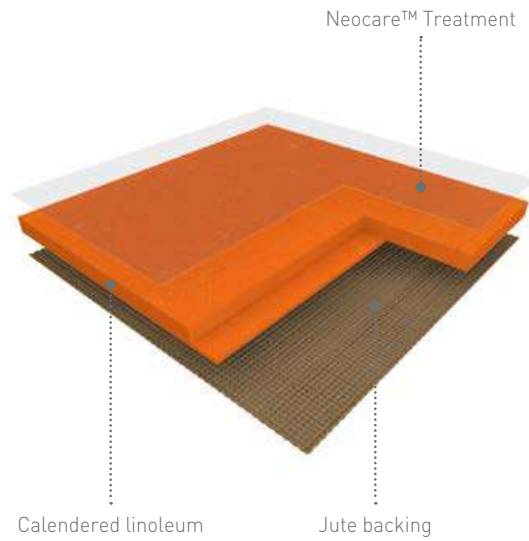





## MARMORETTE / ARABESQUE / COLORETTE / UNI WALTON / LINO ART

**MARMORETTE** is a calendered linoleum compact floorcovering in sheet, 2 m wide, providing excellent resistance to everyday wear and tear in high traffic areas. Its weight is 2400 g/sqm in 2.0 mm, 2900 g/sqm in 2.5 mm and 3800 g/sqm in 3.2 mm. It features a marbled design and presents a matt finish, is composed of 98% natural materials (linseed oil, wood flour, resins, cork, minerals and jute fabric) among of which 76% are rapidly renewable.

**ARABESQUE** is a calendered linoleum compact floorcovering in sheet, 2 m wide, providing excellent resistance to everyday wear and tear in high traffic areas. Its weight is 2900 g/sqm in 2.5 mm. It features a marbled design and presents a matt finish, is composed of 98% natural materials (linseed oil, wood flour, resins, cork, minerals and jute fabric) among of which 76% are rapidly renewable.

**COLORETTE** is a calendered linoleum compact floorcovering in sheet, 2 m wide, providing excellent resistance to everyday wear and tear in high traffic areas. Its weight is 2900 g/sqm in 2.5 mm. It features a speckled design and presents a matt finish, is composed of 98% natural materials (linseed oil, wood flour, resins, cork, minerals and jute fabric) among of which 76% are rapidly renewable.

**UNI WALTON** is a calendered linoleum compact floorcovering in sheet, 2 m wide, providing excellent resistance to everyday wear and tear in high traffic areas. Its weight is 2900 g/sqm in 2.5 mm. It features a uni design and presents a matt finish, is composed of 98% natural materials (linseed oil, wood flour, resins, cork, minerals and jute fabric) among of which 76% are rapidly renewable.

**LINO ART** is a calendered linoleum compact floorcovering in sheet, 2 m wide, providing excellent resistance to everyday wear and tear in high traffic areas. Its weight is 2900 g/sqm in 2.5 mm. It features a striated design (FLOW), a scattered metallic design (METALLIC), a scattered colour chips design (STAR), a concrete design (URBAN) and presents a matt finish, is composed of 98% natural materials (linseed oil, wood flour, resins, cork, minerals and jute fabric) among of which 76% are rapidly renewable.

### ARABESQUE, COLORETTE, MARMORETTE, UNI WALTON, LINO ART

The floorings are produced with Neocare™ solvent-free surface treatment, an exclusive photo-cured acrylate based lacquer surface treatment obtained by triple laser UV cross linking. Neocare™ offers excellent scratch resistance as well as resistance to chemicals found in aggressive environments such as bleach, hydro alcoholic solutions, Betadine and Eosin as well as markers making maintenance easier and increasing the life of the flooring. This treatment avoids performing any polishing throughout the lifetime of the product. It can however be polished following usual recommendations and according to the customer's wishes.

The products ensure perfect indoor air quality (TVOC at 28 days [EN 16516] < 10 microgram/m<sup>3</sup>) and are classified A+ (the best class) in the context of health labeling. It is Floorscore®, M1 and Blue Angel certified.

The floorings are 100% recyclable, are composed of minimum 25% recycled content and up to 40% recycled content, 100% controlled, are REACH compliant and rated Cfl-s1 for fire resistance.

Designed and manufactured in a sustainable way in a plant awarded with ISO 9001 (quality), ISO 14001 (environment) and ISO 50001 (energy) certifications, the floorings are Cradle to Cradle certified™ Silver. They are Environmental Performance Declaration (EPD) certified by an external laboratory indicating carbon neutrality during the first stages of their life cycle ("from cradle to gate").

The Camouflage [Arabesque, Marmorette] or Uni [Colorette, Uni Walton, Lino Art] welding rod makes the connections between the strips invisible. They are antistatic, anti-bacterial according to ISO 22196 / JIS Z 2801 and anti-viral according to ISO 21702.

# COMPACT LINOLEUM

## MARMORETTE



Neocare™

2.0 mm

2.5 mm

3.2 mm



0056 Foggy Blue  
2.0 mm / 2.5 mm / 3.2 mm



0253 Pebble Grey  
2.5 mm



0252 Light Grey  
2.5 mm



0251 Cream  
2.5 mm



0053 Ice Grey **A A+**  
2.0 mm / 2.5 mm / 3.2 mm



0254 Mineral Grey  
2.5 mm



0155 Smoked Pearl  
2.5 mm



0106 Hazelnut Shake  
2.5 mm



0055 Ash Grey  
2.0 mm / 2.5 mm / 3.2 mm



0166 Clay  
2.5 mm



0091 Shiitake Mushroom  
2.5 mm



0146 Beeswax Beige  
2.5 mm



0054 Concrete Patty  
2.5 mm



0158 Tabac Grey  
2.5 mm



0153 Greystone Grey  
2.5 mm



0090 Soapstone  
2.5 mm



0160 Industrial Grey  
2.0 mm / 2.5 mm



0050 Quartz Grey  
2.0 mm / 2.5 mm / 3.2 mm



0164 Milk Coffee  
2.5 mm



0003 Dark Brown  
2.5 mm

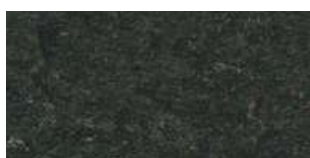

0096 Midnight Grey  
2.5 mm



0059 Plumb Grey **A A+**  
2.0 mm / 2.5 mm / 3.2 mm



0108 Mokka Brown  
2.5 mm



0089 Peacan Pie  
2.5 mm

**A** Acoustic 15 dB in stock

**A+** AcousticPlus 19 dB in stock

All colours can be manufactured in Acoustic 15 dB version. Special request - Minimum order quantity: 1200 sqm. Below 1200 sqm, use Korkment underlayer.  
All colours can be manufactured in AcousticPlus 19 dB version. Special request - Minimum order quantity: 60 sqm.

# MARMORETTE



Neocare™

2.0mm

2.5mm

3.2mm



0070 Rocky Brown **A+**  
2.0 mm / 2.5 mm / 3.2 mm

^ Scale 1



0092 Beach  
2.5 mm



0040 Light Sahara **A+**  
2.0 mm / 2.5 mm



0042 Shortcrust  
2.5 mm



0072 Golden Yellow  
2.5 mm



0172 Papaya Orange  
2.5 mm



0076 Pale Yellow  
2.5 mm



0098 Desert Beige **A**  
2.0 mm / 2.5 mm



0073 Spicy Orange **A+**  
2.5 mm



0173 Melon Orange  
2.5 mm



0243 Marble Beige  
2.5 mm



0045 Sand Beige **A**  
2.0 mm / 2.5 mm



0117 Mandarin Orange  
2.5 mm



0118 Chili Red  
2.5 mm



0018 Lobster Red  
2.5 mm

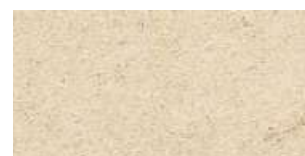

0145 Banana White  
2.5 mm



0119 Terracotta  
2.5 mm



0019 Sunset Orange **A**  
2.5 mm



0075 Light Aurora  
2.5 mm



0211 Pink  
2.5 mm



# COMPACT LINOLEUM

## MARMORETTE



0130 Antique Green  
2.5 mm **A+**



0049 Royal Blue  
2.5 mm / 3.2 mm



0121 Blue Eyes  
2.5 mm



0100 Frog Green  
2.5 mm



0043 Leaf Green  
2.5 mm



0148 Ink Blue  
2.5 mm



0023 Dusty Blue  
2.0 mm / 2.5 mm / 3.2 mm **A**



0132 Lime Green  
2.5 mm



0099 Grey Turquoise  
2.5 mm



0128 Violet  
2.5 mm



0122 Fluffy Blue  
2.5 mm



0138 Khaki  
2.5 mm



0022 Autumn Blue  
2.5 mm / 3.2 mm **A+**



0224 Mystery Blue  
2.5 mm



0026 Sky Blue  
2.5 mm



0083 Jungle  
2.5 mm



0136 Turquoise Bay  
2.5 mm



0149 Dark Blue  
2.5 mm



0028 Dive  
2.5 mm



0129 Curacao Petrol



0129 Curacao Petrol  
2.5 mm **A+**

^ Scale 1

**A** Acoustic 15 dB in stock

**A+** AcousticPlus 19 dB in stock

All colours can be manufactured in Acoustic 15 dB version. Special request - Minimum order quantity: 1200 sqm. Below 1200 sqm, use Korkment underlayer.  
All colours can be manufactured in AcousticPlus 19 dB version. Special request - Minimum order quantity: 60 sqm.

# ARABESQUE



Neocare™

2.5 mm



0304 Seravezza



0302 Antico  
2.5 mm



0305 Monarca  
2.5 mm

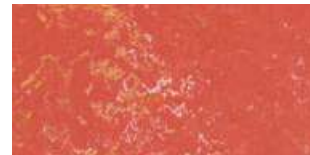

0303 Verona  
2.5 mm



0306 Prato  
2.5 mm



0301 Alcino  
2.5 mm



0304 Seravezza  
2.5 mm

^ Scale 1

All colours can be manufactured in Acoustic 15 dB version. Special request - Minimum order quantity: 1200 sqm. Below 1200 sqm, use Korkment underlayer.  
All colours can be manufactured in AcousticPlus 19 dB version. Special request - Minimum order quantity: 60 sqm.



# COMPACT LINOLEUM

## COLORETTE



0001 Banana Yellow  
2.5 mm



^ Scale 1



0055 Oxid Grey  
2.5 mm



0071 Straw Beige  
2.5 mm



0073 Sand Yellow  
2.5 mm



0132 Spicy Green  
2.5 mm



0059 Stone Grey  
2.5 mm



0058 Aluminium Grey  
2.5 mm



0171 Sunrise Orange  
2.5 mm



0006 Vivid Green  
2.5 mm



0080 Elephant Grey  
2.5 mm

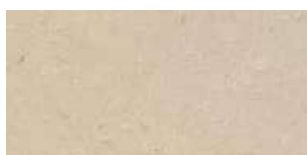

0012 Light Beige  
2.5 mm



0016 Deep Orange  
2.5 mm



0123 Poppy Blue  
2.5 mm



0081 Private Black  
2.5 mm

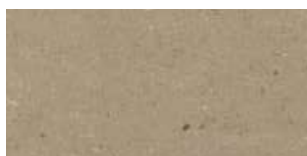

0043 Light Mud  
2.5 mm



0170 Kumquat Orange  
2.5 mm



0004 Bluebird  
2.5 mm



0118 Power Red  
2.5 mm



0110 Cadillac Pink  
2.5 mm



**A+** : AcousticPlus 19 dB in stock

All colours can be manufactured in Acoustic 15 dB version. Special request - Minimum order quantity: 1200 sqm. Below 1200 sqm, use Korkment underlayer.



# UNI WALTON



Neocare™



0100 Ocean Blue

0100 Ocean Blue  
2.5 mm

^ Scale 1



0062 Mediterranean Orange  
2.5 mm

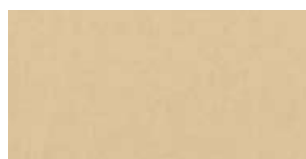

0043 Neutral Beige  
2.5 mm



0059 Frost Grey  
2.5 mm



0095 Spring Blue  
2.5 mm



0010 Pompeji Red  
2.5 mm



0085 Warm Concrete Grey  
2.5 mm

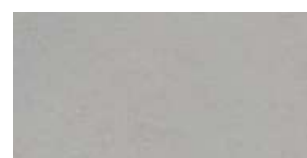

0081 Nickel Grey  
2.5 mm



0083 Architects Grey  
2.5 mm



0088 Chestnut  
2.5 mm



0090 Olive  
2.5 mm



0082 Broken Grey  
2.5 mm

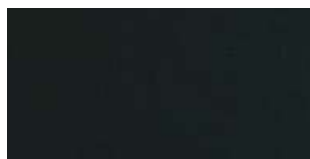

0080 Black  
2.5 mm



0060 Deep Brown  
2.5 mm



0058 Clay Grey  
2.5 mm



0035 Racing Green  
2.5 mm

DLW  
Linoleum

All colours can be manufactured in Acoustic 15 dB version. Special request - Minimum order quantity: 1200 sqm. Below 1200 sqm, use Korkment underlayer.  
All colours can be manufactured in AcousticPlus 19 dB version. Special request - Minimum order quantity: 60 sqm.

# COMPACT LINOLEUM

## LINO ART URBAN



Neocare™

2.5 mm



0554 Concrete Grey



0551 Flashy Asphalt Grey  
2.5 mm

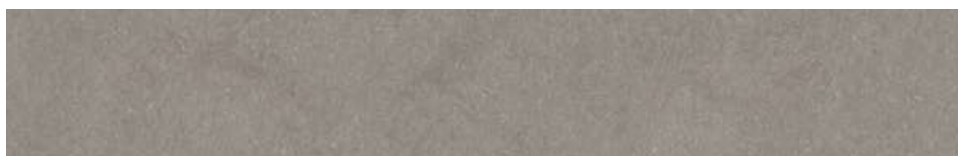

0554 Concrete Grey  
2.5 mm

^ Scale 1



0552 Silver Grey  
2.5 mm

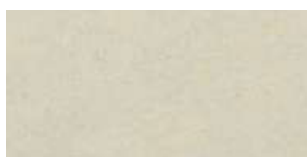

0564 Natural Stone  
2.5 mm



0555 Flashy Street Grey  
2.5 mm

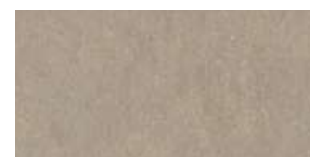

0550 Beton Soft Grey  
2.5 mm



0567 Shining Green  
2.5 mm



0566 Mud Grey  
2.5 mm



0557 Urban Grey  
2.5 mm

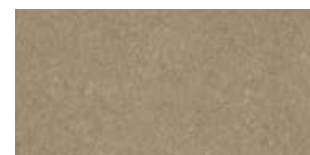

0558 Screed Grey  
2.5 mm



0566 Shining Blue  
2.5 mm



0562 Titan Grey  
2.5 mm



0560 Bold Grey  
2.5 mm

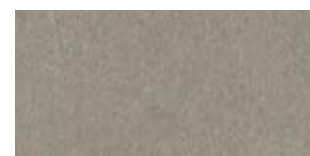

0559 Vintage Grey  
2.5 mm



0565 Graphite Grey  
2.5 mm



0563 Zinc Grey  
2.5 mm



0553 Dark Concrete Grey  
2.5 mm



0561 Pitch Black  
2.5 mm

All colours can be manufactured in Acoustic 15 dB version. Special request - Minimum order quantity: 1200 sqm. Below 1200 sqm, use Korkment underlayer.  
All colours can be manufactured in AcousticPlus 19 dB version. Special request - Minimum order quantity: 60 sqm.

# LINO ART STAR



Neocare™

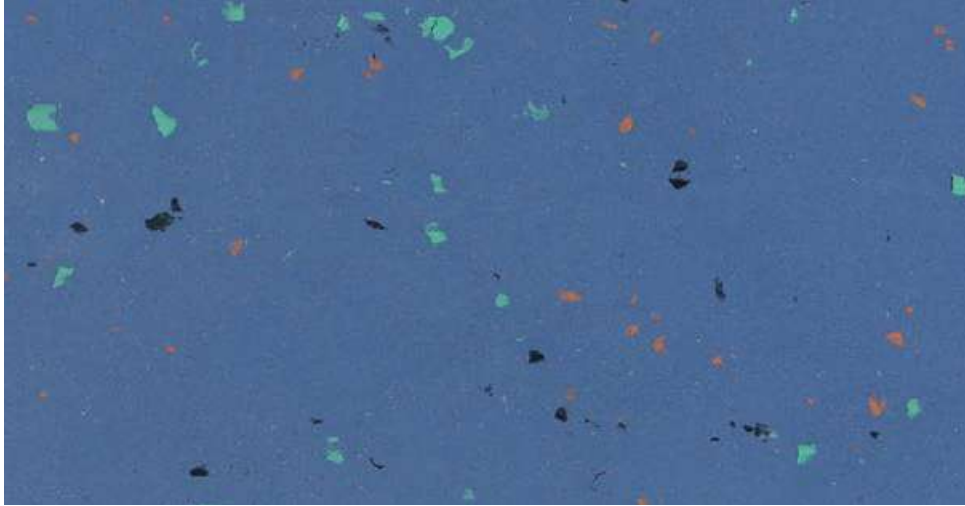

0025 Clear Blue  
2.5 mm

^ Scale 1

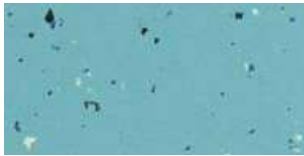

0020 Aqua Turquoise  
2.5 mm

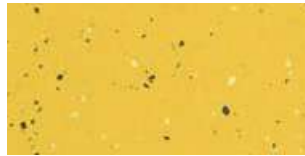

0001 Lemon Yellow  
2.5 mm



0092 Stratiatella  
2.5 mm

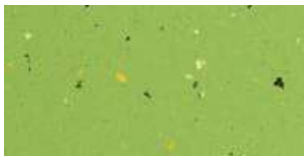

0030 Apple Green  
2.5 mm



0075 Apricot  
2.5 mm



0059 Dusty Grey  
2.5 mm

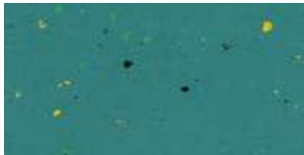

0023 Blue Turquoise  
2.5 mm

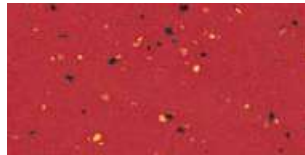

0015 Glaring Red  
2.5 mm



0090 Smooth Grey  
2.5 mm



0094 Bubble Gum  
2.5 mm



0085 Mid Grey  
2.5 mm



# COMPACT LINOLEUM

## LINO ART METALLIC



Neocare™

2.5 mm

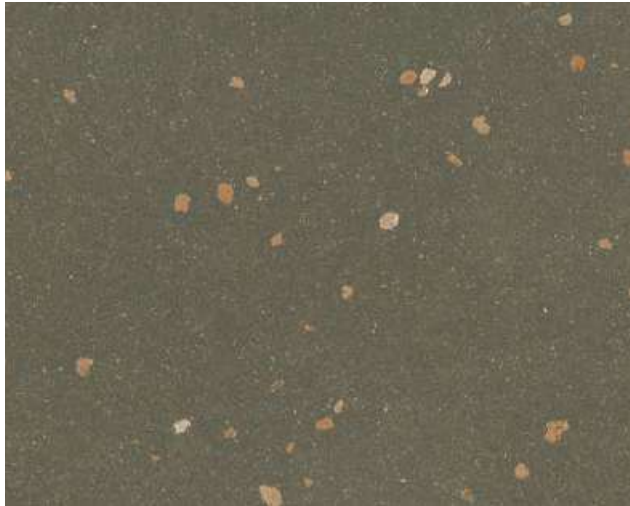

0072 Olive Green  
2.5mm

^ Scale 1



0078 Petrol Blue  
2.5mm



0070 Cool Grey  
2.5mm



0083 Aluminio Light Grey  
2.5mm



0068 Bottle Green  
2.5mm



0074 Burned Siena  
2.5mm



0080 Firmament Black  
2.5mm



0076 Salsa  
2.5mm



0072 Olive Green

# LINO ART FLOW



Neocare™



0030 Rain  
2.5mm

^ Scale 1



0030 Rain



0012 Waterfall  
2.5mm



0048 Travertin  
2.5mm



0043 Pulp Greige  
2.5mm



0024 Magma  
2.5mm



0036 Shaal Concrete  
2.5mm



0050 Grey Line  
2.5mm



0005 Bamboo  
2.5mm



0162 Bark  
2.5mm



0083 Light Grey  
2.5mm

All colours can be manufactured in Acoustic 15 dB version. Special request - Minimum order quantity: 1200 sqm. Below 1200 sqm, use Korkment underlayer.  
All colors can be manufactured in AcousticPlus 19 dB version. Special request - Minimum order quantity: 60 sqm.

# ACOUSTIC LINOLEUM

## MARMORETTE ACOUSTICPLUS / COLORETTE ACOUSTICPLUS

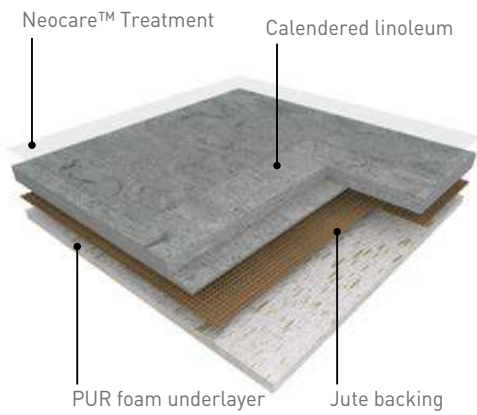

## MARMORETTE ACOUSTIC

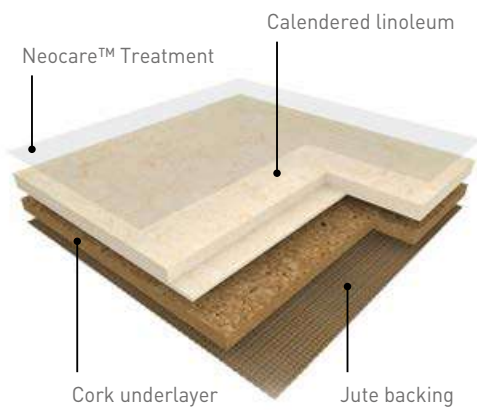

## KORKMENT: CORK ACOUSTIC UNDERLAYER







## MARMORETTE ACOUSTICPLUS COLORETTE ACOUSTICPLUS

**MARMORETTE ACOUSTICPLUS** is a calendered linoleum acoustic floorcovering in sheet, 2 m wide, providing excellent resistance to everyday wear and tear in high traffic areas. Its weight is 3500 g/sqm in 4.0 mm.

It features a marbled design and presents a matt finish, is composed of natural materials (linseed oil, wood flour, resins, cork, minerals and jute fabric), rapidly renewable and features a 1.5 mm recycled foam underlayer, ensuring up to 19 dB impact sound reduction.

**COLORETTE ACOUSTICPLUS** is a calendered linoleum acoustic floorcovering in sheet, 2 m wide, providing excellent resistance to everyday wear and tear in high traffic areas.

Its weight is 3500 g/sqm in 4.0 mm.

It features a speckled design and presents a matt finish, is composed of natural materials (linseed oil, wood flour, resins, cork, minerals and jute fabric), rapidly renewable and features a 1.5 mm recycled foam underlayer, ensuring up to 19 dB impact sound reduction.

## MARMORETTE ACOUSTIC

**MARMORETTE ACOUSTIC** is a calendered linoleum acoustic floorcovering in sheet, 2 m wide, providing excellent resistance to everyday wear and tear in high traffic areas.

Its weight is 3900 g/sqm in 4.0 mm. It features a marbled design and presents a matt finish, is composed of natural materials (linseed oil, wood flour, resins, cork, minerals and jute fabric), rapidly renewable and features a 2 mm cork underlayer, ensuring up to 15 dB impact sound reduction.

## ACOUSTIC LINOLEUM

The floorings are produced with Neocare™ solvent-free surface treatment, an exclusive photo-cured acrylate based lacquer surface treatment obtained by triple laser UV cross linking. Neocare™ offers excellent scratch resistance as well as resistance to chemicals found in aggressive environments such as bleach, hydro alcoholic solutions, Betadine and Eosin as well as markers making maintenance easier and increasing the life of the flooring. This treatment avoids performing any polishing throughout the lifetime of the product. It can however be polished following usual recommendations and according to the customer's wishes. The products ensure perfect indoor air quality (TVOC at 28 days (EN 16516) < 10 microgram/m<sup>3</sup>) and are classified A + (the best class) in the context of health labeling. They are Floorscore®, M1 and Blue Angel certified. The floorings are 100% recyclable, are composed of minimum 25% recycled content and up to 40% recycled content, 100% controlled, are REACH compliant and rated CfI-s1 for fire resistance.

Designed and manufactured in a sustainable way in a plant awarded with ISO 9001 (quality), ISO 14001 (environment) and ISO 50001 (energy) certifications, the floorings are Cradle to Cradle certified™ Bronze (Marmorette AcousticPlus, Colorette AcousticPlus) and Cradle to Cradle certified™ Silver (Marmorette Acoustic). Their Environmental Performance Declaration (EPD) certified by an external laboratory, indicate carbon neutrality during the first stages of their life cycle ("from cradle to gate").

The Camouflage (Arabesque, Marmorette) or Uni (Colorette, Uni Walton, Lino Art) welding rod makes the connections between the strips invisible.

They are antistatic, anti-bacterial according to ISO 22196 / JIS Z 2801 and anti-viral according to ISO 21702.

# ACOUSTIC LINOLEUM

## MARMORETTE ACOUSTIC



15 dB

Neocare™

4.0 mm



0019 Sunset Orange  
4.0 mm



0098 Desert Beige  
4.0 mm



0045 Sand Beige  
4.0 mm



0059 Plumb Grey  
4.0 mm



0053 Ice Grey  
4.0 mm



0023 Dusty Blue  
4.0 mm

*All other colours can be manufactured in Acoustic 15 dB version.  
Special request - Minimum order quantity: 1200 sqm. Below 1200 sqm, use Korkment underlayer.  
All other colours can be manufactured in AcousticPlus 19 dB version. Special request - Minimum order quantity: 60 sqm.*

## MARMORETTE ACOUSTICPLUS



19 dB

Neocare™

4.0 mm



0129 Curacao Petrol  
4.0 mm



0130 Antique Green  
4.0 mm



0022 Autumn Blue  
4.0 mm



0073 Spicy Orange  
4.0 mm



0070 Rocky Brown  
4.0 mm



0040 Light Sahara  
4.0 mm



0096 Midnight Grey  
4.0 mm



0059 Plumb Grey  
4.0 mm



0053 Ice Grey  
4.0 mm

*All other colours can be manufactured in Acoustic 15 dB version.  
Special request - Minimum order quantity: 1200 sqm. Below 1200 sqm, use Korkment underlayer.  
All other colours can be manufactured in AcousticPlus 19 dB version. Special request - Minimum order quantity: 60 sqm.*

# COLORETTE ACOUSTICPLUS



19 dB

Neocare™

4.0 mm



0001 Banana Yellow  
4.0 mm



0170 Kumquat Orange  
4.0 mm



0110 Cadillac Pink  
4.0 mm



0132 Spicy Green  
4.0 mm

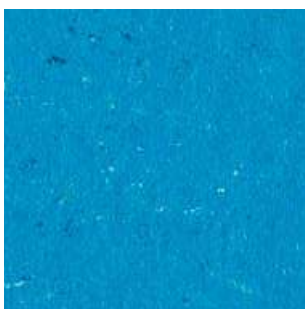

0123 Poppy Blue  
4.0 mm

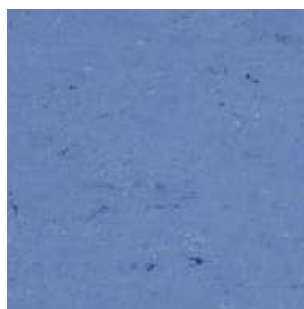

0004 Bluebird  
4.0 mm



0012 Light Beige  
4.0 mm

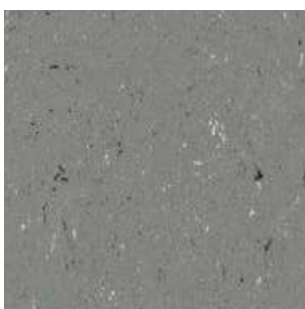

0059 Stone Grey  
4.0 mm



0080 Elephant Grey  
4.0 mm

*All other colours can be manufactured in Acoustic 15 dB version.*

*Special request - Minimum order quantity: 1200 sqm. Below 1200 sqm, use Korkment underlayer.*

*All other colours can be manufactured in AcousticPlus 19 dB version. Special request - Minimum order quantity: 60 sqm.*



# TECHNIC LINOLEUM

## LINODUR - HIGH MECHANICAL TRAFFIC RESISTANCE

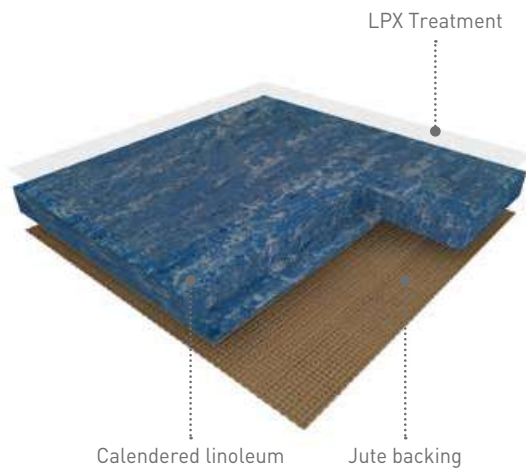

**LINODUR** is a calendered linoleum compact floorcovering in sheet, 2 m wide, providing excellent resistance to everyday wear and tear in high pedestrian and mechanical traffic areas and has been designed to resist a 30 kg/sqm dynamic load. Its weight is 4700 g/sqm in 4.0 mm.

It features a moiré design and is composed of 98% natural materials (linseed oil, wood flour, resins, cork, minerals and jute fabric) among of which 76% are rapidly renewable.

The flooring is equipped with LPX surface treatment, making the maintenance easy and the flooring long lasting.

The Camouflage welding rod makes the connections between the strips invisible.

It is antistatic, anti-bacterial according to ISO 22196 / JIS Z 2801. The flooring is 100% recyclable, is composed of minimum 25% recycled content and up to 40% recycled content, 100% controlled, is REACH compliant and rated Cfl-s1 for fire resistance.

This product is manufactured in a plant awarded with ISO 9001 (quality), ISO 14 001 (environment) and ISO 50001 (energy) certifications. The product also benefits from international certifications such as Floorscore® and Blue Angel (emissions).

## MARMORETTE LCH - DISSIPATIVE LINOLEUM FOR ESD AREAS

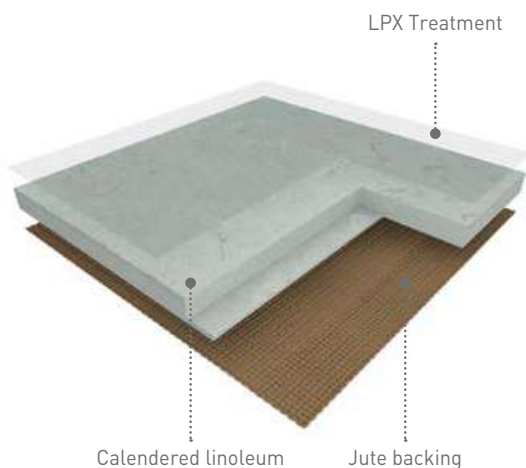

**MARMORETTE LCH** is a calendered linoleum compact dissipative floorcovering in sheet, 2 m wide, providing excellent resistance to everyday wear and tear in high traffic areas.

Its vertical resistance is  $10^6 < R < 10^8 \Omega$ .

Its weight is 3000 g/sqm in 2.5 mm.

It features a marbled design and presents a matt finish, is composed of 98% natural materials (linseed oil, wood flour, resins, cork, minerals and jute fabric) among of which 76% are rapidly renewable.

The flooring is equipped with LPX surface treatment, making the maintenance easy and the flooring long lasting.

The flooring is 100% recyclable, is composed of minimum 25% recycled content and up to 40% recycled content, 100% controlled, is REACH compliant and rated Cfl-s1 for fire resistance.

It is designed and manufactured in a sustainable way in a plant awarded with ISO 9001 (quality), ISO 14001 (environment) and ISO 50001 (energy) certifications.

The Camouflage welding rod makes the connections between the strips invisible.

It is antistatic, anti-bacterial according to ISO 22196 / JIS Z 2801.

# LINODUR - HIGH MECHANICAL TRAFFIC RESISTANCE



4.0 mm



0020 Spring Blue  
4.0 mm

^ Scale 1



0024 Speckled Blue  
4.0 mm



0056 Marble Grey  
4.0 mm



0020 Spring Blue



0081 Sporty Black  
4.0 mm



0011 Avocado Green  
4.0 mm



0072 Peach Orange  
4.0 mm

# MARMORETTE LCH - DISSIPATIVE LINOLEUM FOR ESD AREAS



$10^6 \leq R \leq 10^8 \Omega$



2.5 mm

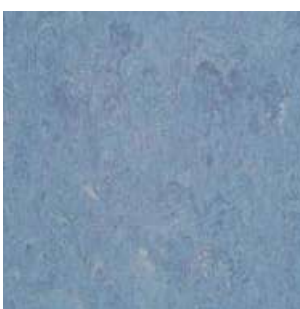

0023 Dusty Blue  
2.5 mm



0055 Ash Grey  
2.5 mm

# FINISHES

## SKIRTINGS

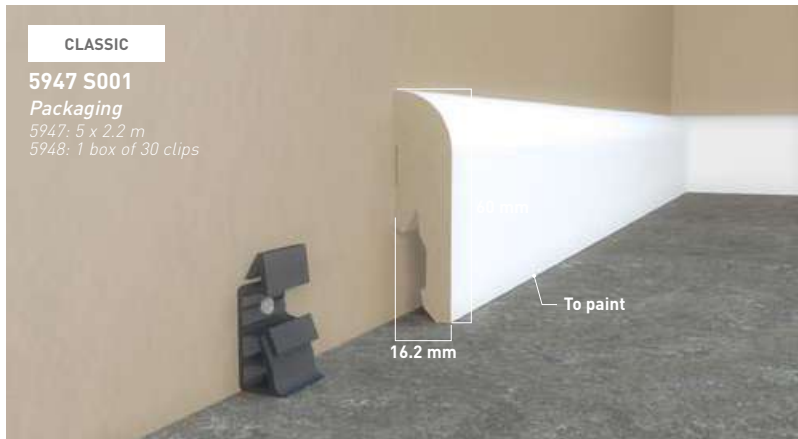

MDF

 Color: White



COVE FORMER

 Color: 6512



HSLA

## WELDING RODS

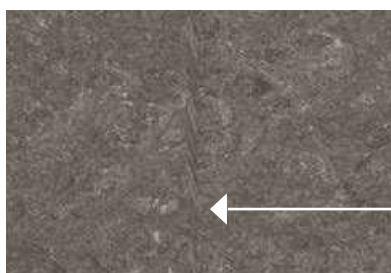

**MARMORETTE,  
 ARABESQUE &  
 LINODUR**

**Camouflage  
 welding rod:**  
 invisible joints.

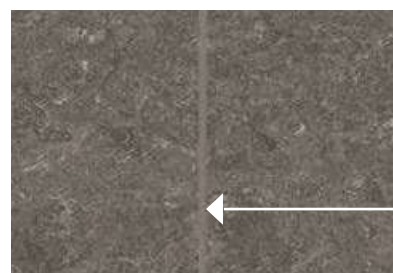

**COLORETTE,  
 UNI WALTON &  
 LINO ART**

**Uni welding rod:**  
 a large palett of colours.

Welding rod matching table available on: [gerflor.com](http://gerflor.com)



# CLEANING LINOLEUM NEOCARE TREATED FLOORS

## MARMORETTE & LCH / ARABESQUE / COLORETTE / UNI WALTON / LINO ART



### Damp sweeping equipment

Flexible mop preferably fitted with disposable, antistatic and/or pre-impregnated gauze strips



### Manual washing equipment

Disposable microfibre mop or gauze



### Single disk machine



### Autoscrubber



### Mechanical cleaning disk

3M (or equivalent) colour disks

	EQUIPMENT USED	CLEANING PRODUCTS	CLEANING METHODS
<b>First use</b>  <b>Manual or mechanical cleaning</b>	 or if soiled	Neutral detergent or Alkaline detergent	<ul style="list-style-type: none"> <li>• Damp sweeping</li> <li>• Mechanical washing at 160-200 rpm (with water recovery)</li> </ul>
<b>Daily cleaning</b>  <b>Manual cleaning</b>		Neutral detergent / Disinfectant detergent <sup>[1]</sup>	<ul style="list-style-type: none"> <li>• Damp sweeping</li> <li>• Manual washing with flat mop</li> <li>• Rinsing</li> </ul>
<b>OR</b>  <b>Mechanical cleaning</b>		Neutral detergent	<ul style="list-style-type: none"> <li>• Damp sweeping</li> <li>• Mechanical washing at 160-200 rpm (with water recovery)</li> </ul>
<b>Deep cleaning</b>  <b>Mechanical cleaning</b>		Alkaline detergent	<ul style="list-style-type: none"> <li>• Damp sweeping</li> <li>• Mechanical washing at 160-200 rpm (with water recovery)</li> </ul>

[1] In areas where disinfection is essential (e.g. operating theatres, hospital rooms, etc.), alternate between using neutral detergent and amine-free disinfectant detergent.

These cleaning instructions have to be adapted depending on traffic and location of the area.

Gerflor DLW flooring products are to be installed in full accordance with Gerflor DLW installation instructions and recognized trade standards.

An effective, regular cleaning and maintenance program is vital for retaining a high appearance level. Gerflor DLW flooring products should only be used as floorcoverings.

Note: Gerflor DLW reserve the right to amend this specification without giving prior notice. For the latest versions of the technical specifications, check our website: [www.gerflor.com](http://www.gerflor.com)

**INSTALLATION & MAINTENANCE GUIDELINES AVAILABLE ON GERFLOR.COM**



SPORTS  
FLOORINGS

PAGES

**246/281**



**Taraflex™** .....**250-263**  
Synthetic Sports Floorings

**Connor Sports®**.....**264-265**  
Hardwood flooring systems

**Sport Court®**.....**266-271**  
Outdoor Surfaces

**DLW** .....**272-277**  
Linoleum Sports Floorings

**Powershock** .....**278-280**  
Fitness rubber solutions

**Our solutions for  
your fitness center** ..... **281**



**TARAFLEX®**  
SPORTS

## INDOOR SYNTHETIC FLOORS: THE BEST PERFORMING PRODUCTS ON THE MARKET

Taraflex® has been one of the pioneer in 1947 when developing synthetic floors and is today the world leading brand for indoor sports floor.

With a complete range of products, Gerflor offers the perfect solution adapted to all users and usages, from low impact activities through to elite and performance sports.

Gerflor sets itself the highest standards when it comes to the environmental quality of its products.

TARAFLEX® SPORT FLOORS ARE  
RECOGNISED ALL OVER THE WORLD

Every day more than **6 million children** play on a Taraflex® sports floor.

**3500** high level competitions per year are played on a Taraflex® sports floor.



# WHERE CHAMPIONS PLAY



HARDWOOD FLOORING SYSTEMS:  
MORE THAN 100 YEARS  
OF EXPERIENCE



Founded in 1872, Connor Sports® is the market leader in portable and permanent hardwood sports flooring systems.

Connor Sports® professional engineers lead the industry in new product design and development, setting the standard for innovative solutions in sports surfacing.

In 1914, Connor Sports® installed the first basketball court in the USA.

In the late 90's, Boston Celtics selected Connor Sports® to repurpose their famed parquet into a portable flooring system.



OUTDOOR SURFACES:  
WORLD'S LEADING OUTDOOR  
SPORT SURFACE



In 1974, Sport Court® created the outdoor game court. Since then, over 150,000 courts have been installed worldwide.

Sport Court®'s superior outdoor play surface is designed to:

- keep athletes safe
- allow for year-round sports activity
- eliminate costly annual maintenance



INDOOR SPORT AREAS:  
HISTORIC LEADER  
IN LINOLEUM SPORT FLOORING



DLW Linoleum has been manufacturing high class sport linoleum for over 30 years and is proud to deliver uncompromising product quality.

Adapted to both specific and multi-function use, linoleum high performance floors are a great option to address various applications, from kindergartens to multipurpose halls and fitness centres.

Thanks to its acknowledged sustainable features, millions of square metres of sport linoleum have been installed over the years and still convince new generations of users.







# TABLE OF CONTENTS

252-253	WHY SHOULD YOU CHOOSE TARAFLEX®?
254-255	HOW TO CHOOSE THE RIGHT FLOOR?
256-257	A LARGE PALETTE OF COLOURS AND DESIGNS
258	RACKET SPORTS
259	DISABILITY AND ROLLING SPORTS
260-261	ALL YOU NEED TO KNOW
262-263	INNOVATIVE SERVICES TO MAKE YOUR FLOOR UNIQUE

# WHY SHOULD YOU

## 1 FOR PERFORMANCE

### 1 **Protocolsol**<sup>TRIPLE ACTION®</sup>

An intelligent surface with the unique and patented triple action Protocolsol®:

- ▶ Best solution to maximise both slide and grip.
- ▶ A friction-burn free surface, on which the temperature during a fall is reduced by 25%.
- ▶ Cost effective and easy to maintain.

### 2 **D-Max**<sup>DURABILITY™</sup>

**D-Max™** surface is a UNIQUE complex made up of calendered PVC sheets reinforced with a fibreglass grid.

- ▶ High durability
- ▶ Outstanding dimensional stability

### 3 **CXP**<sup>COMFORT™</sup>**HD**

**Taraflex® Double Density Technology**

- ▶ Best shock absorption properties

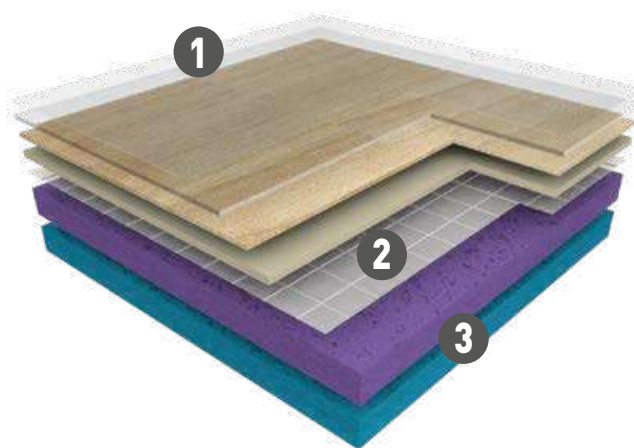

## 2 FOR PROTECTION

The floor that brings **immediate protection on impact** to all users when falling, diving or sliding on the floor.

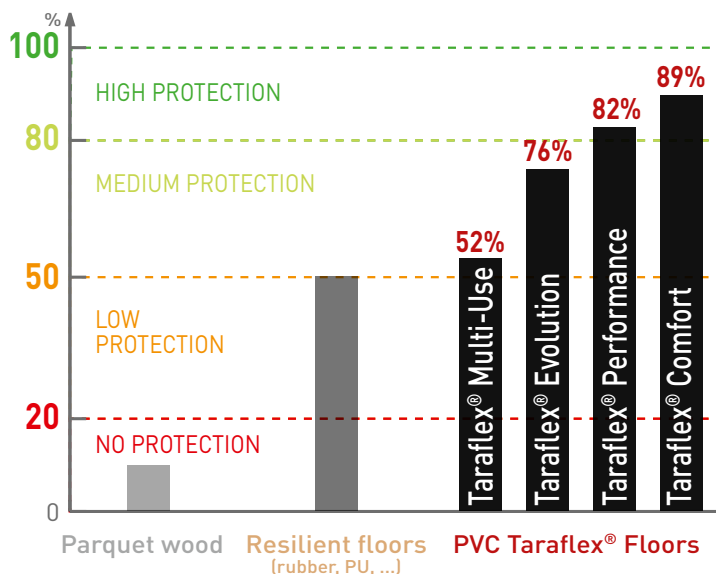

Gerflor offers Taraflex® Comfort, a P3 floor with **the highest level of comfort on the market.**

# CHOOSE TARAFLEX®?

## 3 FOR SAFETY

Shock absorption **minimises the force** of impact on the body and reduces long term injury risk.

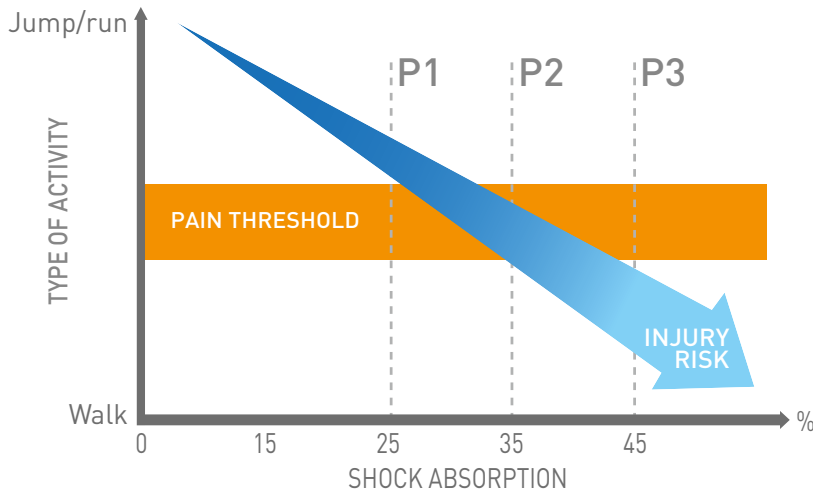

With a complete range of shock absorption P1/P2/P3, Gerflor provides the right solution and the best safety for every user.

## 4 FOR DURABILITY

Taraflex® technologies ensure long-lasting **HIGH PERFORMANCE**

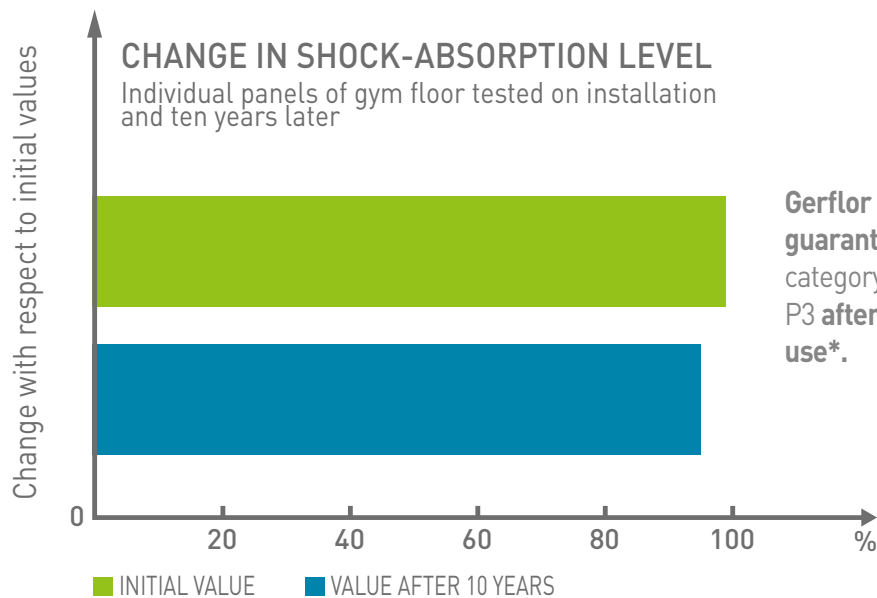

Gerflor guarantees the category P1/P2/P3 after 10 years use\*.

\*Gerflor's internal ageing tests

Sports  
Floorings

## PARTNER OF MAJOR SPORTS EVENTS





## MULTI SPORT

EDUCATION, CLUB & COMPETITION

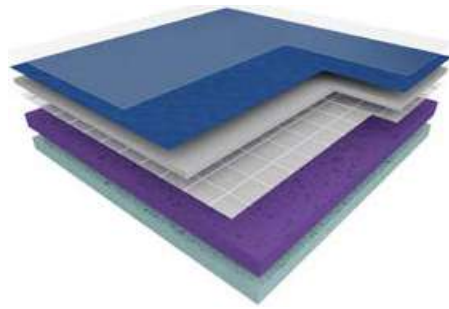

### TARAFLEX® EVOLUTION

THE REFERENCE IN SPORTS FLOORING



ALSO AVAILABLE WITH  
**Dry-Tex™**



### TARAFLEX® PERFORMANCE

BEST BALANCE OF SPORT PERFORMANCE AND SAFETY



ALSO AVAILABLE WITH  
**Dry-Tex™**

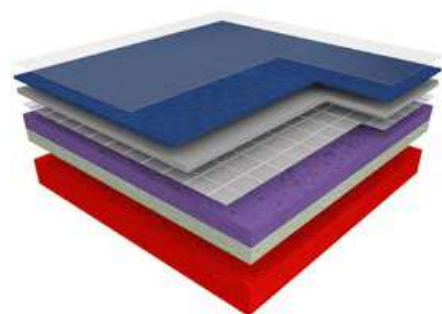

### TARAFLEX® COMFORT

MAXIMUM PROTECTION & SAFETY



P1, P2, P3: point elastic sports flooring classification according to EN 14904

# THE RIGHT FLOOR?

## MULTI PURPOSE

### SPORT & NON-SPORT ACTIVITIES

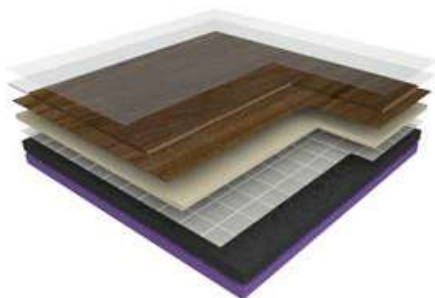

TARAFLEX®  
**MULTI-USE**  
VERY HIGH RESISTANCE TO LOADS

P1  6.2 mm



## HEAVY DUTY MULTI PURPOSE

### HEAVY LOAD RESISTANCE AND SHOCK ABSORPTION

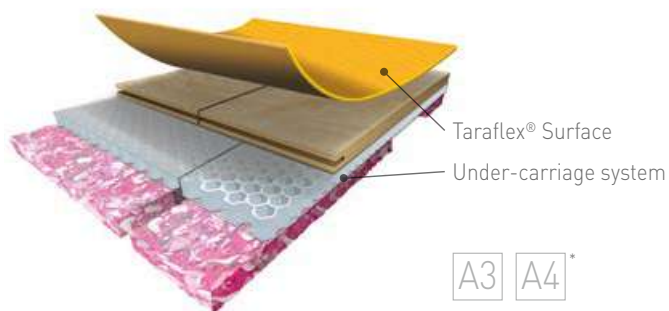

A3 A4\*

\*DEPENDING ON THE UNDER-CARRIAGE SYSTEM



# A LARGE PALETTE

## NATURAL AND VIBRANT COLOURS FOR MULTISPORTS

ALL COLOURS ARE AVAILABLE WITH  
TARAFLEX® SURFACE  
TARAFLEX® PERFORMANCE

TARAFLEX® COMFORT  
AND TARAFLEX® EVOLUTION



6381 - Maple Design / Y = 38.5



5742 Wood Oak / Y = 26.3



6350 - Light Cherry Design / Y = 43.3



6445 - Lagoon / Y = 24.9

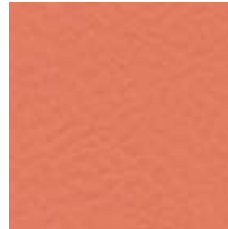

6146 - Coral / Y = 27.8



6180 - Red / Y = 9.8

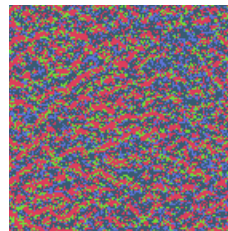

6038 - Terracotta / Y = 19.9

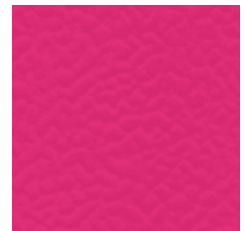

6159 - Pink / Y = 19.1



6430 - Blue / Y = 8.0



6431 - Teal / Y = 19.2



6758 - Silver Gray / Y = 32.6

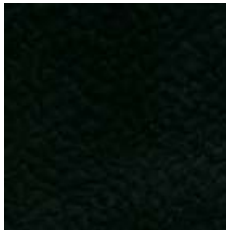

6830 - Black / Y = 3.1



6570 - Mint Green / Y = 16.6



6559 - Spring / Y = 47.1

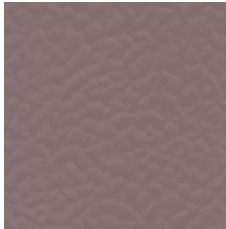

3764 - Taupe / Y = 17.9

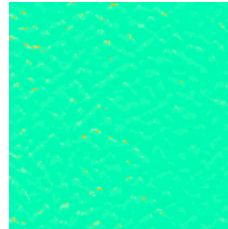

6211 - Gold / Y = 41.5

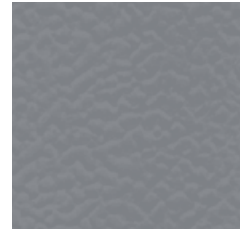

6873 - Anthracite / Y = 20.5

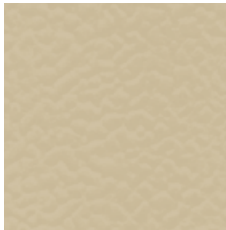

6347 - Beige / Y = 39.7

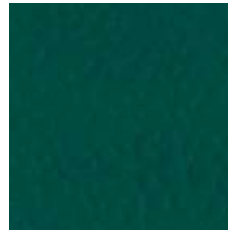

6557 - Forest / Y = 10.9



2404 - London Light Blue / Y = 33.8



# OF COLOURS AND DESIGNS

## MODERN AND URBAN DESIGNS FOR MULTI-ACTIVITIES

ALL COLOURS ARE AVAILABLE WITH  
TARAFLEX® MULTI-USE



4453 - Wood Blue / Y = 17.9



6844 - Black Strips / Y = 14.5



3708 - Wood Grey / Y = 34.2

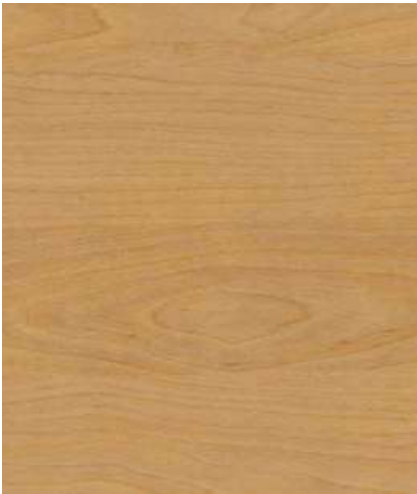

4331 - Wood Natural / Y = 29.9



2790 - Polished Concrete Dark Grey / Y = 15.3



8069 - Wood Chocolate / Y = 9.4

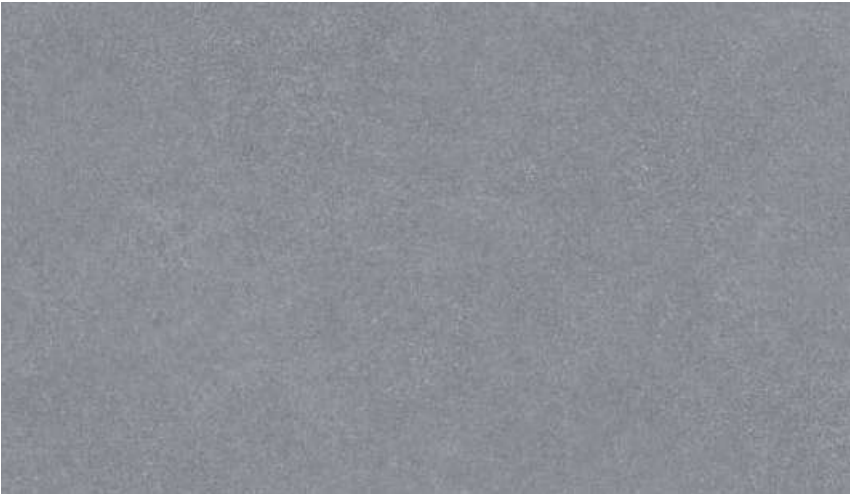

2791 - Polished Concrete Light Grey / Y = 27.4

## RACKET SPORTS

- ▶ **Racket sport floors** should offer an excellent compromise between slide and grip for lateral moves, accelerations and changes of direction.
- ▶ Gerflor offers a complete range of solutions for **racket sports** with different types of installation methods (portable and permanent floors) to meet player's expectations and facilities needs.

### TARAFLEX® TABLE TENNIS

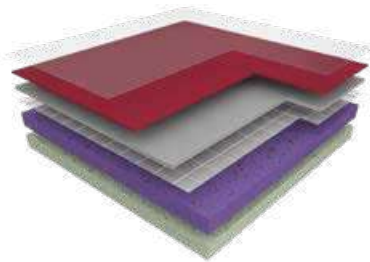

#### PERMANENT SOLUTION

THICKNESS  
 4.5 mm    6.2 mm    P1

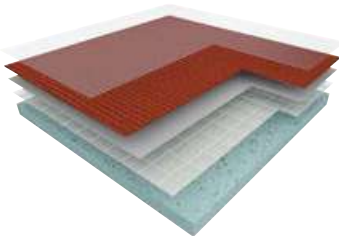

#### PORTABLE SOLUTION

THICKNESS  
 3.7 mm      

ENGINEERED AND DEVELOPED  
 IN PARTNERSHIP WITH  
 THE INTERNATIONAL TABLE  
 TENNIS FEDERATION (ITTF)



**PERMANENT SOLUTION**  
 6109  
 Framboise

**PORTABLE SOLUTION**  
 6109  
 Framboise

### TARAFLEX® BADMINTON

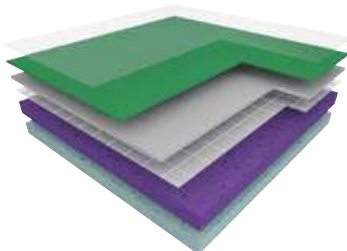

#### PERMANENT SOLUTION

THICKNESS  
 4.5 mm    7.5 mm    P1

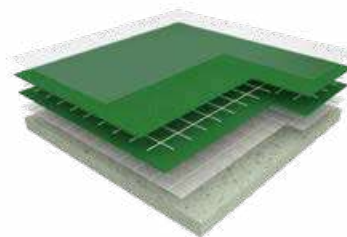

#### PORTABLE SOLUTION

THICKNESS  
 3.9 mm

THE ULTIMATE FLOOR FOR  
 BADMINTON MOVEMENTS



**PERMANENT SOLUTION**  
 6570  
 Mint Green

**PORTABLE SOLUTION**  
 6570  
 Mint Green

### TARAFLEX® TENNIS

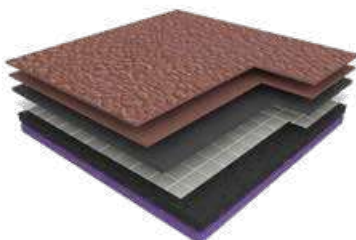

#### PERMANENT SOLUTION

THICKNESS  
 6.2 mm    P1



6504  
 London

6118  
 Paris

6471  
 Melbourne

6478  
 Purple

6473  
 New York

THE IDEAL AND SAFEST TENNIS  
 SURFACE FOR ALL PLAYERS

# APPLICATIONS

## DISABILITY AND ROLLING **SPORTS**

► Taraflex® Sports Floorings are recognised all over the world for all types of sports. Cushioned floors, with high IPI values offer the best solution for sitting sports.

### TARAFLEX® **MULTI-USE**

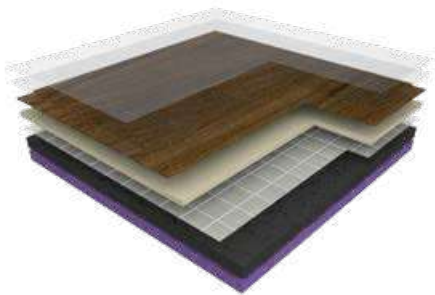



THICKNESS  
 6.2 mm P1

THE IDEAL COMBINATION BETWEEN SPORTS PERFORMANCE AND RESISTANCE TO ROLLING LOADS

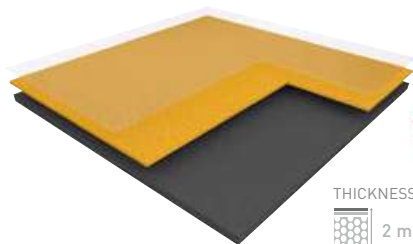

### TARAFLEX® **SURFACE**



THICKNESS  
 2 mm



### TARAFLEX® **COMFORT**

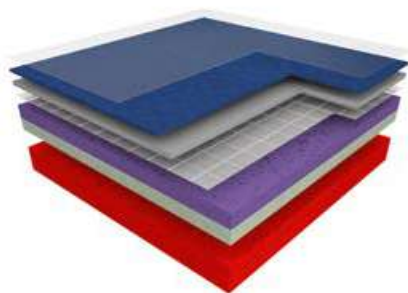



THICKNESS  
 12.5 mm P3

THE PERFECT SOLUTION FOR SAFETY AND PROTECTION





Description	Standard	Requirement	Units	Taraflex® Surface	Taraflex® Surface Mask	Taraflex® Multi-Use	Taraflex® Evolution	Taraflex® Performance	Taraflex® Comfort
Dry-Tex™ System	-	-	-	-	-	-			-
<b>Product Description</b>									
Surface treatment	-	-	-	Triple-Action Protecsol®	Triple-Action Protecsol®	Triple-Action Protecsol®	Triple-Action Protecsol®	Triple-Action Protecsol®	Triple-Action Protecsol®
Surface complex	-	-	-	D-Max™	100% PVC	D-Max™	D-Max™	D-Max™	D-Max™
Foam	-	-	-	-	-	CXP-HD +™	CXP-HD™	CXP-HD™	CXP-HD™
Thickness	EN ISO 24346	-	mm	2	2	6.2	7.5	9	12.5
Weight	EN ISO 23997	-	kg/m²	2.9	2.58	4.2	4.7	5.25	5.1
Length*	EN ISO 24341	-	lm	26.5 Max	20 Max	26.5 Max	26.5 Max	26.5 Max	26.5 Max
Width	EN ISO 24341	-	lm	1.5	2	1.5	1.5	1.5	-
<b>Sport Properties</b>									
Shock absorption	EN 14808	≥ 25	%	-	-	P1	P1	P2	P3
Impact Protection Index (IPI)	AC-P90-205	-	%	-	-	52	76	82	89
Vertical deformation	EN 14809	≤ 3.5	mm	≤ 2	≤ 2	≤ 2	≤ 2	≤ 3	≤ 3.5
Sliding coefficient	EN 13036-4	80 to 110	-	80 to 110	80 to 110	80 to 110	80 to 110	80 to 110	80 to 110
Ball bounce	EN 12235	≥ 90	%	≥ 90	≥ 90	≥ 90	≥ 90	≥ 90	≥ 90
Ball speed	ITF	-	-	-	-	-	-	-	-
<b>Technical Characteristics</b>									
Abrasion resistance	EN ISO 5470-1	≤ 1000	mg	≤ 350	≤ 350	≤ 350	≤ 350	≤ 350	≤ 350
Impact resistance	EN 1517	≥ 8	N/m	≥ 8	≥ 8	≥ 8	≥ 8	≥ 8	≥ 8
Indentation resistance	EN 1516	≤ 0.5	mm	≤ 0.5	≤ 0.5	≤ 0.5	≤ 0.5	≤ 0.5	≤ 0.5
Impact sound insulation	EN 712-2	-	dB	3	-	18	19	20	21
<b>Classification</b>									
Fire	EN 13501-1	-	-	B <sub>fl</sub> -s1	B <sub>fl</sub> -s1	C <sub>fl</sub> -s1	C <sub>fl</sub> -s1	C <sub>fl</sub> -s1	C <sub>fl</sub> -s1
Anti-bacterial activity (E. coli - S. aureus - MRSA) <sup>(1)</sup>	ISO 22196	-	-	> 99% inhibits growth					
Anti-viral activity (human coronavirus) after 2h <sup>(1)</sup>	ISO 21702	-	-	> 99.3% virucidal activity					
<b>CE Marking</b>									
	EN 14 904	-	-	Fire Sliding Coefficient Abrasion Resistance Rolling load Resistance	Fire Shock Absorption Sliding Coefficient Abrasion Resistance Rolling load Resistance				

The proposed specifications fall within the tolerance limits usually accepted in this sector whilst still complying with standards.

<sup>(1)</sup> The implementation of an effective cleaning method is the best defence against infection

\* For different roll lengths please contact us

## INSTALLATION ON DAMP SUBFLOOR

Gerflor provides installation on Isolsport (free floating underlay) or Taraflex® Dry-Tex™ System. Please contact your sales representative for more information.

# TO KNOW

Taraflex® Tennis	Taraflex® Badminton			Taraflex® Table Tennis			Taraflex® Bateco	Taraflex® Isolsport
	Portable	4.5	7.5	Portable	4.5	6.2		
-	-	-		-	-	-	-	-
-	Triple-Action Protecsol®	PUR Protect®	Triple-Action Protecsol®	Triple-Action Protecsol®	PUR Protect®	Triple-Action Protecsol®	-	-
D-Max™	100% Pur PVC	100% Pur PVC	D-Max™	100% Pur PVC	100% Pur PVC	D-Max™	-	-
CXP-HD+™	-	-	CXP-HD™	-	-	CXP-HD+™	-	-
6.2	3.9	4.5	7.5	3.7	4.5	6.2	1.5	1.65
3.8	1.95	2.6	4.7	1.9	2.6	4.2	2.05	1.35
24 STD	16 STD	20.5 STD	26.5 Max	16 STD	20.5 STD	20.5 STD	30 Max	45 Max
1.5	3 x 2.7	1.5	1.5	1.5	1.5	1.5	1.5	2
P1	-	-	P1	-	-	P1	-	-
52	-	-	76	-	-	52	-	-
≤ 2	≤ 2	≤ 2	≤ 2	≤ 2	≤ 2	≤ 2	-	-
80 to 110	80 to 110	80 to 110	80 to 110	80 to 110	80 to 110	80 to 110	-	-
≥ 90	-	≥ 90	-	-	≥ 90	≥ 90	-	-
Class 5 (Fast)	-	-	-	-	-	-	-	-
≤ 350	≤ 350	≤ 350	≤ 350	≤ 350	≤ 350	≤ 350	≤ 300	-
≥ 8	-	-	≥ 8	-	-	≥ 8	-	-
≤ 0.5	≤ 0.5	≤ 0.5	≤ 0.5	≤ 0.5	≤ 0.5	≤ 0.5	≤ 0.5	≤ 0.5
18	-	17	19	-	17	18	-	-
C <sub>fl</sub> -s1	B <sub>fl</sub> -s1	C <sub>fl</sub> -s1	C <sub>fl</sub> -s1	B <sub>fl</sub> -s1	C <sub>fl</sub> -s1	C <sub>fl</sub> -s1	B <sub>fl</sub> -s1	C <sub>fl</sub> -s1
> 99% inhibits growth		-	> 99% inhibits growth		-	> 99% inhibits growth	-	-
-	> 99.3% virucidal activity	-	> 99.3% virucidal activity		-	> 99.3% virucidal activity	-	-
Fire Shock Absorption Sliding Coefficient Abrasion Resistance Rolling load Resistance	Fire	Fire Sliding Coefficient Abrasion Resistance Rolling load Resistance	Fire Shock Absorption Sliding Coefficient Abrasion Resistance Rolling load Resistance	Fire Sliding Coefficient Abrasion Resistance	Fire Sliding Coefficient Abrasion Resistance Rolling load Resistance	Fire Shock Absorption Sliding Coefficient Abrasion Resistance Rolling load Resistance	Fire	Fire

## WHAT WILL YOURS BE?

### MY TARAFLEX®

CUSTOMISE YOUR SPORT HALL USING THE DIGITAL PRINTING PROCESS

AVAILABLE WITH ALL TARAFLEX® FLOORS\*: TARAFLEX® SURFACE, TARAFLEX® PERFORMANCE, TARAFLEX® EVOLUTION, TARAFLEX® COMFORT, TARAFLEX® MULTI-USE

\* for more details please contact your local Gerflor representative

Get started on our website: [mytaraflex.gerflor.com](http://mytaraflex.gerflor.com)

### BE INSPIRED...



Golden Herringbone



Wood Crosscut



Pure Concrete

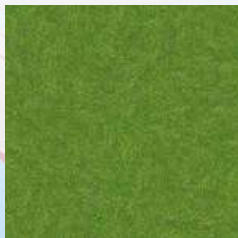

Spring Grass



Blue Wave





# TO MAKE YOUR FLOOR UNIQUE

## 3D COURT DESIGNER

FOR A 3D VISUALISATION OF YOUR PROJECT



1

Choose your surface:  
monosport or multisports



2

Choose your colours



3

Visualise  
your sport hall

Available on: [courtdesigner.gerflor.com](http://courtdesigner.gerflor.com)

## MY LOGOS

FOR A STUNNING RESULT



Thanks to the waterjet cutting technology,  
**customise your floor** with your city or club colours.

For further information, please contact your local Gerflor representative.

## INTERIOR DESIGNER

FOR A REALISTIC VIEW OF YOUR ENVIRONMENT

- ▶ Download your picture and include the floor
- ▶ Or change the floor colours in selected pictures

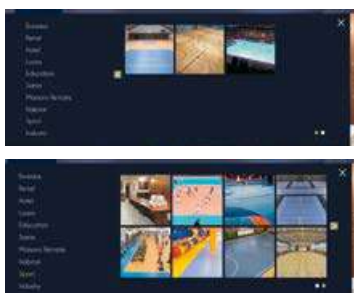

Available on: [interiordesigner.gerflor.com](http://interiordesigner.gerflor.com)



**CONNOR  
SPORTS**

HARDWOOD FLOORING SYSTEMS



# WHERE CHAMPIONS PLAY™

## TOP COMPETITIONS TAKE PLACE ON CONNOR SPORTS®

### BASKETBALL

- ▶ 2020 Olympic Games (Tokyo)
- ▶ 2019 FIBA World Cup (China)
- ▶ 2016 Olympic Games (Rio)
- ▶ NCAA Final Four since 2006 (USA)



## CHAMPIONS DESERVE EXCEPTIONAL SPORT SURFACE

### SO WE SELECT EXCEPTIONAL MAPLE LUMBER FOR THEM

Connor Sports® hand selects north american maple trees grown north of the 35<sup>th</sup> parallel, where the shorter growing season produces a more dense and uniform woodgrain excellent for sports flooring.



Since its establishment in 1897, the Maple Flooring Manufacturers Association (MFMA) is the authoritative source of technical and general information about maple flooring and related sports flooring systems. Connor Sports® is a charter member of the MFMA and the 1<sup>st</sup> member of that group to be certified by the Rainforest Alliance.



Connor Sports® is proud to be the only ZeroWaste company in the sports flooring industry. Recycling, avoiding waste, developing innovative technology and a strong environmental consciousness are a major part of Connor Sports® corporate policy.



Connor Sports® works with FSC (Forest Stewardship Council®). This organization oversees high conservation value forest and protects the communities and indigenous people that rely on the forest. FSC ensures that everyone delivers the most environmentally friendly product.

## CHAMPIONS OF SPORT

### HARDWOOD SYSTEMS FOR PROFESSIONAL TEAMS

More than half of the teams in the NBA have purchased a Connor Sports® hardwood system:



Boston Celtics



Brooklyn Nets



Philadelphia 76ers



Oklahoma City Thunder



Atlanta Hawks



Golden State Warriors



Sacramento Kings



Utah Jazz



Milwaukee Bucks





SPORT  
COURT

OUTDOOR SURFACES

## GERFLOR, WHERE CHAMPIONS PLAY™

### SHARING MORE THAN SPORT!

BRING PEOPLE TOGETHER FOR UNFORGETTABLE MOMENTS  
AND LIFETIME MEMORIES

With our modular PowerGame+ tiles, we offer everyone the opportunity to share such memorable sport and recreational experiences.

Our premium surfaces are not only fun, great-looking and safe to play on, but they can also be easily installed in all facilities. You can be sure you're providing the ideal playing outdoor surface for every practice and ambitions, from children to champions.



# DESIGNED FOR MULTI-SPORTS

Sport Court® surfaces are designed for a wide variety of sports. All game courts can be easily configured to accommodate basketball, futsal, handball, tennis and more, without compromising on playability or safety.

A number of temporary or permanent applications are possible, from multi-sport school facilities to multi-use game areas to all kinds of sporting events.



## SPORT COURT® OUTDOOR SURFACES

**266-271**

- Gerflor, where champions play 266
- Designed for multi-sports 267
- They trust us 268
- Long-lasting aesthetics 268
- Optimal playability and safety 269
- Save time and money 270
- Powergame+ product benefits 271
- A greater court with finishing profiles 271



# THEY TRUST US

## PARTNER OF SPORTS FEDERATIONS

Sport Court® surfaces are used at the highest levels of competition by leading sports federations around the world. Our courts are perfect for both temporary events and permanent installations.

**100 000**  
courts installed since 1974



## LONG-LASTING AESTHETICS

Design a court that makes an impression. With a selection of 10 fade-resistant tile colours, you have more ways to customise the look of your playing surfaces to fit your requirements, whether you want a fun colourful court, or to customise it with your company's or school's colours.

### CHOOSE YOUR COLOURS

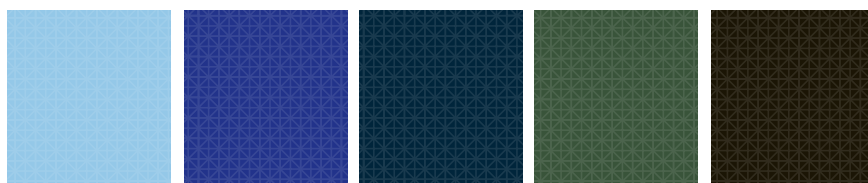

STEEL BLUE

BRIGHT BLUE

DARK BLUE

GREEN

BLACK

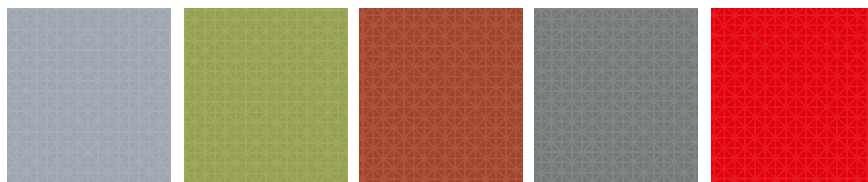

GRAY

KIWI

TERRACOTTA

GRANITE

BRIGHT RED



Customise your court by easily adding logos and game lines, and make it uniquely yours!



# OPTIMAL PLAYABILITY AND SAFETY

Powergame+ tiles provide exceptional protection against abrasion, head injuries and joint strain. Extensive third-party testing ensures that athletes of any age remain safe while playing and competing on Sport Court® surfaces.

## ACCOMMODATE MANY SPORTS WITH UNMATCHED PLAYABILITY AND SAFETY



### POWERGAME+ ENHANCES GAME EXPERIENCE

- Highly versatile multisport surface
- Same dribbling response as a hardwood flooring
- Remarkably stable surface

### POWERGAME+ PROVIDES A UNIQUE BALANCE BETWEEN SAFETY, COMFORT AND DURABILITY

- High tile stability optimises ball rebound and game performance
- Improved water drainage enables faster drying and playability after rain
- Low skin abrasion protects players when falling without compromising on traction

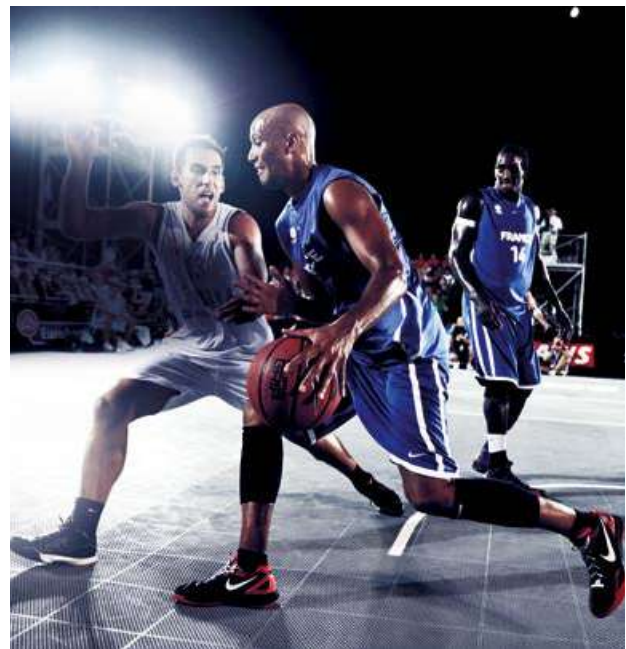

### SUPERIOR IMPACT PROTECTION

A head impact from just 10 cm above a concrete surface can cause a concussion. Sport Court® tiles are significantly more forgiving, with PowerGame+ reducing the likelihood of a serious head injury from a fall of 50 cm

Critical Fall Height is a test used in conjunction with the European Standards EN 1177-2018, used for evaluating playground surfaces, such as sand, wood chips, resilient rubber and asphalt.

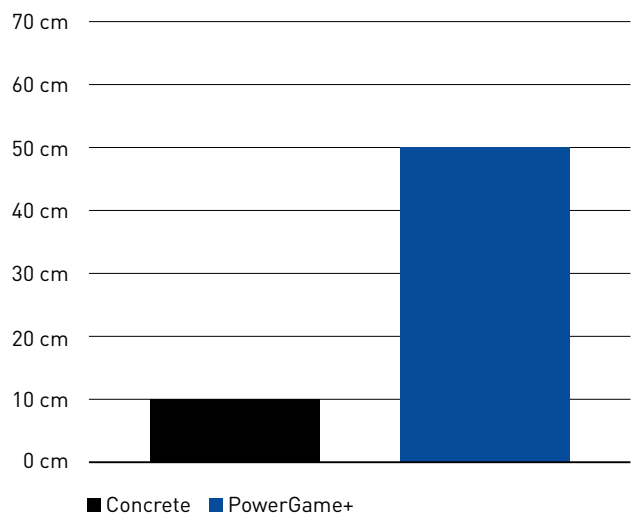

# SAVE TIME AND MONEY

## EASY INSTALLATION AND MAINTENANCE

THE SIMPLE AND STRONG INTERLOCKING SYSTEM ENABLES THE INSTALLATION OF A 1,000 SQM COURT IN 4H



**1,000M<sup>2</sup> COURT = 4H COURT INSTALLATION + 2H GAME LINE PAINTING**

WITH A 4-PERSON TEAM





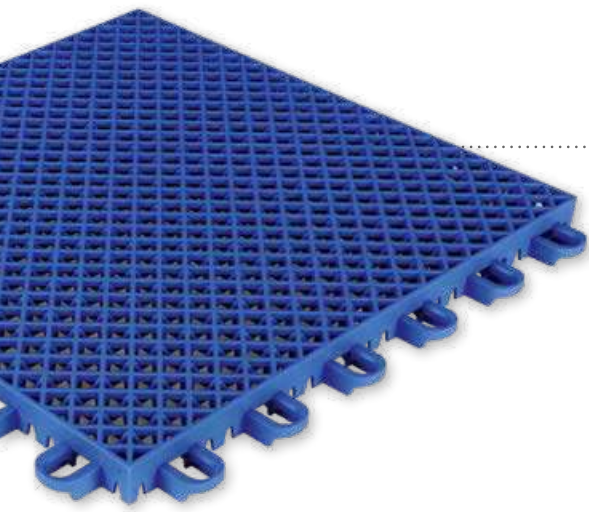

## THE NEXT STEP IN MULTI-SPORTS OUTDOOR SURFACING

Designed to provide the highest levels of safety and playability. PowerGame+ is the perfect choice for your facility.



MADE IN FRANCE

### LONG-LASTING AESTHETICS



**UV PROTECTION**

OUTSTANDING COLOUR DURABILITY

### EXTREME DURABILITY



**WIDE AND DEEP CONNECTION LOOPS**

HIGH STABILITY AND DURABILITY OVER INSTALLATION AND REMOVAL, SAFETY OF THE PLAYERS

### OPTIMAL PLAYABILITY

#### OPTIMAL GRID DESIGN

DOUBLE-GRID STRUCTURE FOR FASTER DRYING, REDUCED WATER REBOUND, AND OPTIMAL SAFETY

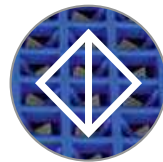

TOP-GRID: "OPEN DIAMOND" DESIGN FOR BETTER DRAINAGE

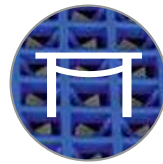

LOWER GRID: "SADDLE" SHAPE TO PREVENT WATER RETENTION

## A GREATER COURT WITH FINISHING PROFILES

Discover our complete range of finishing profiles, adapted to every court configuration.

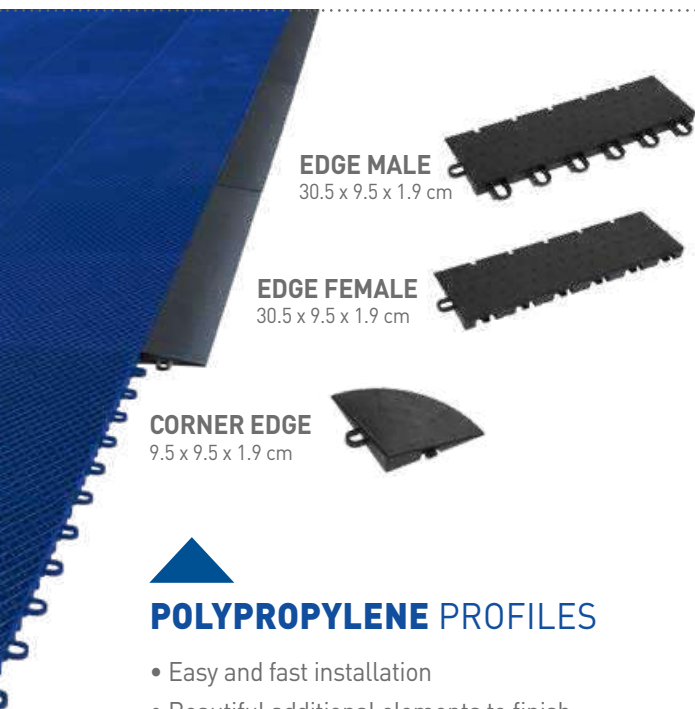

**EDGE MALE**

30.5 x 9.5 x 1.9 cm

**EDGE FEMALE**

30.5 x 9.5 x 1.9 cm

**CORNER EDGE**

9.5 x 9.5 x 1.9 cm

### POLYPROPYLENE PROFILES

- Easy and fast installation
- Beautiful additional elements to finish the court

#### CORNER OF RAMP EDGES

Finishing angle to be associated with ramp edges. 148 x 18.2 x 2 cm

#### RAMP EDGE

Finishing solution for courts installed over a flat support. 148 x 18.2 x 2 cm

#### FLAT THRESHOLD

Finishing solution for courts integrated into a support to have a flat transition. 148 x 15 x 0.3 cm

#### SKIRTING

Finishing solution for courts surrounded by an infrastructure (wall, gates...). 148 x 10 x 10 cm

### METAL PROFILES

- Resistance to harsh weather conditions and to vandalism thanks to the anchored installation
- Beautiful additional elements to finish the court, in every possible configuration







INDOOR PLAY AREAS





**DLW**  
LINOLEUM SPORTS FLOORINGS  
**272-277**

- Linodur Sport 276
- Colorette Sport 276
- Marmorette Sport 277
- Linogym II System 277

# LINOLEUM SPORT

## COLORETTE SPORT / LINODUR SPORT / MARMORETTE SPORT

### ▶ COLORETTE SPORT

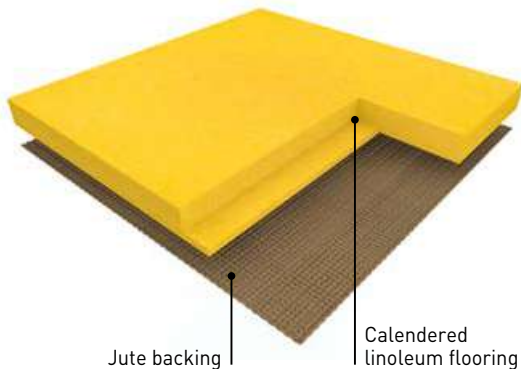

**COLORETTE SPORT** is a calendered linoleum compact floorcovering in sheet, 2 m wide, compatible with Gymflex II rubber underlay for a point elastic installation. Its weight is 4700 gr/sqm in 4.0 mm. It features a speckled design. It is composed of 98% natural materials (linseed oil, wood flour, resins, cork, minerals and jute fabric) among which 76% are rapidly renewable. The flooring is 100% recyclable, is composed of minimum 25% recycled content and up to 40% recycled content, 100% controlled, is REACH compliant and rated Cfl-s1 for fire resistance. The product also benefits from international certifications such as Floorscore® and Blue Angel (emissions). Designed and manufactured in a sustainable way in a plant awarded with ISO 9001 (quality), ISO 14001 (environment) and ISO 50001 (energy) certifications, the flooring is certified "Cradle to Cradle Silver". Its Environmental Performance Declaration (EPD) certified by an external laboratory, indicates carbon neutrality during the first stages of its life cycle ("from cradle to gate").

### ▶ LINODUR SPORT

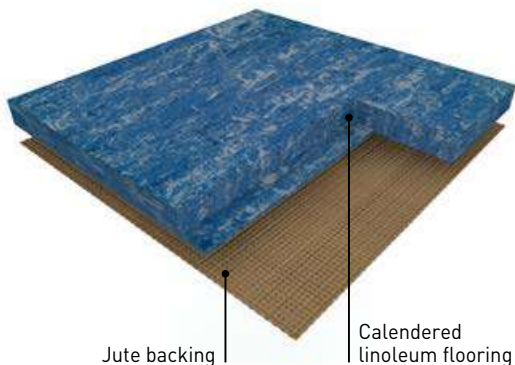

**LINODUR SPORT** is a calendered linoleum compact floorcovering in sheet, 2 m wide, compatible with Gymflex II rubber underlay for a point elastic installation. Its weight is 4700 gr/sqm in 4.0 mm. It features a moiré design. It is composed of 98% natural materials (linseed oil, wood flour, resins, cork, minerals and jute fabric) among which 76% are rapidly renewable. The flooring is 100% recyclable, is composed of minimum 25% recycled content and up to 40% recycled content, 100% controlled, is REACH compliant and rated Cfl-s1 for fire resistance. The product also benefits from international certifications such as Floorscore® and Blue Angel (emissions). Designed and manufactured in a sustainable way in a plant awarded with ISO 9001 (quality), ISO 14001 (environment) and ISO 50001 (energy) certifications, the flooring is certified "Cradle to Cradle Silver". Its Environmental Performance Declaration (EPD) certified by an external laboratory, indicates carbon neutrality during the first stages of its life cycle ("from cradle to gate").

### ▶ MARMORETTE SPORT

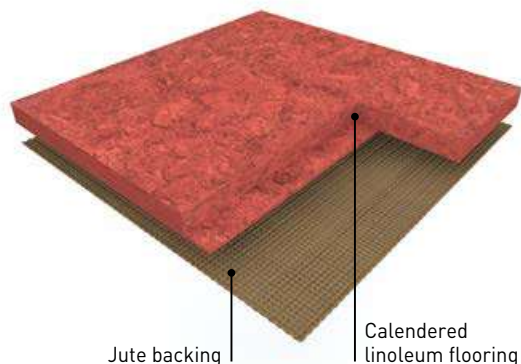





**MARMORETTE SPORT** is a calendered linoleum compact floorcovering in sheet, 2 m wide. Its weight is 3800 gr/sqm in 3.2 mm. It features a marbled design. It is composed of 98% natural materials (linseed oil, wood flour, resins, cork, minerals and jute fabric) among which 76% are rapidly renewable. The flooring is 100% recyclable, is composed of minimum 25% recycled content and up to 40% recycled content, 100% controlled, is REACH compliant and rated Cfl-s1 for fire resistance. The product also benefits from international certifications such as Floorscore® and Blue Angel (emissions). Designed and manufactured in a sustainable way in a plant awarded with ISO 9001 (quality), ISO 14001 (environment) and ISO 50001 (energy) certifications, the flooring is certified "Cradle to Cradle Silver". Its Environmental Performance Declaration (EPD) certified by an external laboratory, indicates carbon neutrality during the first stages of its life cycle ("from cradle to gate").



# COLORETTE SPORT / LINODUR SPORT / MARMORETTE SPORT

4.0 mm

3.2 mm

			COLORETTE SPORT	LINODUR SPORT	MARMORETTE SPORT
<b>DESCRIPTION</b>					
Total thickness	EN ISO 24346	mm	4.0	4.0	3.2
Backing	-	-	Jute fabric	Jute fabric	Jute fabric
Weight	EN ISO 23997	g/sqm	4700	4700	3800
Width of sheet	EN ISO 24341	cm	200	200	200
Length of sheet	EN ISO 24341	m	app. 28	app. 28	app. 28
<b>CLASSIFICATION</b>					
Norm / Product specification	-	-	EN 14904 / DIN 18032-2	EN 14904 / DIN 18032-2	EN 14904 / DIN 18032-2
European classification	EN ISO 10874	class	23 / 34 / 43	23 / 34 / 43	23 / 34 / 43
Fire rating	EN 13501-1	class	Cfl-s1 <sup>(1)</sup>	Cfl-s1 <sup>(1)</sup>	Cfl-s1 <sup>(1)</sup>
Dynamic friction coefficient	DIN 18032-2	-	0.4 - 0.6 $\mu$ - Fulfilled	0.4 - 0.6 $\mu$ - Fulfilled	0.4 - 0.6 $\mu$ - Fulfilled
Friction	EN 14904	-	80-110 - Fulfilled	80-110 - Fulfilled	80-110 - Fulfilled
Impact sound insulation	EN ISO 717-2	dB	6 dB	6 dB	6 dB
<b>PERFORMANCES</b>					
Residual indentation	EN ISO 24343-1	mm	$\leq 0.20$	$\leq 0.20$	$\leq 0.15$
Colour fastness	EN ISO 105 - B02	degree	6	6	6
Light reflexion	DIN 5036-3	-	p $\geq 0.20$ fulfilled (excepted colours 0004 and 0080)	p $\geq 0.20$ fulfilled (excepted colours 0024 and 0081)	p $\geq 0.20$ fulfilled
Static electrical propensity	EN 1815	kV	app. 2.0	app. 2.0	app. 2.0
Castor chair test (Type W)	ISO 4918	-	OK	OK	OK
Thermal resistance	EN 12667	sqm,K/W	0.023	0.023	0.018
Thermal conductivity	EN ISO 10456	W/(m.K)	0.17	0.17	0.17
Chemical products resistance	EN ISO 26987	class	Resistance to fat and mineral oil and short term resistance against diluted acids		
<b>CE MARKING</b>					
CE	EN 14904: 2006	-			
		-			

<sup>(1)</sup> Glued according to certificate.  
DOP numbers available from your local branch.

 Depending on light exposure, the product color can vary, due to linoleum natural oxidization process. This process is reversible.  
We recommend that the samples be exposed to sunlight for several hours prior to making a final color choice.

# LINOLEUM SPORT

## LINODUR SPORT



4.0 mm



1048 Country Beige



1074 Straw Yellow

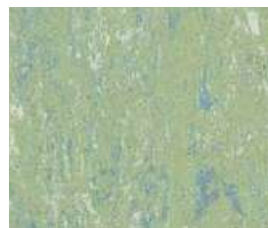

1036 Smooth Green



1049 Cliff Grey



1072 Peach Orange



1011 Avocado Green



1056 Marble Grey



1059 Slate Grey



1073 Glowing Rock



1026 Lagoon



1057 Heaven Blue



1081 Sporty Black



1013 Lava Red



1024 Speckled Blue



1020 Spring Blue

## COLORETTE SPORT



4.0 mm



1080 Elephant Grey



1059 Stone Grey



1012 Light Beige



1004 Bluebird



1118 Power Red



1171 Sunrise Orange



1001 Banana Yellow



1132 Lime Green

# MARMORETTE SPORT



3.2 mm



1076 Pale Yellow



1070 Rocky Brown



1172 Papaya Orange

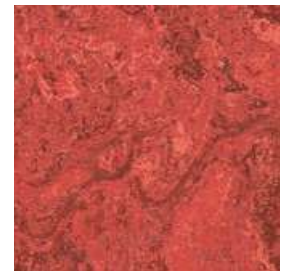

1048 Cranberry Red



1053 Ice Grey



1050 Quartz Grey



1132 Lime Green



1026 Sky Blue

## LINOGYM II - 10 mm

Ideally suited for kindergardens. With a 26% impact absorption rate, **LINOGYM II SYSTEM** provides outstanding cushioning qualities.

**THE LINOGYM II SYSTEM** – point-elastic flooring!

**LINOGYM II SYSTEM** brings together the best of Sport Linoleum and elastic matting. It consists of the 6 mm elastic matting Gymflex II on which a 4 mm Sports Linoleum (Linodur or Colorette) will be installed. With a 26% impact absorption rate, **LINOGYM II SYSTEM** provides outstanding cushioning qualities. The elastic matting is made of PUR foam, rubber powder and binder.

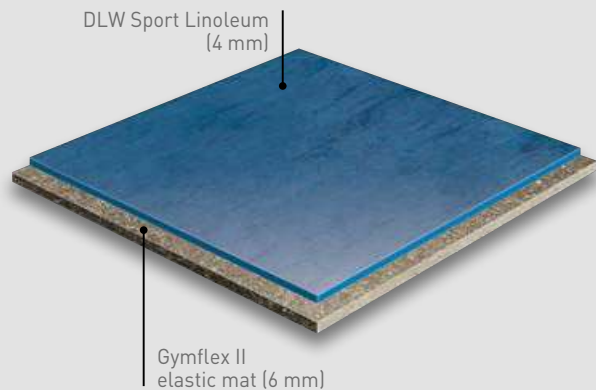



PLEASE RE-RACK YOUR  
WEIGHTS AFTER USE

PLEASE RE-RACK YOUR  
WEIGHTS AFTER USE

**POWERSHOCK**  
RUBBER SOLUTIONS FOR FITNESS



# HIGH IMPACT RUBBER SOLUTIONS FOR FITNESS

## POWERSHOCK 80

### CARDIO & FREE-WEIGHT ZONE

8 MM  
INTERLOCKING TILES  
WITH DOVETAIL EDGES



#### POWERSHOCK 80 is:

- ✓ Highly  **durable**
- ✓ Easy to  **clean and maintain**
- ✓  **Highly resistant** to static loads and to dumbbells thanks to the vulcanization process of this 8 mm vulcanized rubber.

Vulcanized rubber is a chemical process through high pressure and temperature enables the sulfur atoms to form links and bridges between long chains of rubber molecules. This increases the overall  **strength and durability of the rubber.**

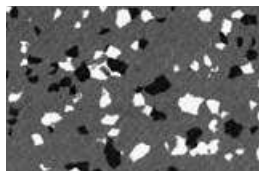
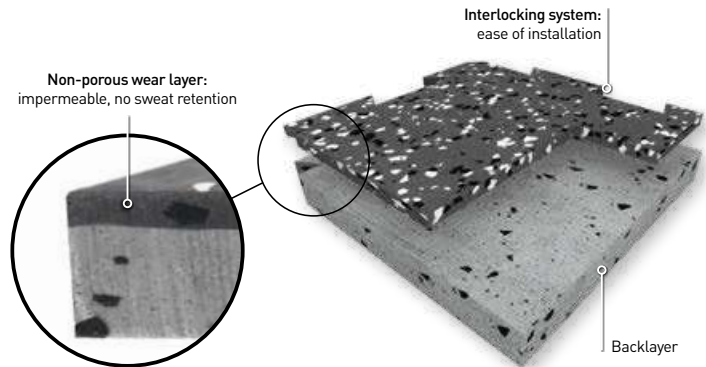

DARK GREY



BLACK

#### ACCESSORIES ..... (available from Romus)



Aluminium reducer  
Unit: 3 lm



Multilevel coverstrip  
Unit: 2.7 lm

## POWERSHOCK 300

### CROSSFIT & HEAVY-WEIGHT AREA

30 MM  
TILES WITH PRE-INSTALLED  
CONNECTOR PINS



#### POWERSHOCK 300

*avoids deep-impact damage while providing an outstanding sound deadening, as well as:*

- ✓ high  **shock absorption**
- ✓  **sound insulation** of 24 dB
- ✓ great  **protection of the subfloor** being a 30 mm high impact rubber.

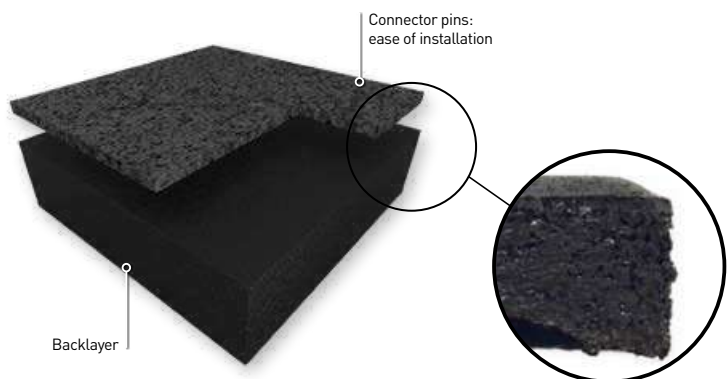

DARK GREY

#### ACCESSORIES ..... (available from Romus)

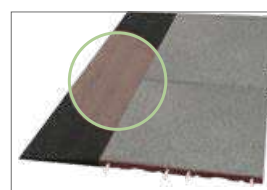

Ramp edge rubber  
30 mm  
1 lm



Corner ramp edge rubber  
30 mm  
2 units (1000 x 250 mm)

# TECHNICAL DATA

POWERSHOCK	
80	300
CARDIO & FREE-WEIGHT AREA	CROSSFIT & HEAVY-WEIGHT AREA

## DESCRIPTION

Thickness	NF EN ISO 24346	mm	8	30 (± 2)
Weight	NF EN ISO 23997	kg/tile	11.9	6.8 (± 0.2)
Size	NF EN ISO 24342	mm	980 x 980 (incl. dovetails)	500 x 500 (± 0.8%)

## CLASSIFICATION

Fire resistance	EN 13501-1	class	B <sub>fl,s1</sub>	C <sub>fl,s1</sub>
VOC	ISO 16000-6	class	A+	A+

## PERFORMANCE

Dimensional stability	NF EN ISO 23999	%	< 0.3	< 0.1
Abrasion	EN ISO 5470-1	g	< 0.5	1.5
Light resistance	EN ISO 20105 - B02	level	4	3
Indentation resistance	EN 1516	mm	< 0.1	0.12
Slip resistance in dry condition	EN 13036-4	unit	80-110	80-110
Sound insulation	EN ISO 717/2	dB	13	24
Hardness shore A	Int.	-	> 75	60

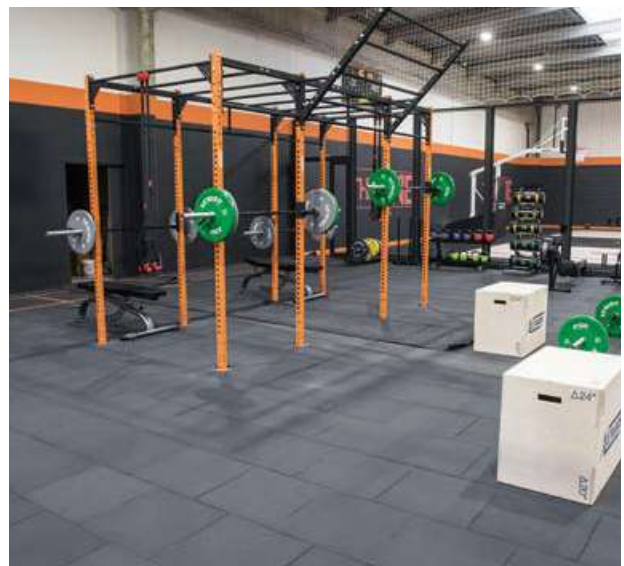



# OUR SOLUTIONS FOR YOUR FITNESS CENTER

Each zone in your club has different constraints and requirements; we have solutions for each one of them.

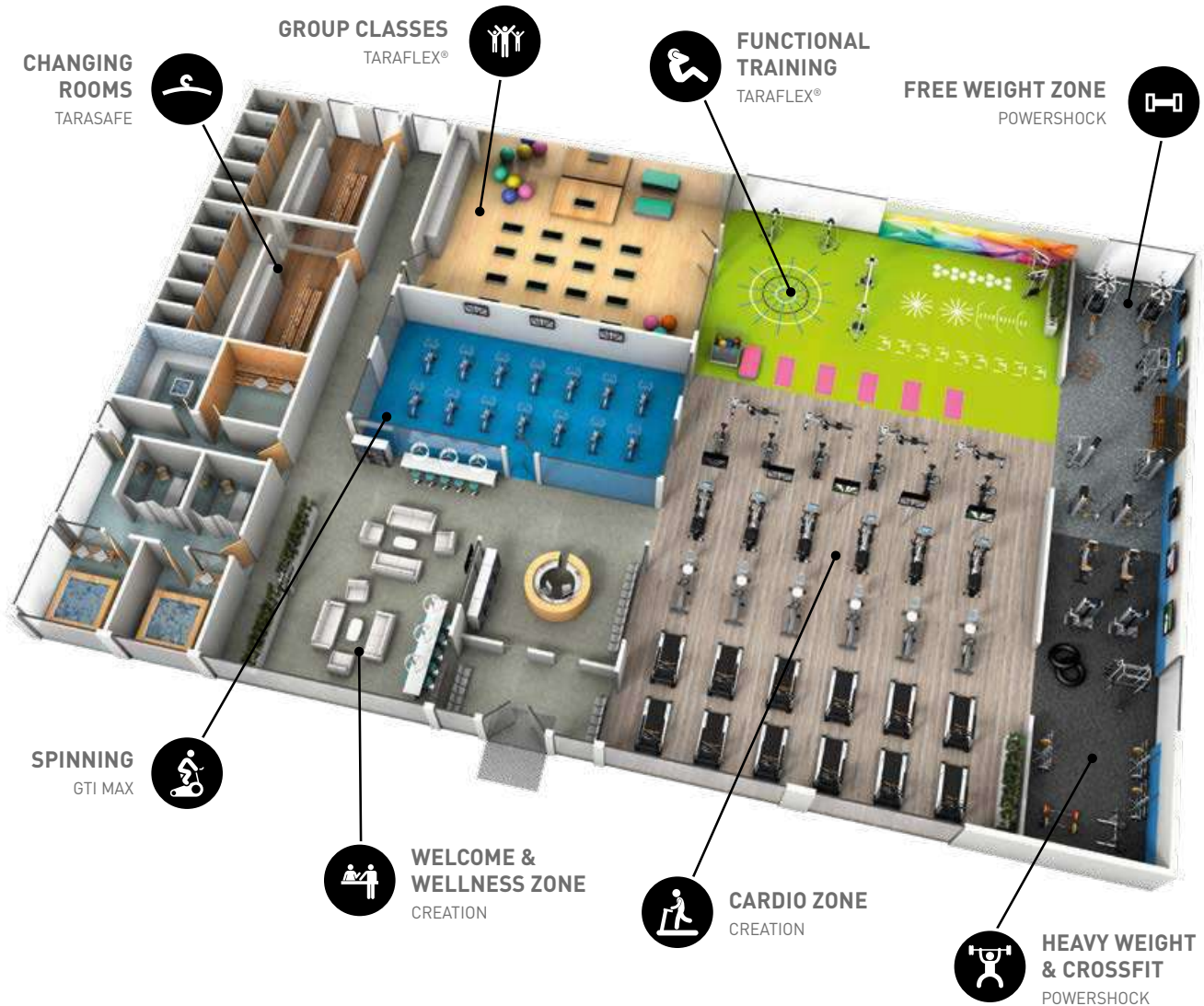

WELCOME ZONE



FUNCTIONAL TRAINING



SPINNING ZONE



CARDIO ZONE



GROUP CLASSES



WEIGHTLIFTING ZONE

Sports  
Floorings

A modern office interior featuring a staircase on the left with a metal handrail, a reception desk on the right, and a wall with a colorful, abstract mural. A large grey overlay is centered on the page, containing the text 'FINISHES' and '282/313'.

.....

# FINISHES

..... PAGES .....

# 282/313

.....





**Finishes .....284-297**

**Technical Solutions.....298-307**

**Sports Finishes.....308-313**



# FINISHES

<b>Skirting solutions</b> .....	<b>285-289</b>
<b>Stair solutions</b> .....	<b>290-291</b>
<b>Profile solutions</b> .....	<b>292-294</b>
<b>Welding solutions</b> .....	<b>295</b>
<b>Entrance solutions</b> .....	<b>296-297</b>

Gerflor provides a complete range of solutions including skirting, stairs, profiles and welds.



# FINISHES

## SKIRTING AND COVING SOLUTIONS

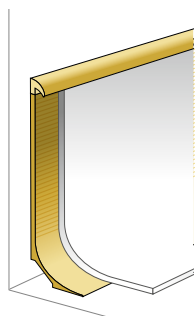

Flexible full cove former

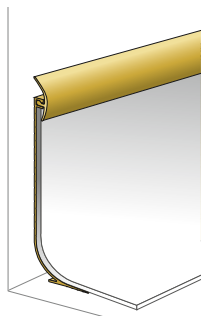

Full cove former Clip system

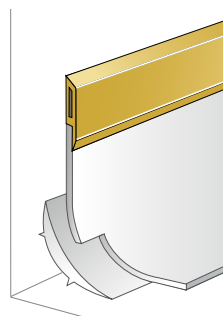

Capping strip

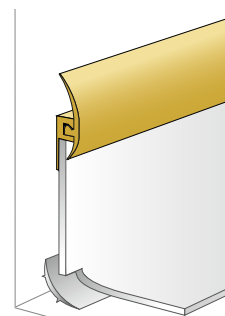

Capping strip - Clip system

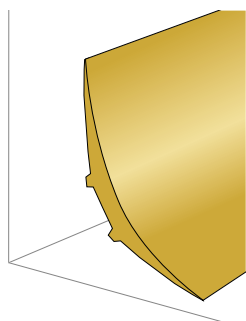

PVC Cove former

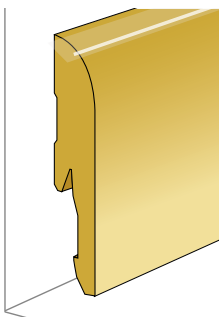

Design skirting (MDF)

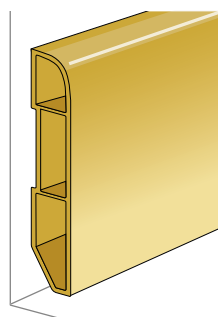

Design skirting (PVC)

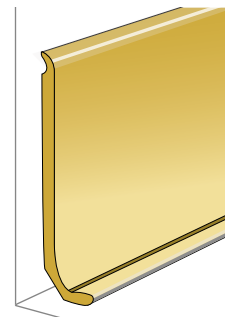

Semi-rigid skirting

**There are two ways of finishing the junction between the floor and wall:**

**1**

Installing the PVC covering up to the edge of the wall and using a skirting insert.  
This is cost effective and time saving.

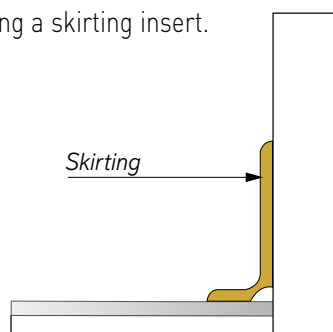
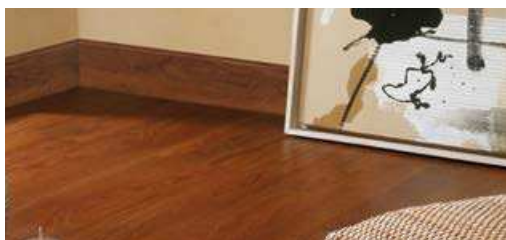

**2**



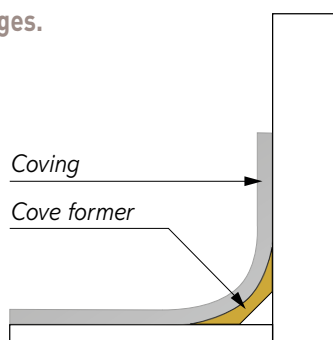

Making a cove.  
This solution makes it easier to clean inside angles and edges.  
It gives a waterproof connection wall/floor covering.

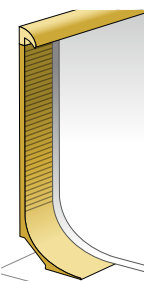

# FINISHES

## COVING SOLUTIONS

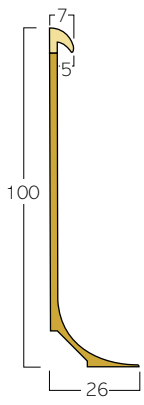
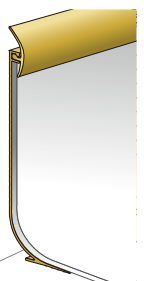
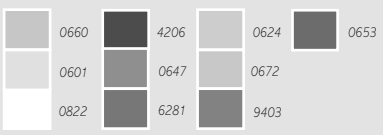
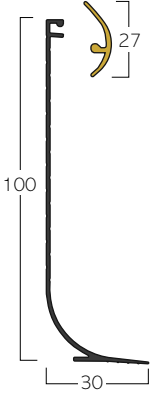
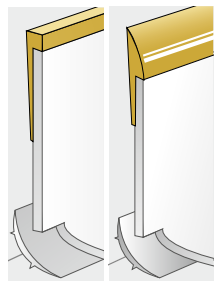
### PVC Capping strips

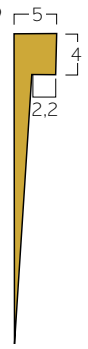
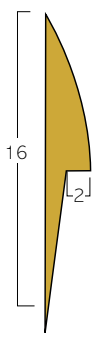
Description	Colours	Benefits	Tips
 <p><b>0488</b></p> <p><b>FLEXIBLE FULL COVE FORMER</b></p> <p><b>PVC profile combining the cover former and the capping strip into a single product.</b></p> <ul style="list-style-type: none"> <li>▶ Adapted to the hospital sector and any room requiring a waterproof skirting.</li> </ul>		<ul style="list-style-type: none"> <li>▶ Maximum floor covering thickness <b>4 mm</b></li> <li>▶ Guarantees <b>watertightness</b></li> <li>▶ <b>Quick to install</b></li> </ul>  <p><b>Packaging</b> 15 x 3 lm strips</p>	<ul style="list-style-type: none"> <li>● Heat the skirting with a heat gun in order to match the shape of the wall</li> <li>● Use either a double bonding adhesive, a dispersion contact adhesive or a double sided tape compatible with the PVC skirting</li> </ul>
 <p><b>0487</b></p> <p><b>FULL COVE FORMER CLIP-SYSTEM</b></p> <p><b>PVC profile combining the cover former and the capping strip into a single product.</b></p> <ul style="list-style-type: none"> <li>▶ Adapted to the hospital sector and any room requiring a waterproof skirting.</li> </ul>		<ul style="list-style-type: none"> <li>▶ Maximum floor covering thickness <b>4 mm</b></li> <li>▶ Guarantees <b>watertightness</b></li> <li>▶ <b>Quick &amp; easy to install thanks to the capping strips with clip</b></li> </ul>  <p><b>Packaging</b> 20 x 3 lm strips</p>	<ul style="list-style-type: none"> <li>● Heat the skirting with a heat gun in order to match the shape of the wall</li> <li>● Use either a double bonding adhesive, a dispersion contact adhesive or a double sided tape compatible with the PVC skirting</li> </ul>
 <p><b>P1509 / P769</b></p> <p><b>Finishes that can be welded to the floor covering</b></p> <ul style="list-style-type: none"> <li>▶ Do not use in commercial kitchens and showers</li> </ul>		<ul style="list-style-type: none"> <li>▶ P769: Adapted to 2 mm floors</li> <li>▶ P1509: Adapted to 2.2 mm floors</li> </ul>   <p><b>P1509</b> 0496</p> <p><b>Packaging</b> 30 x 3 lm strips</p> <p><b>P769</b> 0493</p> <p><b>Packaging</b> 2 rolls of 25 lm</p>	<ul style="list-style-type: none"> <li>● May also be used as a floor stopping profile</li> <li>● Weld with SG916</li> <li>● Use either a double bonding adhesive, a dispersion contact adhesive or a two-side adhesive compatible with the PVC skirting</li> </ul>



# COVING SOLUTIONS

## PVC Capping strips

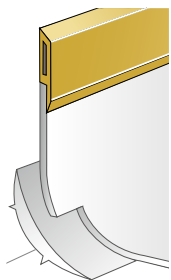

### CAPPING STRIPS

#### Rigid capping strip with flexible lip

- ▶ Do not use in commercial kitchens and showers

0491

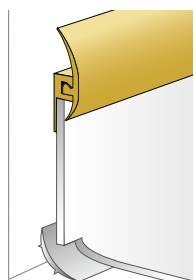

### CAPPING STRIP CLIP SYSTEM

#### Rigid clipped finishing profile with 2 flexible lips

- ▶ Capping strip that covers the skirting

0486

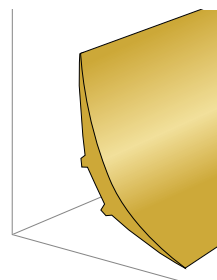

### PVC COVE FORMER

This accessory allows the floor-wall cove to be formed

4011 - 4012 - 4014

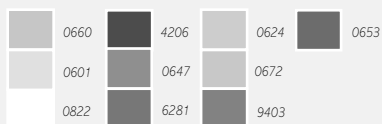
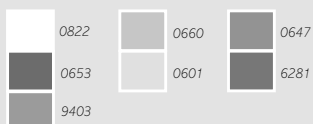

- ▶ Maximum covering thickness: 4 mm
- ▶ **Hygienic**
- ▶ **Easy to install**

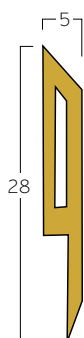

**Packaging**  
25 x 3 lm strips

- Slightly heat the strip if it whitens once installed
- Use a miter shear for a perfect cut
- Use either a double bonding adhesive, a dispersion contact adhesive or a double sided tape compatible with the PVC skirting

- ▶ Maximum floor covering thickness: 4 mm
- ▶ Good watertight seal for finishing floor-wall covers and floor-wall systems notably in industrial kitchens
- ▶ **Easy to install** thanks to the clip system



**Packaging**  
20 x 3 lm strips

- Heat the profile with a heat gun (temperature about 150°C) for the installation of the external corners
- Use a miter shear for a perfect cut
- Use SG916 for a perfect finish of the internal corners
- Slightly heat the profile if it whitens once installed
- Use either a double bonding adhesive, a dispersion contact adhesive or a double sided tape compatible with the PVC skirting

- ▶ Its rounded shape **makes it easier to clean** the floor-wall junction
- ▶ Gives a better look
- ▶ Limits the risk of piercing the floor covering
- ▶ **Prevents accumulation** of dirt and bacteria

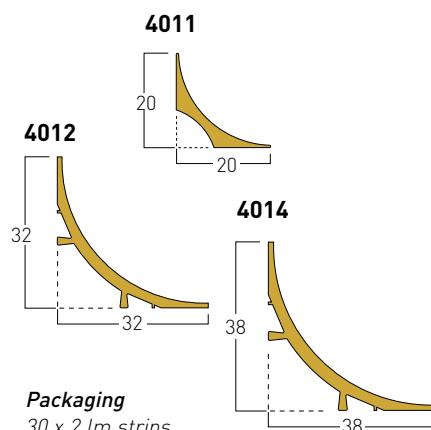



**Packaging**  
30 x 2 lm strips

- Use a mitre shear for a perfect cut

Colours and images are not contractual.

# FINISHES

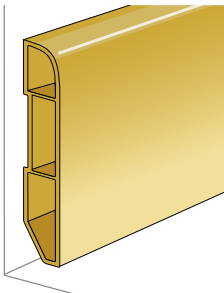
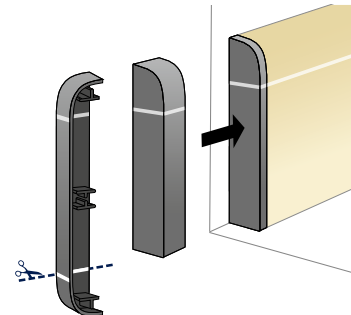
## SKIRTINGS

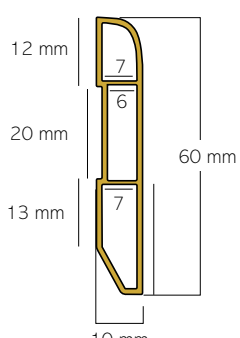
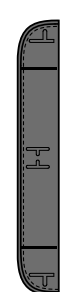
	Design skirting (PVC)	PVC Design Skirting Endcap
Description	 <p><b>SKIRTING (PVC)</b></p> <p>Vinyl Design Skirting for a perfect finish of Gerflor floorcoverings. 100% watertight, it could be installed in all environment.</p> <p><b>6086</b></p>	 <p><b>ENDCAP (PVC)</b></p> <p>These caps allow to cover PVC Design Skirting side</p> <p><b>6087</b></p>
Colours		 Anthracite grey 0001
Benefits / Colours	<ul style="list-style-type: none"> <li>▶ Thin and discrete, it ensures an elegant finish and hides the dilatation gaps</li> <li>▶ Designs of the Creation 30, Creation 55 and Rigid 30 collections are available</li> <li>▶ Some Creation 70 designs are available</li> <li>▶ The skirting is also available in a paintable white version</li> </ul>  <p><b>Packaging</b> 6 x 2 m</p>	<ul style="list-style-type: none"> <li>▶ PVC cap, aluminum color, fits all our PVC Design Skirtings</li> <li>▶ Can be used for one side of the skirting or the other</li> </ul>  <p><b>Packaging</b> Bag of 10 reversible caps</p>
Tips	<ul style="list-style-type: none"> <li>● Use a wood saw with fine teeth</li> <li>● Use a mitre box for the corner</li> <li>● Do not screw or nail</li> <li>● For more information contact the customer service</li> </ul>	<ul style="list-style-type: none"> <li>● Cut one end, glue it, press it</li> </ul>

# SKIRTINGS

## Design skirting (MDF)

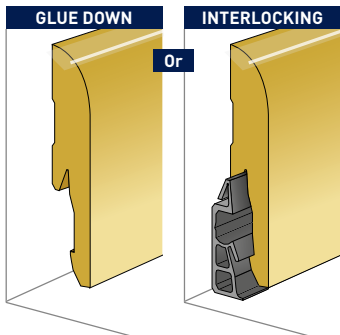

### SKIRTING (MDF)

MDF Design Skirting for a perfect finish of Gerflor floorcoverings.

**5947**

## Semi-rigid skirting

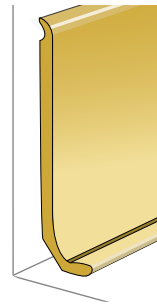

### VYNAFLEX

Semi-rigid PVC skirting to be placed on the wall

**0483 - 0482 - 0477**



- ▶ Available in all designs of Creation 30, Creation 55, Top Silence and Rigid collection
- ▶ Some Creation 70 designs are available
- ▶ It ensures an elegant finish and hides the dilatation gaps
- ▶ The skirting is also available in a paintable white version

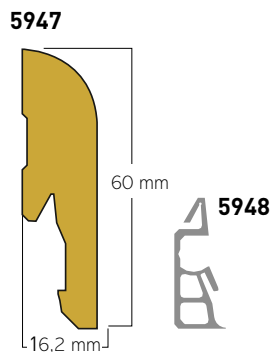

### Packaging

5947: 5 x 2.2 m

5948: 1 box of 30 clips

- Use a wood saw with fine teeth
- Use a mitre box for the corner
- For more information contact the customer service

- ▶ Solid colour
- ▶ Resistant to washing waters

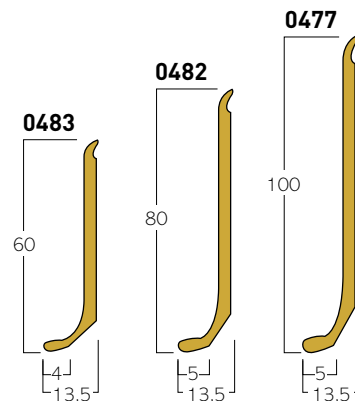

### Packaging

0483 / 0477: 25 x 3 lm strips

0482: 32 x 3 lm strips

- Use skirting corner Cutter to handle internal and external angles
- Use either a double bonding adhesive, a dispersion contact adhesive or a double sided tape compatible with the PVC skirting
- Apply an adhesion primer if the sub-floor is porous

Colours and images are not contractual.



# FINISHES

## STAIR SOLUTIONS

Gerflor has developed 2 solutions for installing a Vinyl floor on stairs to complement its range of floors:

### 1 Tarastep

- ▶ Install the base of the finishing clip onto the flat angle of the stair
- ▶ Install the Tarastep
- ▶ Clip the stair clip system

Adapted to rounded stair nosing.  
Mill the angle for straight stair nosing.  
For bird's beak stair nosing, fill the void beforehand.

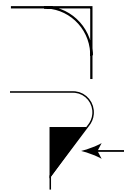
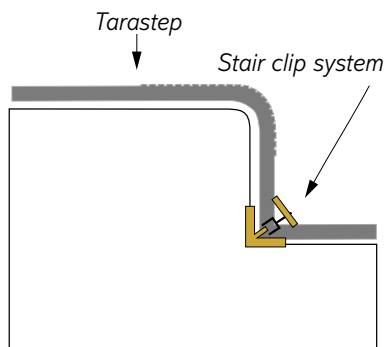

### 2 Stair nosing insert

- ▶ Install the vinyl flooring and the stair nosing by starting at the bottom of the stair
- ▶ Install the riser
- ▶ Install the stair nosing
- ▶ Install the flat of the stair
- ▶ Weld

Adapted to straight stair nosing, rounded stair nosing and bird's beak stair nosing.

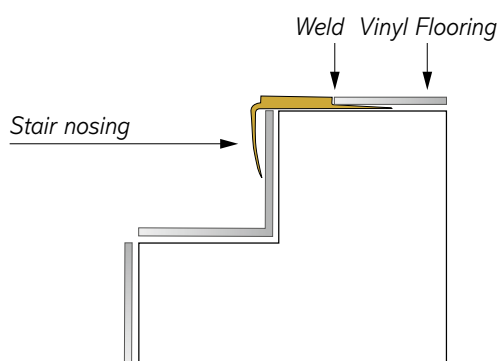

### Stair nosing insert

Description

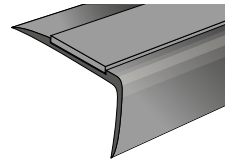

0503

ALUMINIUM STAIR NOSING  
T67 ALU

- ▶ Landing/stair harmony
- ▶ Guarantees floor covering durability

Colours



Benefits

- ▶ For a state-of-the-art stair finish
- ▶ Delivered with a black strip made out of carborandum for an improved anti-slipping action of the stair nosing

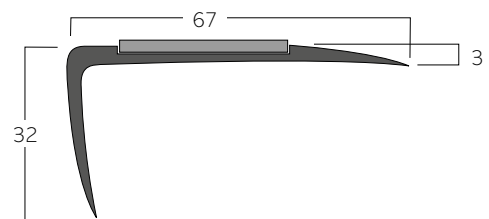

#### Packaging

10 x 3 lm strips + 10 carborandum strips

Tips

- Secure with flat head cross head countersunk stainless steel screws (not included)

# STAIR SOLUTIONS

## Stair nosing insert

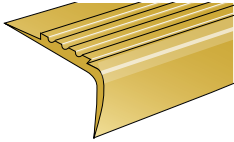

**0424 - 0462 - 0461**

GROOVED PVC STAIR NOSING

T49/4R - T49/3R - T49/2R

**Straight angles**

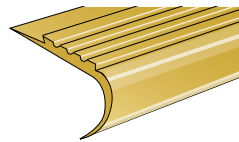

**0467**

GROOVED PVC STAIR NOSING

T27/3R

**Rounded angles and bird's beak**

- ▶ Grooves provide anti-slip protection
- ▶ Landing/Stair harmony
- ▶ Ensures floor covering durability



T49/4R - T49/3R - T49/2R

- ▶ Adapted to 2, 3 or 4 mm floor covering
- ▶ Weldable

**T49/2R - 0461**

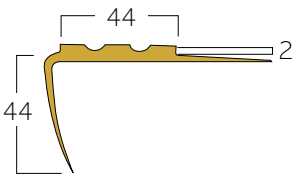

**T49/4R - 0424**

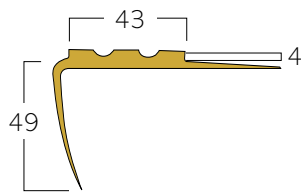

**T49/3R - 0462**

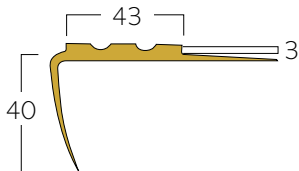

**Packaging**

10 x 3 lm strips

T27/3R

- ▶ Adapted to 3 mm floor covering
- ▶ Weldable

**T27/3R - 0467**

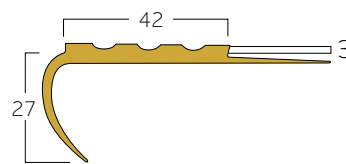

**Packaging**

10 x 3 lm strips

- Do not apply adhesive to the vertical part of the stair nosing
- Double bonding

Colours and images are not contractual.

# FINISHES

## PROFILE SOLUTIONS

Our profiles provide solutions to several problems concerning links between floors, walls or bare spots depending on the flooring thickness and technical requirements.

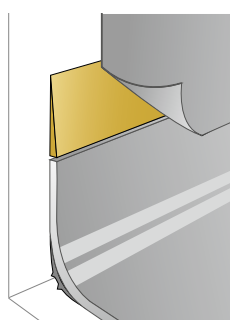

Diminishing profile

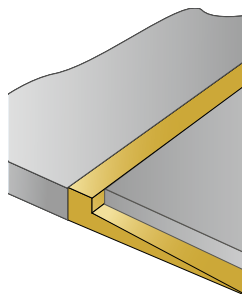

Connection profile



Aluminium coverstrip

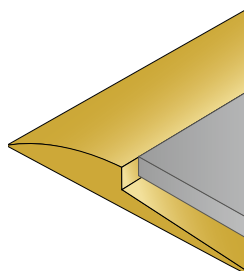

Ramp edges

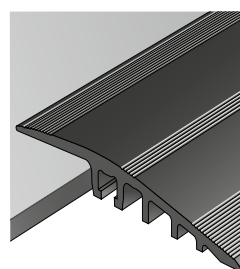

Aluminium profiles

**They in particular, allow two types of connections to be dealt with:**

**1**

### Connecting profiles

The connections between two floor coverings

- ▶ Floor/Floor
- ▶ Floor/wall

**Allow the link between two floor coverings with different thicknesses.**

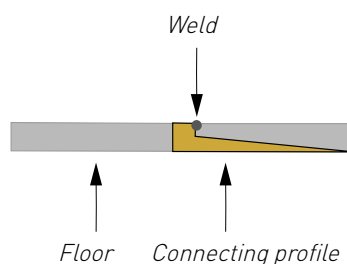

**2**

### Ramp edges



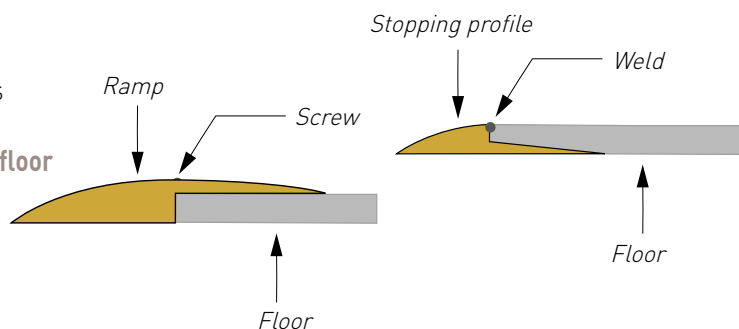

The vinyl floor/bare spot connections

**Protect the edging and prevent the floor covering from delaminating.**



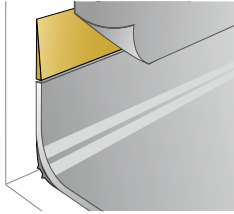
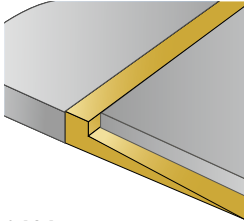
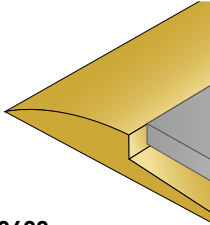
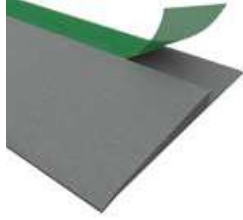

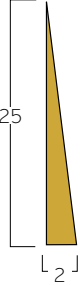
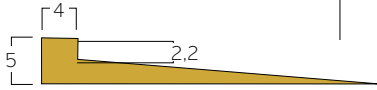
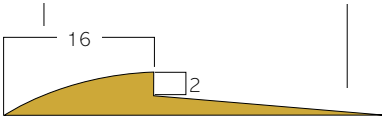
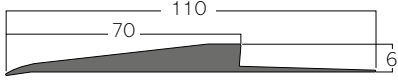

# PVC PROFILES

	Floor to wall connecting profile	Floor to floor connecting profile	Ramp edges	PVC access
Description	<p><b>DIMINISHING PROFILE</b></p>  <p><b>0490</b></p> <ul style="list-style-type: none"> <li>▶ Coving/wall covering connection</li> <li>▶ Used in laboratories, hospital shower systems, commercial kitchens</li> </ul>	<p><b>P1509</b></p>  <p><b>0496</b></p> <ul style="list-style-type: none"> <li>▶ These products allow the link between two-floor coverings to be made</li> </ul>	<p><b>P769</b></p>  <p><b>0493</b></p> <ul style="list-style-type: none"> <li>▶ Connect other surfaces and vinyl floors</li> </ul>	<p><b>HIGH TRAFIC PVC RAMP - 6 MM</b></p>  <p><b>0500</b></p> <ul style="list-style-type: none"> <li>▶ PVC ramp adapted to high mechanical traffic, fits 6 mm floorings</li> </ul>
Colours	 <p>Noir 6512</p>	 <p>Noir 6512 Gris 4203</p>	 <p>Noir 6512 Gris 4203</p>	 <p>Lead</p>
Benefits	<ul style="list-style-type: none"> <li>▶ Makes it easier to link the floor covering and wall.</li> <li>▶ <b>Hygienic.</b> Avoids bacteria accumulation</li> <li>▶ <b>Prevents the</b> floor covering from <b>tearing</b>, improves <b>durability</b> and ensures <b>watertightness</b></li> </ul> 	<ul style="list-style-type: none"> <li>▶ Junction between two floors of 2.2 mm and 5 mm</li> <li>▶ Floor covering can be welded to profile to create a watertight seal</li> <li>▶ <b>Can also be used as a finishing profile</b></li> </ul> 	<ul style="list-style-type: none"> <li>▶ Floor covering <b>welding</b> system</li> <li>▶ Suitable for 2 mm floors</li> <li>▶ Ensures watertight seal</li> <li>▶ Can also be used as a capping strip</li> </ul> 	<ul style="list-style-type: none"> <li>▶ Adapted to heavy mechanical traffic (pallet truck and forklift truck)</li> <li>▶ Easy to install (preadhesive) &amp; easy to cut</li> <li>▶ Water resistant installation</li> </ul> 
Tips	<ul style="list-style-type: none"> <li>● Bonding with acrylic adhesive</li> </ul> <p><b>Packaging</b> 2 rolls of 25 lm</p>	<ul style="list-style-type: none"> <li>● Polychloroprene double bonding</li> </ul> <p><b>Packaging</b> 30 x 3 lm strips</p>	<ul style="list-style-type: none"> <li>● Double bonding</li> </ul> <p><b>Packaging</b> 2 rolls de 25 lm</p>	<ul style="list-style-type: none"> <li>● No floor damage</li> </ul> <p><b>Packaging</b> 8 lengths x 2lm / box</p>



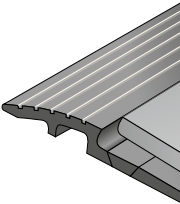
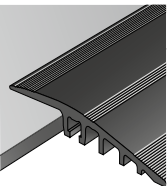
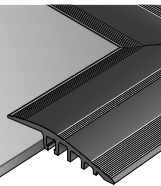
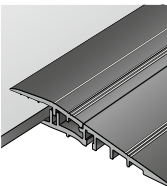
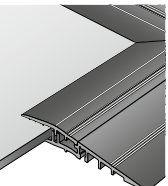

Colours and images are not contractual.

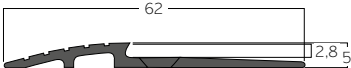
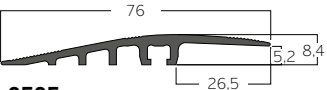
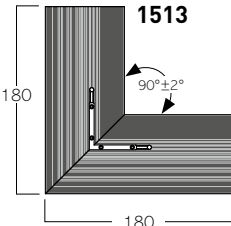
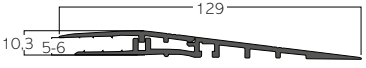
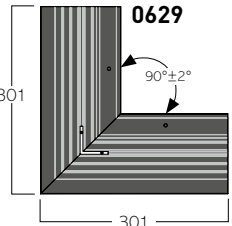
# FINISHES

## ALUMINIUM RAMP EDGES

		Srewed		Looselay		
Description	 <p><b>ALUMINIUM RAMP</b> 2.8 MM</p> <p>▶ Access ramps resistant to high traffic and humidity</p> <p><b>0504</b></p>	<p><b>ALUMINIUM RAMP</b> 5-6 MM</p>  <p><b>0505</b></p>	<p><b>ALUMINIUM CORNER</b> 5-6 MM</p>  <p><b>1513</b></p>	<p><b>LOOSELAY ALUMINIUM RAMP</b> 5-6 MM</p>  <p><b>0609</b></p>	<p><b>LOOSELAY ALUMINIUM CORNER</b> 5-6 MM</p>  <p><b>0629</b></p>	<p>▶ Access ramps resistant to high traffic and humidity</p>
Colours	 0001	 0001				
Benefits	<p>Product suitable for floor coverings of:</p> <ul style="list-style-type: none"> <li>▶ 2-3 mm <b>(Creation 70, Creation 55, Creation 30, ...)</b></li> </ul>  <p><b>0504</b></p> <p><b>Packaging</b> 10 x 3 lm ramps</p>	<ul style="list-style-type: none"> <li>▶ Smooth shape for more utilisation comfort</li> <li>▶ Connectors for a perfect connection of 2 profiles</li> <li>▶ Pre-assembled corners for an easier installation and a perfect finish</li> </ul> <p>Products suitable for floor coverings of:</p> <ul style="list-style-type: none"> <li>▶ 5-6 mm <b>(Attraction®, GTI MAX, Creation 70 Clic System, Creation 55 Clic, Creation 30 Clic, ...)</b></li> </ul>  <p><b>0505</b></p>  <p><b>1513</b></p> <p><b>Packaging</b> 5 x 3 lm ramps (0505) / 4 corners (1513)</p>		 <p><b>0609</b></p>  <p><b>0629</b></p> <p><b>Packaging</b> 5 x 3 lm ramps (0609) / 4 corners (0629)</p>		
Tips		<ul style="list-style-type: none"> <li>• Delivered with fixation kit</li> <li>• Screwing of the ramp to the floor with flat cross head countersunk stainless steel screws (Aluminium ramp 5-6 mm and aluminium corner)</li> </ul>		<ul style="list-style-type: none"> <li>• Looselay installation without damaging the subfloor (looselay ramp and looselay corner)</li> </ul>		

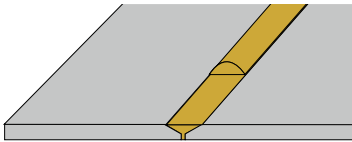
# WELDING SOLUTIONS

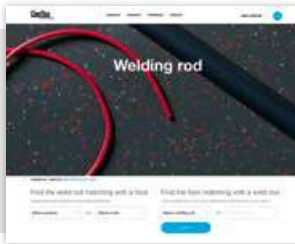
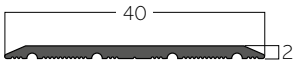
	Floor to floor (same thickness) connecting profile	Hot weld
Description	<p><b>ALUMINIUM COVERSTRIP</b></p>  <p><b>0632</b></p> <ul style="list-style-type: none"> <li>▶ Easthetic link between two floor coverings</li> </ul>	<p><b>WELDING RODS</b></p> <ul style="list-style-type: none"> <li>▶ This is used for all types of PVC floors, for coving sport floors</li> <li>▶ Ensures a complete watertight seal</li> </ul> <p><b>Gerflor has a large range of rods available</b></p> <p>Ø 4 mm / Ø 4.1 mm / Ø 5 mm / Ø 6 mm</p>   <p><i>The welding rod is placed in the chamfer between two floor coverings. When heated, it melts and fills the entire space to ensure complete watertight seal.</i></p>
Colours	 Alu inc	<p><b>WELDING ROD AND FLOORING MATCHING TOOL</b></p> <p><a href="http://www.gerflor.com/servicesprofessionals/welding-rods-matching.html">http://www.gerflor.com/servicesprofessionals/welding-rods-matching.html</a></p> 
Benefits	<ul style="list-style-type: none"> <li>▶ 40 mm preadhesive coverstrip, allowing junction and extension gap between two floor coverings of same thickness</li> </ul> 	<ul style="list-style-type: none"> <li>▶ <b>CR40:</b> Floor/floor weld - Code 0585</li> <li>▶ <b>CR41:</b> Shower wall weld - Code H231</li> <li>▶ <b>CR50:</b> Welding of sport floors - Code H209</li> </ul> <p><b>Specific weld rods</b></p> <ul style="list-style-type: none"> <li>▶ <b>CR50:</b> Weld, Tarasafe Plus, floor repairs on special order - Code H009</li> <li>▶ <b>CA72:</b> Triangular rod for commercial kitchen floor to base welding - Code H007</li> <li>▶ <b>CR60:</b> Welding of sport floors, repair on special order - Code H011</li> <li>▶ <b>BBR40:</b> 100% Bio-based plasticizer rod for Mipolam Symbioz</li> <li>▶ <b>MCR40:</b> Multicolor rod for Mipolam Accord &amp; Affinity - Code H058</li> </ul>
Tips	<p><b>Packaging</b></p> <p>25 lengths/box / 0,90 m x 40 mm</p>	<p><b>Packaging</b></p> <p>CR40, BBR40, CR41, CR50, CA72: 100 lm. coil            CR60: 60 lm. coil            MCR40: 50 lm. coil</p> <p>Please contact us for further information on weld rods</p> <ul style="list-style-type: none"> <li>● For a better weld the correct grooving should be performed.</li> <li>● Use an adapted nozzle (Ultra Speed Nozzle).</li> </ul>

Colours and images are not contractual.





























# FINISHES

## ENTRANCE SOLUTIONS

Three cleaning zones to be covered at the entrance to a building

Each zone has a specific "cleaning" role:



ZONE 1	ZONE 2	ZONE 3																
																		
<p><b>RIBBED RUBBER INSERT</b></p> <table border="1"> <tr> <td><b>Romat</b> Frequent traffic (500 p/day)</td> <td></td> </tr> <tr> <td><b>Romat GT</b> Heavy traffic (500 to 2,000 p/day)</td> <td></td> </tr> <tr> <td><b>Romat reverse</b> Intensive traffic (&gt; 2,000 p/day)</td> <td></td> </tr> </table>	<b>Romat</b> Frequent traffic (500 p/day)		<b>Romat GT</b> Heavy traffic (500 to 2,000 p/day)		<b>Romat reverse</b> Intensive traffic (> 2,000 p/day)		<p><b>TEXTILE INSERT</b></p> <table border="1"> <tr> <td><b>Romat</b> Frequent traffic (500 p/day)</td> <td></td> </tr> <tr> <td><b>Romat GT</b> Heavy traffic (500 to 2,000 p/day)</td> <td></td> </tr> </table> <p><b>RUBBER GRATE INSERT</b></p> <table border="1"> <tr> <td><b>Romat reverse</b> Intensive traffic (&gt; 2,000 p/day)</td> <td></td> </tr> </table>	<b>Romat</b> Frequent traffic (500 p/day)		<b>Romat GT</b> Heavy traffic (500 to 2,000 p/day)		<b>Romat reverse</b> Intensive traffic (> 2,000 p/day)		<p><b>DIRT-TRAPPING MAT</b></p> <table border="1"> <tr> <td><b>Ronet</b> Frequent traffic (500 p/day)</td> <td></td> </tr> <tr> <td><b>Roclean</b> Heavy traffic (&gt; 500 p/day)</td> <td></td> </tr> </table>	<b>Ronet</b> Frequent traffic (500 p/day)		<b>Roclean</b> Heavy traffic (> 500 p/day)	
<b>Romat</b> Frequent traffic (500 p/day)																		
<b>Romat GT</b> Heavy traffic (500 to 2,000 p/day)																		
<b>Romat reverse</b> Intensive traffic (> 2,000 p/day)																		
<b>Romat</b> Frequent traffic (500 p/day)																		
<b>Romat GT</b> Heavy traffic (500 to 2,000 p/day)																		
<b>Romat reverse</b> Intensive traffic (> 2,000 p/day)																		
<b>Ronet</b> Frequent traffic (500 p/day)																		
<b>Roclean</b> Heavy traffic (> 500 p/day)																		

## ENTRANCE MATS

- ▶ Eliminate dust, moisture and other residue from visitors' feet as efficiently as possible at the entrance to a building
- ▶ Prevent premature soiling and wear of floor coverings.

### QUICKMAT TILES



Modular entrance mat that can be incrustated in Gerflor LVT floor covering without damaging the subfloor. It helps to scratch the underside of shoes and protects the building from outside dirt. For areas with frequent pedestrian traffic (up to 2000 people per day).

- ▶ Packaging: 1 sqm box

#### QUICKMAT TILES

**Ref. 1725** - 23 x 75 cm planks

#### QUICKMAT PROFILES

**Ref. 1726** (tube of 4x2 lm profiles)

#### QUICKMAT TILE ANGLES

**Ref. 1727** (box of 4 angles)

### LOOSELAY ROMAT GT - INSERT KIT



**Ref. 1719** - 1.5 x 1 m

#### For pedestrian traffic only.

Entrance mat affording floors of buildings efficient and sustainable protection from pedestrian traffic by forming a barrier to outside dirt. Thanks to its loose-lay installation, the mat can be installed without damaging the surface. Adapted for an important pedestrian traffic (up to 2000 people per day).

#### This kit contains:

- ▶ 1 mat
- ▶ 4 frames composed of 4 lower and 4 upper profiles
- ▶ 4 external pre-assembled corners
- ▶ 60 5-7 screws
- ▶ 1 Installation guideline

### KIT ESPLANADE 9000



**Ref. 1700** - 1.5 x 1.5 m

Kit for the incrustation of an ESPLANADE 9000 mat in an area covered with Attraction®, GTI, Creation 55 Clic, Creation 70 Clic. The closed conception of the mat enable to scratch the underside of shoes and increase the durability of the floors. It resists to intense pedestian traffic (up to 5000/day) and to mecanial traffic.

- ▶ Packaging: 2.5 sqm kit: 3 mats modules, 4 upper and 4 lower profiles, screws.

# TECHNICAL SOLUTIONS

**Shower system.....299**

**Accessibility .....300-301**

**LVT Underlayers.....302-303**

**Specific products.....304-305**

- Isolating membranes 305
- ESD copper strip 305
- Protection 305

**Adhesives and tapes.....306-307**

Gerflor offers a full range of technical solutions such as the shower system, copper strips, adhesives or tools in order to provide all the technical requirements on site.





# TECHNICAL SOLUTIONS

## SHOWER SYSTEM

A complete floor and wall solution with a choice of two floor coverings, one wall covering and seven accessories.

- Safety: Grained floor covering with slip resistance (Elegance SD, Tarasafe Ultra H<sub>2</sub>O, Standard, Geo, Ultra Compact)
- Watertight system floor/wall junction
- System which guarantees hygiene
- Combination of colours: 31 wall references and 16 floor references
- Access for all

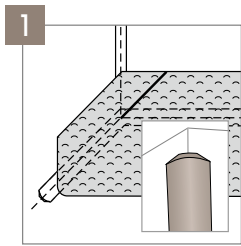

Cove former for internal wall angles CA 12 - H204



Perfect CR 41 wall weld - H231

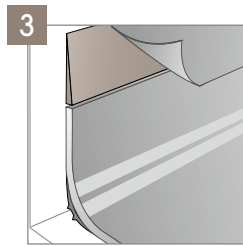

Diminishing profile - 0490

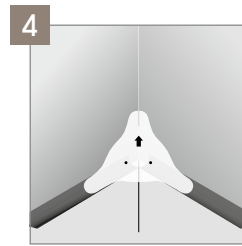

Clean Corner System IN 058S

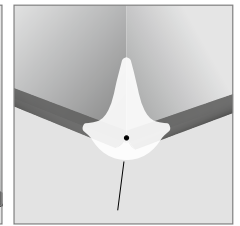

Clean Corner System OUT 058R

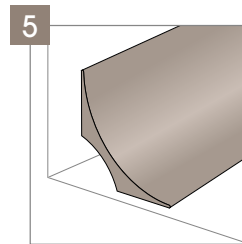

Cove former 4011

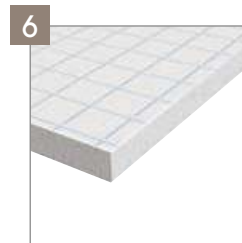

Tarafoam: acoustic insulation sublayer - 997C



PVC drain with inox grid - H090



Drains - H112 / H113 SITAR / SITAR V



Shower threshold - 0469

The threshold has been developed in 3 colours: grey, beige and blue in order to answer to the specific requirement of Alzheimer units (no contrast).

- gris
- beige clair
- bleu

# TECHNICAL SOLUTIONS

## SPECIFIC PRODUCTS - ACCESSIBILITY



# SPECIFIC PRODUCTS - ACCESSIBILITY



## Warning Surfaces

ALERTILE, self-adhesive or weldable tactile slab

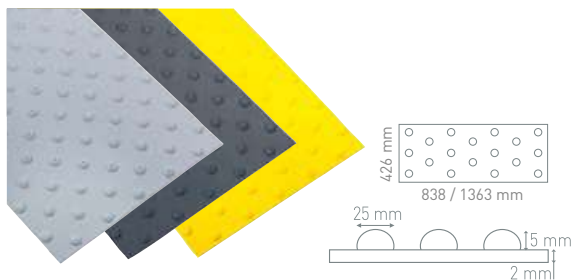

Dimensions: 426 x 1363 mm / 426 x 838 mm  
 Packaging: 8 units per box (838 mm)  
 4 units per box (1363 mm)  
 Codes: 058B (838mm) / 058A (1363mm)

EASYPLOT, the aesthetic solution for warning



Packaging: Kit of 198 studs (6 planks de 33 studs)  
 approx. 1.3 m x 0.4 m  
 Codes: 059C (Grey, Black) - 059D (Alu)



## Guiding

EASYGUIDE, the self-adhesive solution for guiding



Packaging: Box of 6 slabs 300 x 220 mm (4 bars/slab) for 1.8 m of guideline  
 Code E219



## Signage

Personalised cut-to-size system



For more information, please refer to the "A Global Solution for Accessibility" brochure.





For more information, please refer to the "Creative Design Service"





# TECHNICAL SOLUTIONS

## UNDERLAYERS FOR LVT COLLECTIONS

	Creation 30/55/70 CLIC	Creation 30/55 CLIC
Description	<p>GERFLOR ACOUSTIC 15 dB</p>  <p><b>1798</b> ▶ Sound absorption underlay in roll</p> <p>✚ ALU TAPE <b>5050</b></p> 	<p>GERFLOR SILENCE PLUS 19 dB</p>  <p><b>5949</b> ▶ Sound absorption underlay in accordion</p> <p>✚ ALU TAPE <b>5050</b></p> 
Benefits	<ul style="list-style-type: none"><li>▶ Reduces impact noise up to <b>15 dB</b></li><li>▶ Adapted to <b>all traffic types</b></li><li>▶ Thickness: <b>0.93 mm</b></li></ul>	<ul style="list-style-type: none"><li>▶ Reduces impact noise up to <b>19 dB</b></li><li>▶ Adapted to <b>medium traffic</b></li><li>▶ Thickness: <b>1.5 mm</b></li></ul>
Tips	<p><b>Packaging</b> 1798 - 1 x 15 lm = 15 sqm 5050 - 7.5 cm x 25 lm Consumption: 1 Alu Tape roll for 2 rolls of underlayer</p> <ul style="list-style-type: none"><li>● Underlay is rolled on reverse</li><li>● Use Alu Tape to connect 2 rolls</li><li>● Refer to technical installation guidelines to check the approved product</li></ul>	<p><b>Packaging</b> 5949 - 1.18 x 8.5 lm = 10 sqm 5050 - 7.5 cm x 25 lm: 1 Alu Tape roll for 3 boxes of underlayer</p> <ul style="list-style-type: none"><li>● Printed side on top</li><li>● Use Alu Tape to connect 2 bands</li><li>● Refer to technical installation guidelines to check the approved product</li></ul>

## Creation 30/55

### GERFLOR SMART FIX 16 dB



**1698**

- ▶ Underlay with self-adhesive surface
- ▶ Sound absorption underlay in roll

- ▶ For a loose lay installation of LVT dry back.
- ▶ Reduces impact noise up to **16 dB**
- ▶ Adapted to **all traffic** types
- ▶ Thickness: **2 mm**

#### **Packaging**

1 x 7.5 lm = 7.5 sqm

- Fleece side: on the subfloor
- Adhesived side: under the LVT
- Refer to technical installation guidelines to check the approved product



# TECHNICAL SOLUTIONS

## SPECIFIC PRODUCTS

Gerflor provides a set of products providing solutions to specific problems such as accessibility, insulation, maintenance of floors and electrical conductivity of our floors.



Isolating membranes





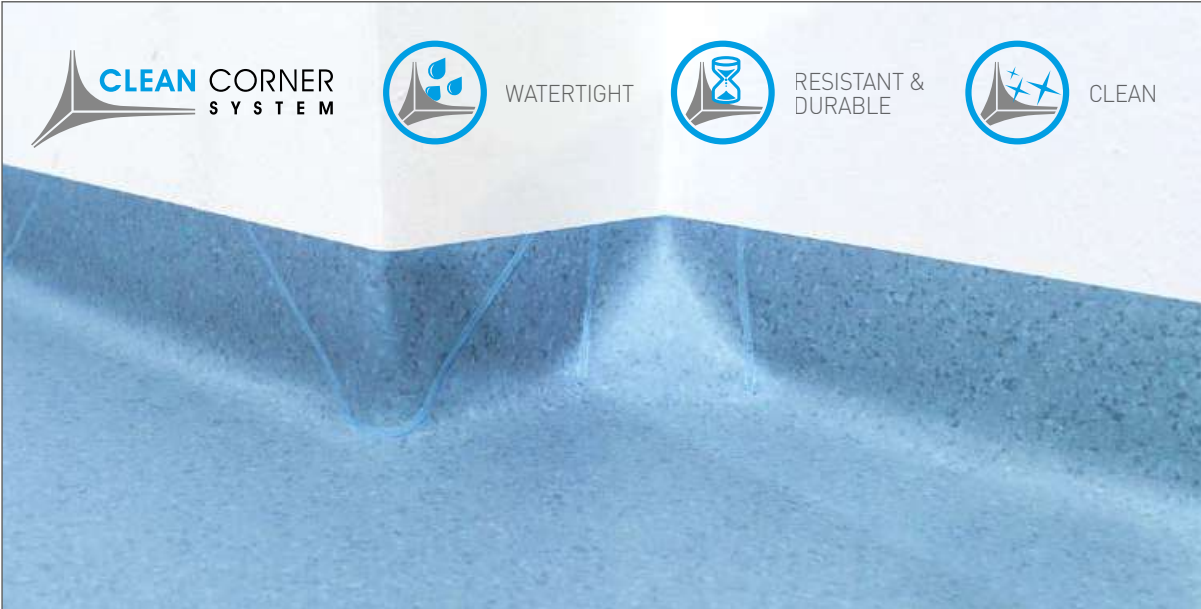

ESD copper strip



Clean Corner System for all Gerflor floors

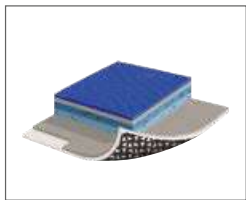



## SPECIFIC PRODUCTS

	Isolsport	Tarafoam	Protection	Copper strip
Description	<p>VINYL ISOLATING MEMBRANE</p>  <p><b>0829 0002</b></p> <p><b>Specially designed for sports</b></p> <p>For installation on concrete subfloors</p>	<p>COMFORT VERSION OF THE SHOWER SYSTEM</p>  <p><b>997C 6792</b></p>	<p>FLOOR PROTECTION</p>  <p><b>058X 0001</b></p> <p>Preserve the floors laid down until the site is delivered</p>	<p>ESD COPPER STRIP</p>  <p><b>0586 0001</b></p> <p>Copper strip enabling earthing</p>
Benefits	<ul style="list-style-type: none"> <li>▶ Vinyl isolating membrane, double side on non woven glass fibre with backing design made up of 3-branch star foam pads.</li> <li>▶ Its design enables loose laying on sensitive subfloors (risks of humidity, coated, etc.) when it is associated with a Taraflex® sporting floor. The raised effect allows humidity to circulate.</li> <li>▶ Thickness: 1.7 mm</li> </ul>	<ul style="list-style-type: none"> <li>▶ Provides <b>acoustic insulation for the shower system</b> (15 dB) and comfort under foot.</li> <li>▶ Thickness: 2 mm</li> </ul>	<ul style="list-style-type: none"> <li>▶ Effective protection against scratches, stains, slip and other external stresses.</li> <li>▶ Good hold on the floor for a safe use</li> <li>▶ Reusable</li> </ul>	<ul style="list-style-type: none"> <li>▶ For electro-conductive floor coverings such as Elegance EL5, Technic EL5, GTI EL5, Affinity EL7, Robust EL7</li> <li>▶ Width 10 mm, thickness 0.08 mm</li> </ul>
Tips	<p><b>Packaging</b> 1 x 45 lm roll</p> <ul style="list-style-type: none"> <li>● Bond well at doors with PU adhesive to prevent delamination.</li> <li>● Keep the raised surface, floor side, on the periphery</li> <li>● Edge to edge installation</li> <li>● Bond vinyl floors with Gertec adhesive</li> </ul>	<p><b>Packaging</b> Roll of 2 m x 20 lm - 40 m<sup>2</sup></p> <ul style="list-style-type: none"> <li>● Levels out around the edge of the room</li> <li>● Acrylic bonding</li> <li>● Edge to edge installation</li> </ul>	<p><b>Packaging</b> Roll of 1 x 50 lm - 50 m<sup>2</sup></p>	<p><b>Packaging</b> 1 x 200 lm roll</p> <ul style="list-style-type: none"> <li>● Prevent discontinuity between the angles by folding it back onto itself</li> </ul> <p><i>Colours and images are not contractual.</i></p>

# TECHNICAL SOLUTIONS

## ADHESIVES AND TAPES

Gerflor has developed specific bonding solutions to make it easier to install its products.

Adhesives				
Description	<p>GERPUR M</p>  <p><b>086C 0083</b></p> <p><b>Specially designed for sports</b></p> <p><b>Only for Dry Tex™ System</b> (bonding of Taraflex sport floors with non-woven backing)</p>	<p>GERTEC</p>  <p><b>0991 0991</b></p> <p>Application on floors with old vinyl floor covering for renovation or on Isolsport</p>	<p>GERFIX SUPER E 120</p>  <p><b>0973 0973</b></p> <p>Apply on a hydraulic base or resurfacing</p>	
	Benefits	<ul style="list-style-type: none"> <li>▶ Bonding on new and old humid concrete subfloor</li> <li>▶ Mono component PU adhesive, reactive to humidity which enables the DTX material to be fully bonded in humid environment (no restriction of humidity levels with the exception of surface water)</li> <li>▶ Consumption: 400 to 450 g/m<sup>2</sup></li> </ul>	<ul style="list-style-type: none"> <li>▶ Acrylic adhesive</li> <li>▶ Adapted to Isolsport and other sport floors</li> <li>▶ Consumption: 150 to 200 g/m<sup>2</sup></li> </ul>	<ul style="list-style-type: none"> <li>▶ Acrylic adhesive</li> <li>▶ Consumption: 300 to 350 g/m<sup>2</sup></li> </ul>
		Tips	<p><b>Packaging</b> 15 kg bucket</p> <ul style="list-style-type: none"> <li>● To be applied with ergonomic trowel for rigid adhesive and B1 blade</li> </ul>	<p><b>Packaging</b> 20 kg bucket</p> <ul style="list-style-type: none"> <li>● To be applied with a stiff aluminium trowel and blade A4 Standard TKB</li> </ul>

# ADHESIVES AND TAPES

## Hook & loop and double sided tape for textile backing

D75



**0534 0001**

Width: 75 mm

- ▶ D75 enables installation of vinyl floor coverings with textile backing on the perimeter and under joints.
- ▶ Time saving and cleanliness by comparison with a bonded system.
- ▶ No gumming time and no smell.

**Packaging**  
1 x 25 lm roll

## Non-migrating double sided tapes

FIX&FREE 100



**058U 0001**

Width: 100 mm

- ▶ New double-sided tapes in order to install and uninstall our floorcovering easily, without damaging the subfloor. This is particularly useful for "ephemeral areas" (in retail for instance) of for renovation of subfloor containing asbestos.
- ▶ Fix&Free 100 is suitable for textile backing floorcovering. Fix&Free 740 is suitable for Creation Clic and GTI.
- ▶ Time saving and cleanliness by comparison with a bonded system.
- ▶ No gumming time and no smell.

**Packaging**  
1 x 50 lm roll

FIX&FREE 740



**058W 0001**

Width: 740 mm

**Packaging**  
1 x 25 lm roll



# SPORT FINISHES

- Marking .....309**
- Specific Products .....310-311**
- Adhesives and tapes.....312**
- Tools .....313**

We provide finishing solutions suitable for sports floor coverings such as permanent or temporary line marking solutions.



# SPORTS FINISHES

## MARKING



### Permanent Game Lines (paint)

DESCRIPTION	ARTICLE CODE	COMPONENTS
KIT TLD AQUA BASKET	085V0001	4 red paint's can, 4 hardener's can, 9 adhesive tapes and 1 roller
KIT TLD AQUA BADMINTON	085W0001	3 black paint's can, 3 hardener's can, 7 adhesive tapes and 1 roller
KIT TLD AQUA TENNIS	085X0001	3 white paint's can, 3 hardener's can, 7 adhesive tapes and 1 roller
KIT TLD AQUA HANDBALL	085Y0001	4 yellow paint's can, 4 hardener's can, 9 adhesive tapes and 1 roller
KIT TLD AQUA VOLLEY	085Z0001	2 blue paint's can, 2 hardener's can, 3 adhesive tapes and 1 roller

### Temporary Game Lines (tape)



DESCRIPTION	ARTICLE CODE	USE
3 M TAPES BLACK (**)	H1970002	For game lines
3 M TAPES WHITE (**)	H1970004 (*)	For game lines - White = Tennis
3 M TAPES RED (**)	H1970005	For game lines - Red = Basket
3M TAPES BLUE (**)	H1970006	For game lines - Blue = Volley

### Game Line Equipment (Permanent & Temporary)

DESCRIPTION	ARTICLE CODE	USE
GAME LINE MARKING DEVICE	087W0001	Circular line marking of up 9 m radius can be achieved with this device.
GAME LINE MARKING DEVICE AND CIRCLE CUTTER	087X0001	<p><b>COMPONENTS</b></p> <ul style="list-style-type: none"> <li>① Marking head with 50 mm adhesive marking tape</li> <li>② Marking head with 19 mm protective tape</li> <li>③ Extension poles</li> <li>④ Pole-connections</li> <li>⑤ Centre-part with 2 suction cups</li> <li>⑥ Sheet metal guides for straight lines</li> <li>⑦ Transporting case ABS</li> <li>⑧ Case for extension poles</li> </ul> <p>Circle cutter (optional for only 087X0001)</p>

(\*)White color can be used for any other monosport court.  
 (\*\*)To be installed on Taraflex® Range except on canvas or tennis embossing.

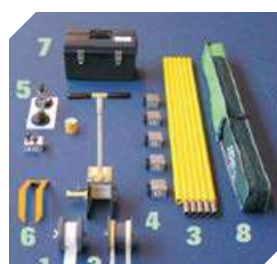

Game Line Marking Device

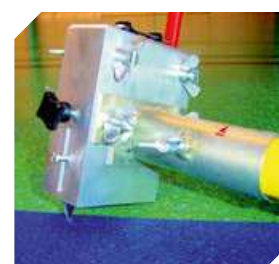

Circle Cutter

# SPORTS FINISHES

## SPECIFIC PRODUCTS: ISOLATING MEMBRANE & CLEANING DETERGENTS

	Bateco	Sport floor maintenance
Description	 <p><b>PROTECTIVE SURFACE</b> <b>Specially designed for sports</b></p> <p><b>H3756801 (customized lengths)</b> <b>HM126801 (standard lengths at 20 lm)</b> <b>HM066801 (standard lengths at 30 lm)</b></p> <p><b>Suitable for gymnasium / reception hall versatility</b></p>	 <p><b>TRACIFLEX</b></p> <p><b>085P 0001</b></p> <ul style="list-style-type: none"> <li>▶ Multipurpose detergent for cleaning the vinyl sport floors (shoe marks and contact marks)</li> <li>▶ Also suitable for floors which are difficult to clean</li> <li>▶ For daily or weekly maintenance</li> </ul>
Benefits	<ul style="list-style-type: none"> <li>▶ <b>Protective surface</b> made from black calendered and grained plasticised vinyl.</li> <li>▶ Taraflex Bateco is especially designed to protect sport floors in the event of non-sports use of the room. It prevents marking by chairs, tables, heels on the sport floor.</li> <li>▶ Thickness: 1.5 mm</li> </ul>	<ul style="list-style-type: none"> <li>▶ Removes resin from Handball courts</li> <li>▶ Recommended in sport room</li> </ul>
Tips	<p><b>Packaging</b> 1 x 20 lm roll / 1 x 30 lm roll</p> <ul style="list-style-type: none"> <li>● Edge to edge installation</li> <li>● Strips can be secured with single-sided adhesive tape AT7</li> </ul>	<p><b>Packaging</b> 1 l can</p> <ul style="list-style-type: none"> <li>● Traciflex may be sprayed on stubborn stains</li> </ul>





## SPECIFIC PRODUCTS: CLEANING DETERGENTS

### Sport floor maintenance



TANEX TROPHY

**085E 0001**

- ▶ Multipurpose detergent for cleaning the vinyl sport floors (shoe marks and contact marks)
- ▶ Also suitable for floors which are difficult to clean
- ▶ For weekly maintenance

- ▶ For all sport floors



**Packaging**  
5 l can

### Protocols® Floor Maintenance



SPRAY  
TARACLEAN

**085A 0010**

- ▶ Spray cleaner to remove occasional and tough stains, notably resin marks

- ▶ Suited to all types of floors treated with Protocols®
- ▶ Easy and quick to use

**Packaging**  
Box of 12 pieces

*Colours and images are not contractual.*

# SPORTS FINISHES

## ADHESIVES AND TAPES

### Double sided tapes for sport floors

Description	<div data-bbox="338 490 603 817" data-label="Image"> </div> <div data-bbox="635 488 805 519" data-label="Caption"> <p>D200 / D300</p> </div> <div data-bbox="335 837 592 866" data-label="Text"> <p><b>H208 0007 / 085R 0001</b></p> </div> <div data-bbox="335 896 643 952" data-label="Text"> <p><b>D200: Special double-sided tape for wood floors</b></p> </div> <div data-bbox="335 987 649 1043" data-label="Text"> <p><b>D300: Special double -sided tape for concrete</b></p> </div> <div data-bbox="335 1066 504 1093" data-label="Text"> <p>Width: 100 mm</p> </div>	<div data-bbox="979 490 1241 817" data-label="Image"> </div> <div data-bbox="1268 488 1334 519" data-label="Caption"> <p>AT7</p> </div> <div data-bbox="975 837 1096 866" data-label="Text"> <p><b>H206 0001</b></p> </div> <div data-bbox="975 896 1163 925" data-label="Text"> <p><b>Single-side tape</b></p> </div> <div data-bbox="975 1066 1144 1093" data-label="Text"> <p>Width: 100 mm</p> </div>
Benefits	<ul style="list-style-type: none"> <li>▶ Adapted to temporary installation on wood floors or concrete</li> <li>▶ Requires a test on site for validation</li> </ul> <p><b>Packaging</b> 0.1 x 50 lm roll (100 mm x 50 m)</p>	<ul style="list-style-type: none"> <li>▶ Black</li> <li>▶ Bonds without leaving marks, non migrating</li> </ul> <p><b>Holds strips:</b></p> <ol style="list-style-type: none"> <li>1. During non sportive events</li> <li>2. Enables the material to be secured on the tube at the time of winding</li> <li>3. Holds strips during the storage time</li> </ol> <p><b>Packaging</b> 0.1 x 33 lm roll (100 mm x 33 m)</p>
Tips	<p><i>Required material:</i></p> <ul style="list-style-type: none"> <li>● Double side tape reel</li> <li>● Unroller for double sided tapes H372001</li> </ul> <div data-bbox="525 1601 839 1971" data-label="Image"> </div>	<p><i>Required material:</i></p> <ul style="list-style-type: none"> <li>● AT7 tape reel</li> <li>● Unroller for single sided tapes H367 0003</li> </ul> <div data-bbox="1187 1601 1489 1971" data-label="Image"> </div>

Refer to the product glossary for information on colours and packaging

# TOOLS - SPORT

## Storage equipment

DESCRIPTION	ARTICLE CODE	USE
NAIROD PALLET (brand new)	087Q0057	For transportation and storage of mobile court (160 x 120 x 180)
NAIROD PALLET (2 <sup>nd</sup> hand)	087Q0057	

DESCRIPTION	ARTICLE CODE	USE
SERVING TROLLEY Portable floors	087A0035	To wind and unwind Bateco or portable floors
SERVING TROLLEY Bateco	088F0001	
UNWINDING TROLLEY Bateco	088D0001	

DESCRIPTION	ARTICLE CODE	USE
STORAGE RACK FOR 4 ROLLS DPP4	087E0039	For BATECO storage
STORAGE RACK FOR 4 ROLLS DPP4	088N0001	For portable floors
STORAGE RACK FOR 6 ROLLS DPP6	08800001	For BATECO storage
STORAGE RACK FOR 6 ROLLS DPP6	088K0001	For portable floors
STORAGE RACK FOR 8 ROLLS DPP8	087B0037	For BATECO storage
STORAGE RACK FOR 8 ROLLS DPP8	088S0001	For portable floors
STORAGE RACK FOR 10 ROLLS DPP10	088J0001	For BATECO storage
STATIC WALL STORAGE RACK	088E0001	

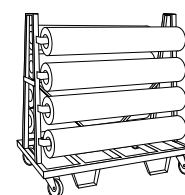
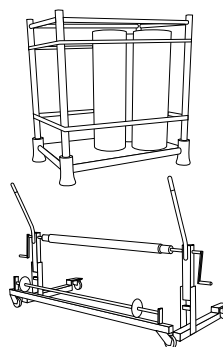

## Accessories

DESCRIPTION	ARTICLE CODE	USE
CONES	087F0040	Special cones connect the inside cardboard tube with poles. This specific element is only suitable for round tubes poles
GUIDING POLE	H5390023	Fixed at the front of the storage rack to easily wind and unwind Bateco or portable floors
MOTORISED UNWINDING KIT	088G0001	Motorised system to easily wind and unwind Bateco or sports floors
HOLDING STRAP	H2950001	Holding strap to prevent roll unwinding

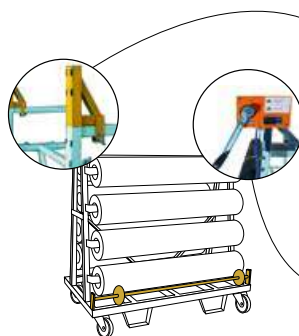

**087G0042**

**FRAME EXTENSION PAIR:**

The frame extension pair is only to support the roll hoist. It enables the lifting of rolls to the highest position on roll stands.

Only if roll length up to 28 lm, to be ordered with storage racks

**H4000012**

**ROLL HOIST PAIR:**

Additional device for easy upload or download of rolls.





.....

# SPECIFICATIONS

..... PAGES .....

# 314/321

.....



**Gerflor specifications ..... 316-321**

# GERFLOR SPECIFICATIONS

## HEALTHCARE - HOSPITAL - CLINIC - RETIREMENT HOME



MIPOLAM HOMOGENEOUS		PREMIUM		TARALAY MULTILAYERED						TECHNICAL TILES			
Compact	Compact	Comfort	Compact	Textile backing	Comfort	Compact	Compact	Comfort	Compact	Comfort	Compact		
Homogeneous Flooring (Evercare™)	Homogeneous Flooring (PUR)	Premium Comfort	Premium Compact	Taralay Libertex	Taralay Impression Comfort	Taralay Initial Comfort	Taralay Impression Compact	Taralay Initial Compact	Timberline	Tarastep	Attraction®	GTI Max	GTI EL5

### HEALTHCARE - HOSPITAL - CLINIC

Reception	•			•									
Corridors	•		•	•									
Waiting room	•		•	•	•		•	•					
Bedroom	•		•		•		•	•					
Bathroom - Toilets													
Carerom - Medical - Sick bay	•		•	•	•		•	•					
Rehabilitation room			•		•								
Surgery	•		•	•	•		•	•					
Theatre block	•		•	•									
Intensive care unit	•		•	•									
Radiotherapy - Laboratory	•			•									
Laundry - Store room											•	•	•
Stairs										•			

### RETIREMENT HOME

Reception	•			•	•			•	•				
Corridors	•		•	•	•			•	•				
Bedroom	•		•	•	•	•		•	•				
Bathroom - Toilets													
Living room			•		•	•		•	•				
Laundry - Store room											•	•	•

### OFFICE - ADMINISTRATION

Reception	•			•	•			•					
Office			•		•	•		•	•				
Bathroom - Toilets													
Meeting room - Board room			•		•	•		•	•				
Computer room													•
Stairs										•			

- GERFLOR's recommendation
- Other possible solutions





# GERFLOR SPECIFICATIONS

## EDUCATION - INDUSTRY - HOTEL - RESTAURANT



MIPOLAM HOMOGENEOUS		PREMIUM		TARALAY MULTILAYERED						TECHNICAL TILES			
Compact	Compact	Comfort	Compact	Textile backing	Comfort	Compact	Compact	Comfort	Compact	Compact			
Homogeneous Flooring (Evercare™)	Homogeneous Flooring (PUR)	Premium Comfort	Premium Compact	Taralay Libertex	Taralay Impression Comfort	Taralay Initial Comfort	Taralay Impression Compact	Taralay Initial Compact	Timberline	Tarastep	Attraction®	GTI Max	GTI EL5

EDUCATION													
Reception	•		•	•	•				•	•			
Corridors	•		•	•	•				•	•			
Classroom	•		•		•	•		•	•				
Dormitory room					•	•	•		•	•			
Changing room													
Bathroom - Toilets													
Meeting - Library			•		•	•		•	•				
Computer room			•		•	•							•
Laboratory	•			•			•	•					•
Student's residence					•	•	•			•			
Student's refectory	•		•		•								
Multipurpose room - Hall	•		•		•								
Stairs										•			
INDUSTRY													
Clean room / Laboratory	•			•									•
Changing room	•			•									
Computer room													•
Production	•			•								•	
Stocking and Packaging areas												•	
Stairs										•			
HOTEL - RESTAURANT													
Reception					•			•	•				
Bedroom					•		•						
Bathroom - Toilets													
Restaurant - Bar					•			•	•				
Conference - Exhibition	•			•	•			•	•				
Cinema - Show - Theatre			•			•							
Stairs										•			

- GERFLOR's recommendation
- Other possible solutions

# EDUCATION - INDUSTRY - HOTEL - RESTAURANT

CREATION LVT						TECHNICAL SOLUTIONS			SAFETY FLOORING					DLW LINO		
Comfort	Compact	Compact	Compact	Compact		Compact	Compact		Comfort	Compact	Compact	Compact	Compact	Acoustic	LCH	
Saga <sup>2</sup>	Creation 70 Connect	Creation 70	Creation 55	Creation 30	TopSilence Design	EL5/EL7 solutions (Static control flooring)	Shower system	Wall covering	Tarasafe Ultra Comfort	Tarasafe Ultra H2O	Tarasafe Ultra / Geo / Design (SparClean®)	Tarasafe Standard	Tarasafe Plus / Super	Linoleum Compact	Linoleum Acoustic	Linoleum Technical Solutions
	•										•					
	•							•								
•	•															
							•		•	•	•	•				
							•	•	•	•	•	•				
•						•										
						•		•			•					
							•									
								•								
						•		•								
						•		•			•	•	•			
						•		•			•	•	•			
•	•	•														
		•	•													
•		•					•	•	•	•	•	•				
		•														
		•														



# GERFLOR SPECIFICATIONS

## RETAIL - HOUSING - KITCHEN



MIPOLAM HOMOGENEOUS		PREMIUM		TARALAY MULTILAYERED						TECHNICAL TILES		
Compact                  Compact		Comfort                  Compact		Textile backing                  Comfort                  Compact			Comfort			Compact		
Homogeneous Flooring (Evercare™)	Homogeneous Flooring (PUR)	Premium Comfort	Premium Compact	Taralay Libertex	Taralay Impression Comfort	Taralay Initial Comfort	Taralay Impression Compact	Taralay Initial Compact	Tarastep	Attraction®	GTI Max	GTI EL5

RETAIL												
Shop	•			•							•	
Department store				•							•	
Supermarket				•							•	
Cafeterias			•	•		•						
Stocking areas											•	
Stairs									•			
HOUSING												
Dry Private room					•		•					
Damp Private room							•					
Reception area - Corridor - Landing					•		•			•		
Other private home												
KITCHEN												
Collective kitchens												
Food preparation areas - Canteen												

- GERFLOR's recommendation
- Other possible solutions

INSTALLATION & MAINTENANCE INSTRUCTIONS on [gerflor.com](http://gerflor.com)

# RETAIL - HOUSING - KITCHEN

CREATION LVT						TECHNICAL SOLUTIONS			SAFETY FLOORING					DLW LINO		
Comfort	Compact	Compact	Compact	Compact		Compact	Compact		Comfort	Compact	Compact	Compact	Compact	Compact	Acoustic	LCH
Saga <sup>2</sup>	Creation 70 Connect	Creation 70	Creation 55	Creation 30	TopSilence Design	EL5/EL7 solutions (Static control flooring)	Shower system	Wall covering	Tarasafe Ultra Comfort	Tarasafe Ultra H <sub>2</sub> O	Tarasafe Ultra / Geo / Design (SparClean®)	Tarasafe Standard	Tarasafe Plus / Super	Linoleum Compact	Linoleum Acoustic	Linoleum Technical Solutions
	•	•	•													
		•	•													
•	•	•	•													
				•	•											
				•			•		•	•	•	•				
	•								•		•					
				•	•		•									
								•					•			
								•					•			





# GERFLOR WEB SITE

**NEW DESIGN,  
NEW NAVIGATION!**

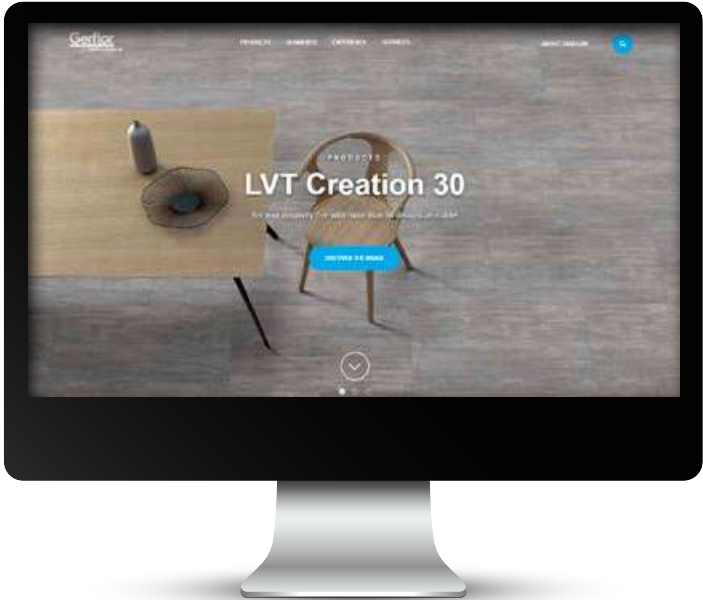

A website you can **access on your tablet or smartphone** everywhere!



Follow us on social media!

**Gerflor** Be connected!

#Gerflor

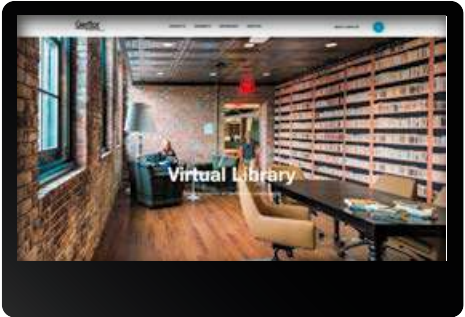

**1 VIRTUAL LIBRARY**  
Access to **all commercial and technical documentation** that will help you developing your projects.

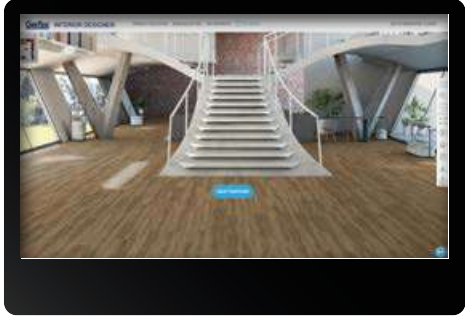

**2 INTERIOR DESIGNER**  
The **Interior Designer** provide you a real time simulation of the floor selected either in your own photo or in a pictures' gallery.



**3 STORE LOCATOR**  
Access to our **distributor partners list** and select the closest one.



**WE CARE | WE ACT.** Our commitments for a sustainable future



**CARBON FOOTPRINT\***

-20% kg CO<sub>2</sub> equivalent/m<sup>2</sup> between 2020 and 2025



**BIOSOURCED CONTENT\*\***

10% by 2025



**RECYCLED CONTENT**

30% by 2025



**ADHESIVE FREE\*\*\***

35% by 2025



**ANNUAL VOLUME RECYCLED**

60,000 t by 2025

\* Scopes 1 & 2 defined in the GHG protocol \*\* % of activity with biosourced materials \*\*\* % of activity with adhesive free solutions

